



JONNESWAY®

Ferramentas Profissionais, Manuais e Pneumáticas

2023

Ferramentas Profissionais Manuais e Pneumáticas



De profissionais
para profissionais

2023

 JONNESWAY®



JONNESWAY®

Ferramentas Profissionais Manuais e Pneumáticas



Este catálogo anula e substitui todas as edições anteriores.
Todos os preços apresentados nesta tabela estão sujeitos a IVA à taxa legal em vigor.

A Jonnesway está em constante desenvolvimento dos seus produtos, portanto, os modelos, composições, características técnicas, físicas, design e preços podem ser alterados, substituídos ou mesmo retirados deste catálogo sem aviso prévio e sem obrigação de efetuar qualquer alteração nas ferramentas e/ou equipamentos vendidos anteriormente. As capacidades indicadas para os produtos, são as que resultaram dos ensaios realizados nos laboratórios da Jonnesway, não sendo portanto contratuais.



www.jonneswaytools.com



facebook.com/jonneswaytools



Lusilectra
Salvador Caetano

Catálogo versão 3.6
Entra em vigor em janeiro de 2023

Carros e Composições de Ferramentas

Composições de ferramentas 7-18

Carros para ferramentas 19-21

Caixas, tornos e complementos para carros 21-24

Ferramenta Manual

Tabuleiros de ferramenta 26-41

Ferramenta de aperto 42-87

Alicates 88-95

Chaves 96-110

Martelos, punções e escopros 111-113

Corte, desbaste e medida 114-115

Ferramenta isolada a 1 000V 116-120

Ferramenta Especial Mecânica

Mecânica 122-158

Motociclos 159-160

Chapeiro 160-165

Pesados 165-166

Ferramenta Pneumática

Ferramenta pneumática 168-186

Acessórios para redes de ar comprimido 187-189

Merchandising

Merchandising 192-195

Outros Equipamentos

Outros equipamentos 198-201





JONNESWAY®

Ferramentas Profissionais
• Manuais • Pneumáticas •
específicas para automóvel, motociclos e pesados





JONNESWAY®

Carros e Composições de Ferramentas



**Composições
de ferramentas**

**Caixas, tornos e
complementos
para carros**



**Carros para
ferramentas**



JONNESWAY®

Painéis de Ferramentas em Espuma

Novo

Principais características:

- Painel vertical
- Optimização de espaços
- Personalização
- Organização de ferramentas
- Produtividade



(Imagem ilustrativa - painel não inclui a ferramenta)

Painel de ferramentas personalizável em espuma para aplicação na vertical.

Estes painéis totalmente personalizáveis tanto nas medidas/ dimensões do painel, como também nas composições de ferramenta que cada painel deverá conter.

Preço para painel com outras medidas e composições - SOB CONSULTA

EVA POWER

Composição de ferramentas profissionais em tabuleiros EVA

TABULEIROS

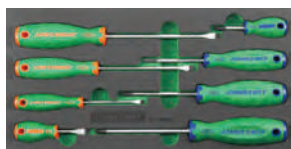

D71PP08KV



P011804KV



S04H4144KV



H10MT08KV



P32M105KV



S29H4141KV



H10MB08KV



MHS08KV



M09103KV



S03A4122KV

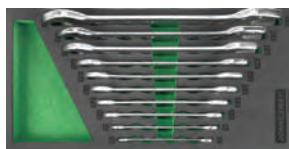

W25110KV



S04H2132KV

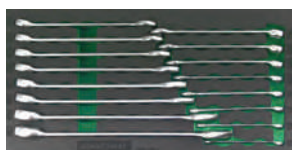

W26116KV



M63113KV

Composição: 218 peças

- S04H4144KV Jogo de chaves de caixa com roquete de 1/2" e 1/4" - 44 peças
- S04H2132KV Jogo de chaves de vela, extensões e bits - 32 peças
- W26116KV Jogo de chaves mistas - 16 peças
- S03A4122KV Jogo de chaves de impacto de 1/2" - 22 peças
- M63113KV Jogo de punções, saca troços e talhadeiras - 13 peças
- W25110KV Jogo de chaves de bocas - 10 peças
- P011804KV Jogo de alicates - 4 peças

- S29H4141KV Jogo com chave de travões e bits - 41 peças
- H10MB08KV Jogo de chaves hexagonais de punho - 8 peças
- H10MT08KV Jogo de chaves torx de punho - 8 peças
- M09103KV Jogo de martelos - 3 peças
- P32M105KV Jogo de alicates de freios - 5 peças
- MHS08KV Jogo com serra, régua, x-ato e fita métrica

CARROS



C-6DWB1



C-7DC2B



EVA POWER-V	Cor: verde		2 200.00€
EVA POWER-C	Cor: cinza		2 200.00€

EVA POWER BLACK	Cor: preto		1 940.00€
-----------------	------------	--	-----------

MEC SOLUTION

Composição de ferramentas profissionais, ajustável às suas necessidades

Adicione **3 TABULEIROS EVA**, sendo **1 do TIPO A** e **2 do TIPO B** e finalmente escolha o carro que vá de encontro das suas necessidades

TABULEIROS TIPO

A



S04H42165SV

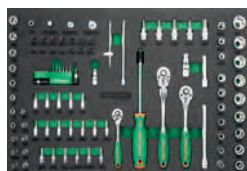

S04H31945SV

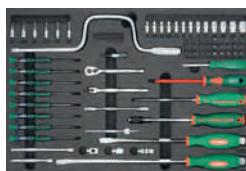

S04H21845SV



S04H42955SV



S04H461215SV

TABULEIROS TIPO

B



W26234315V



D7371285V



H101215V

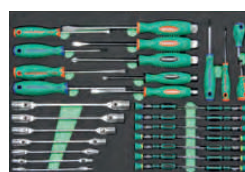

D7371345V

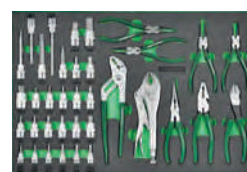

P827365V



P827145V



W235595V

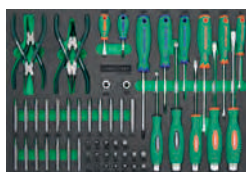

D711575V



W261345V

CARROS

CARRO



C-6DWB1



C-7DC2B



MEC SOLUTION-V	Cor: verde		1 740.00€
MEC SOLUTION-C	Cor: cinza		1 740.00€

MEC SOLUTION BLACK	Cor: preto		1 610.00€
--------------------	------------	--	-----------

MEC POWER

Composição de ferramentas profissionais, em tabuleiros rígidos de polipropileno

TABULEIROS



Composição: 198 peças

- AG010002SP Jogo 4 alicates de freios
- P018SP1 Jogo 3 alicates (universal/ pontas/ corte)
- AG010026SP Jogo 2 martelos e cinzeis
- D71PP08SP Jogo 8 chaves fenda/ philips
- H01SM109S Jogo 9 chaves macho hexagonal
- H10MT08SP Jogo 8 chaves torx dupla punho
- M645114SP Jogo serra, punções e chave inglesa
- P2710SP Jogo alicate pressão e alicate ajustável

- S04H2125SP Jogo chaves caixa com roquete 1/4"
- S04H4125SP Jogo chaves caixa com roquete 1/2"
- S06H427SP Jogo bits caixa 1/2" e 3/8"
- S29H4140SP Jogo bits 1/2" e 3/8"
- W25110SP Jogo 10 chaves de bocas
- W26116SP Jogo 16 chaves mistas
- W23108SP Jogo 8 chaves luneta 75°

CARROS



C-6DWB1



C-7DC2B

MEC POWER 19V Cor: verde 1 900.00€

MEC POWER 19C Cor: cinza 1 900.00€

BLACK POWER 19 Cor: preto 1 640.00€



MEC POLEGADAS Composição de ferramenta de polegada

Novo

TABULEIROS



Composição: 114 peças
Tabuleiro com
 Jogo 17 chaves hexagonais longas 1/16" a 3/4"
 Jogo 14 chaves caixa de impacto longas 3/8" a 1-1/4"
 Chave inglesa
 Reparador de roscas

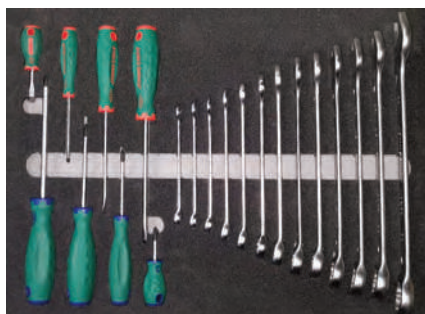

Tabuleiro com
 Jogo de 8 chaves fenda/ phillips
 Jogo de 14 chaves mistas boca/ luneta 3/8" a 1-1/4"

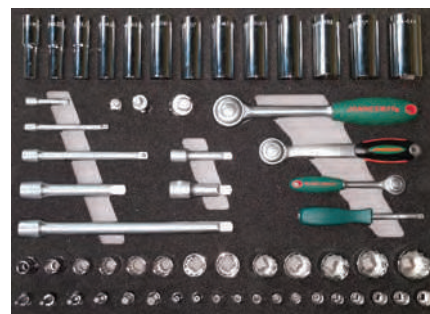

Tabuleiro com
 Jogo de 13 chaves de caixa 1/2 longas 7/16" a 1-1/4"
 Jogo de 13 chaves de caixa 1/2 de 7/16" a 1-1/8"
 Jogo de 6 bits hexagonais 3/8" 5/32"; 3/16"; 7/32";
 1/4"; 5/16" e 3/8"
 Jogo 13 chaves de caixa 1/4" SUPERTECH 5/32" a 9/16"
 3 Roquetes 1/4"; 3/8"; 1/2" e 1 punho 1/4"
 7 Extensões e 3 adaptadores

CARROS



C-DC2B



MEC POLEGADAS

Cor: preto

1 500.00€

MEC PROF20

Composição de ferramentas profissionais para mecânico



TABULEIROS

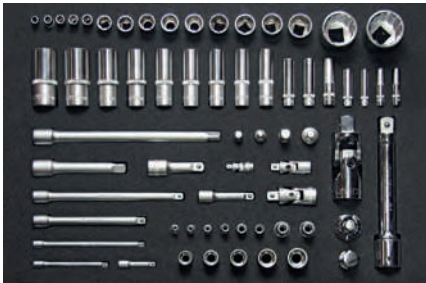

Composição: 210 peças

Tabuleiro com

Jogo chaves de caixa longa 1/4" e 1/2" de 6 a 27mm
 Jogo chaves de caixa 1/4", 1/2" e 3/4" de 6 a 36mm
 Jogo extensões de 1/4", 1/2" e 3/4"
 Adaptadores
 Cardans
 Jogo chaves de caixa torx de 1/4" e 1/2" de E5 a E 24

Tabuleiro com

Jogo chaves fenda, Philips e torx com punho
 Chave de caixa com punho

Tabuleiro com

Jogo alicates longos, universal, pontas, corte, pressão, ajustável
 Chave de filtros

Tabuleiro com

Jogo de roquetes 1/4", 3/4", 1/2", 3/8"
 Roquete extensível de 1/2"
 Jogo bits curtos e longos 1/2"
 Jogo chaves de caixa torx de 1/2"
 Jogo chaves ribe de 1/2"
 Jogo chaves estriadas de 1/2"
 Jogo de chaves de hexagonais 1/2"

Tabuleiro com

Jogo chaves mistas de 6 a 34mm

Tabuleiro com

Jogo chaves luneta de 10 a 22mm
 Jogo alicates de freios
 Jogo de chaves de hexagonais curtas
 Apalpa folgas
 Martelo pena esférica
 Chave inglesa

CARROS



C-6DWB1



C-7DC2B



MEC PROF20-V

Cor: verde



2 426.00€

MEC PROF20-C

Cor: cinza



2 426.00€

MEC PROF20-BLACK

Cor: preto



2 210.00€

ELECTR. 1000volts

Composição de ferramentas profissionais isolada a 1000volts

TABULEIROS

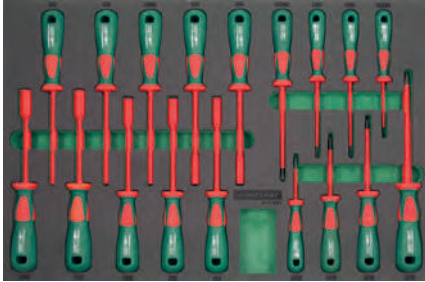

DV4118SV

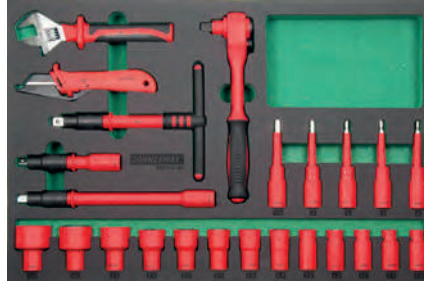

S03V4124SV

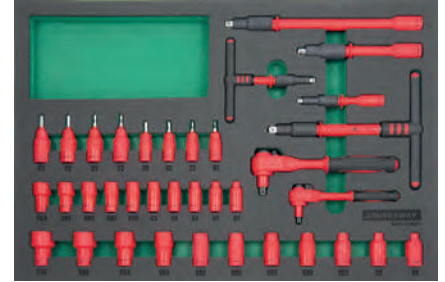

S03V3136SV



W25V1125SV

Composição: 103 peças

DV4118SV

Tabuleiro com 18 chaves isoladas

- 4 Chaves de fenda
- 4 Chaves phillips
- 10 Chaves de caixa de punho

S03V3136SV

Tabuleiro com 36 peças 1/4" e 3/8"

- 2 Roquete 1/4" e 3/8"
- 2 Cabo T de 1/4" e 3/8"
- 1 Extensão 100mm de 1/4"
- 10 Chaves de caixa 1/4"
- 4 Bits de caixa 1/4"
- 2 Extensões 3/8"
- 11 Chaves de caixa 3/8"
- 4 Bits de caixa 3/8"

S03V4124SV

Tabuleiro com 24 peças 1/2"

- 1 Roquete
- 1 Cabo T
- 2 Extensões
- 13 Chaves de caixa
- 5 Bits de caixa
- 1 Chave inglesa
- 1 X-ato

W25V1125SV

Tabuleiro com 25 peças

- 9 Chaves de bocas
- 13 Chaves de luneta
- 1 Alicate universal
- 1 Alicate de corte
- 1 Alicate de pontas

CARROS



C-6DWB1



C-7DC2B

ELECTR. 1000-V Cor: verde 2 640.00€

ELECTR. 1000-C Cor: cinza 2 640.00€

ELECTR. 1000 BLACK Cor: preto 2 380.00€

HV 1000V

Composição básica de ferramentas profissionais isolada a 1000volts



TABULEIROS



Composição: 43 peças

Tabuleiro com

Jogo de alicate de pontas, universal e de corte
 Jogo chaves fenda e Philips
 Jogo chaves de caixa com punho
 Busca polos



Tabuleiro com

Multímetro digital
 Jogo de extensões
 Roquete
 Navalha
 Jogo chaves de caixa 1/2" de 8 a 22mm
 Jogo chaves luneta de 8 a 14mm
 Jogo chaves bocas de 8 a 14mm
 Jogo chaves hexagonais de 4 a 8mm
 Chave ajustável

CARROS



C-6DWB1



C-7DC2B



HV1000V-V	Cor: verde		1 875.00€
HV1000V-C	Cor: cinza		1 875.00€

HV1000V-BLACK	Cor: preto		1 650.00€
---------------	------------	---	-----------



ELECTR

Composição de ferramentas profissionais para electricista

TABULEIROS

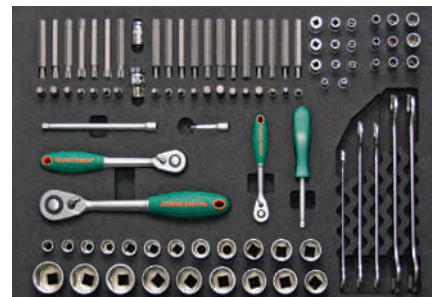
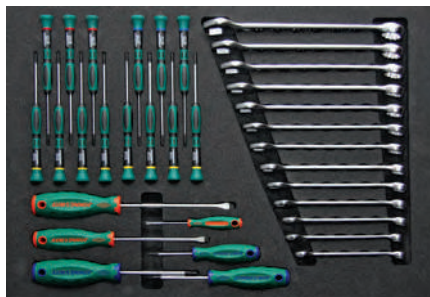

Composição: 144 peças

Tabuleiro com

Jogo alicates universal, pontas e corte
Mini alicates
Alicate de descarnar
Alicate de cravar terminais

Tabuleiro com

Jogo chaves mistas de 10 a 22mm
Jogo chaves de precisão
Chaves fenda e Philips

Tabuleiro com

Jogo de bits com adaptadores
Jogo chaves de boca perfil fino de 10 a 19mm
Jogo chaves caixa 1/2" de 17 a 30mm
Jogo chaves de caixa 3/8" de 11 a 16mm
Jogo de roquetes e extensões

Tabuleiro com

Bandeja magnética
Gambiarra leds
Multímetro digital
X-acto
Tesoura
Raspador com lâminas

CARROS



C-6DWB5



C-7DC2B



ELECTR-V

Cor: verde



2 080.00€

ELECTR-C

Cor: cinza



2 080.00€

ELECTR-BLACK

Cor: preto



1 820.00€

CHAPEIRO 20

Composição de ferramentas profissionais para chapeiro (ferro)



TABULEIROS



Composição: 55 peças

Tabuleiro com

Lima de chapéiro
Jogo de martelos chapeiro
Chaves cavilhas

Tabuleiro com

Jogo alicates universal, de pontas e de corte
Desandador de percussão
Jogo alicates de pressão

Tabuleiro com

Jogo de ventosas
Jogo chaves fenda e Philips de pancada
Jogo de ferramentas para remoção de frisos plásticos

Tabuleiro com

Jogo encontradores para ferro
Kit remoção de vidros para brisas

CARROS



C-4DWA1



C-7DC2B



CHAPEIRO20-V

Cor: verde



1 780.00€

CHAPEIRO20-C

Cor: cinza



1 780.00€

CHAPEIRO20- BLACK

Cor: preto



1 735.00€



CHAPEIRO ALU

Composição de ferramentas profissionais para chapeiro (alumínio)

TABULEIROS

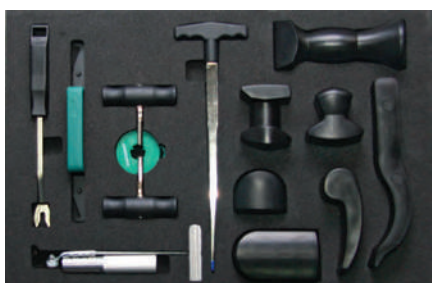

Composição: 57 peças

Tabuleiro com

Lima de chapeiro
Jogo de martelos chapeiro
Chaves cavilhas

Tabuleiro com

Jogo alicates universal, de pontas e de corte
Desandador de percussão
Jogo alicates de pressão

Tabuleiro com

Jogo de ventosas
Jogo chaves fenda e Philips de pancada
Jogo de ferramentas para remoção de frisos plásticos

Tabuleiro com

Jogo encontradores para alumínio
Kit remoção de vidros para brisas

CARROS



C-4DWA1



C-7DC2B



CHAPEIROALU-V

Cor: verde



1 830.00€

CHAPEIROALU-C

Cor: cinza



1 830.00€

CHAPEIROALU-BLACK

Cor: preto



1 785.00€

PINTOR20 Composição de ferramentas profissionais para pintor

TABULEIROS



Composição: 47 peças

Tabuleiro com

Jogo de espátulas remoção de frisos
Espelho auxiliar de reparação de
mossas
Jogo chaves para remoção de
cavilhas e molas

Tabuleiro com

Pistola pintura
Base para lixa
Jogo de 4 espátula
Lixadora orbital
Saca terminais de cabo de baterias

Tabuleiro com

Jogo chaves luneta de 6 a 32mm
X-acto
Jogo chaves fenda e Philips

Tabuleiro com

Jogo de 6 ventosas e acessórios

CARROS



C-4DWA1



C-7DB2B

PINTOR20-V

Cor: verde



1 710.00€

PINTOR20-C

Cor: cinza



1 710.00€

PINTOR20-BLACK

Cor: preto



1 665.00€

MEC PESADOS

Composição de ferramentas profissionais para pesados

TABULEIROS



Composição: 162 peças

Tabuleiro com

Jogo chaves caixa de 1/2" de 8 a 34mm com roquete e extensão
 Jogo chaves torx macho 1/2" de T30 a T80
 Jogo chaves macho hexagonais de 1/2" de H5 a H19
 Cardan
 Rabo de força

Tabuleiro com

Jogo chaves caixa de impacto longas de 1/2" e 3/4" de 10 a 46mm
 Adaptadores
 Extensão
 Cardan

Tabuleiro com

Jogo de martelos, marreta e alicates

Tabuleiro com

Jogo chaves fenda e Philips de pancada
 Jogo chaves Hexagonais de impacto, chave de filtro

Tabuleiro com

Jogo chaves luneta de 6 a 32mm
 Jogo chaves de bocas de 6 a 32mm

Tabuleiro com

Jogo chaves de 3/4" de 19 a 50mm com extensões, adaptadores, cardan e roquete

Tabuleiro com

Jogo chaves mistas de 20 a 46mm

CARROS



MEC PESADOS 20A

Cor: verde



3 790.00€

MEC PESADOS 20B

Cor: verde



3 650.00€

C-1DM1

395.00€

Gaveta lateral de apoio de laptop/ tablet até 14"
Adicional para carros de ferramentas
Dimensões gaveta: 410x285x70



* Exemplo de aplicação em carro de ferramentas

C-3DW5

855.00€

Carro vazio para ferramenta

Dimensões totais: 670x460x960mm
Peso: 54,2kg
3 Gavetas de 576x380x75mm
1 Arrumos com 2 portas de 603x404x478mm



C-4DWA1

Cor: verde 

780.00€

C-4DWA1G

Cor: cinza 

780.00€

Carro vazio para ferramenta com 4 gavetas

Tampo especial preparado para banca de trabalho

Dimensões totais: 670x460x795mm
2 Gavetas de 579x380x56mm
1 Gaveta de 579x380x123mm
1 Gaveta de 579x380x179mm



C-6DWB1

Cor: verde 

958.00€

C-6DWB1G

Cor: cinza 

958.00€

Carro vazio para ferramenta com 6 gavetas

Tampo especial preparado para banca de trabalho

Dimensões totais: 670x460x967mm
4 Gavetas de 579x380x56mm
1 Gaveta de 579x380x123mm
1 Gaveta de 579x380x179mm



C-6DWB5

936.00€

Carro vazio para ferramenta com 6 gavetas

Tampo revestido a plástico e suporte para ferramenta

Dimensões totais: 670x460x967mm
4 Gavetas de 579x380x56mm
1 Gaveta de 579x380x123mm
1 Gaveta de 579x380x179mm



C-7DC2B

Cor: preto 

680.00€

Carro vazio para ferramenta com 7 gavetas

Dimensões totais: 670x460x963mm
5 Gavetas de 576x380x75mm
2 Gavetas de 576x380x154mm
Peso total: 57kg
Capacidade de carga: 140kg/roda
Dimensão rodas: 127x25,5mm



C-7DS1

1 260.00€

Carro vazio para ferramenta com 7 gavetas

Tampo em aço

Dimensões totais: 710x500x967mm
1 Painel lateral perfurado
1 Painel lateral para compartimentos de arrumos
4 Rodas, 2 direcionais com travão
Peso total: 74,5kg
Capacidade de carga: 160kg/roda



* As caixas laterais são opção

C-7DW9

1 115.00€

Carro vazio para ferramenta com 7 gavetas

Sistema de segurança, abertura de 1 só gaveta

Dimensões totais: 670x460x967mm

5 Gavetas de 576x380x75mm

2 Gavetas de 576x380x154mm

Peso total: 74,5kg

Capacidade de carga: 75kg/roda

Dimensão rodas: 127x50,8mm



C-7 TOWER

1 500.00€

Carro vazio com 13 gavetas

Dimensões totais: 670x460x1 334mm

5 Gavetas de 576x380x75mm

2 Gavetas de 576x380x154mm

Caixa superior

3 Gavetas de 170x275x50mm

2 Gavetas de 569x275x50mm

1 Gaveta de 569x275x75mm



C-10DW42

2 090.00€

Carro grande vazio para ferramenta com 10 gavetas

Dimensões totais: 1 070x460x981mm

1 Compartimento arrumação de 316x404x1 150mm

5 Gavetas de 288x380x75mm

2 Gavetas de 576x380x154mm

1 Gaveta de 288x380x154mm

1 Gaveta de 576x380x154mm

1 Gaveta de 928x380x173mm



C-A16W

620.00€

Armário com 7 gavetas

Inclui 2 rodas para acoplamento aos carros C-7/ C-6

5 Gavetas de 288x380x75mm

2 Gavetas de 288x380x154mm



C-13DW53

2 730.50€

Carro grande vazio para ferramenta com 13 gavetas

Dimensões totais: 1 358x460x1 150mm

10 Gavetas de 576x380x75mm

2 Gavetas de 579x380x154mm

1 Gaveta de 1 216x380x173mm



C-A17W

Cor: verde



390.00€

C-A17WG

Cor: cinza



390.00€

Armário com 1 porta

Inclui 2 rodas para acoplamento aos carros C-7/ C-6



C-T3

640.70€

Carro vazio para ferramenta com 3 gavetas

Tampo de abrir

Dimensões totais: 780x520x884mm



Novo

C-3DH1

102.30€

Caixa vazia para ferramenta 3 divisões

Dimensões totais: 250x320x250mm

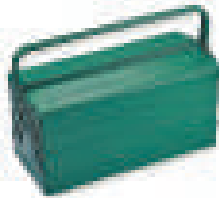

C-3DH2

108.70€

Caixa metálica vazia para ferramenta com 5 compartimentos

Dimensões totais: 470x240x220mm



Caixas, tornos e complementos para carros

C-3DH262

470.00€

Caixa metálica para ferramenta com 5 compartimentos - 62 peças

Dimensões totais: 470x220x350mm

Composição

- P106 Alicates de corte
- P116 Alicates de pontas
- P087 Alicates universais
- D70 Jogo de 6 chaves fenda/ phillips
- W26 Jogo de 18 chaves mistas
- R2904 Roquete de 1/2"
- S04H41 Jogo de 18 chaves de caixa
- S15H472 Adaptador
- S24H4 Extensões
- S22H41450 Cabo articulado 450mm
- S23H41300 Cabo T corrediço 300mm
- S21H4150 Extensão
- S17H4121 Chave de velas 21mm
- H03SM109S Jogo de chaves hexagonais



C-3DH262V

540.00€

Novo

Caixa para ferramenta em EVA - 62 peças

Dimensões totais: 470x220x350mm

Composição

- P106 Alicates de corte
- P116 Alicates de pontas
- P087 Alicates universais
- D70 Jogo de 6 chaves fenda/ phillips
- W26 Jogo de 18 chaves mistas
- R2904 Roquete de 1/2"
- S04H41 Jogo de 18 chaves de caixa
- S15H472 Adaptador
- S24H4 Extensões
- S22H41450 Cabo articulado 450mm
- S23H41300 Cabo T corrediço 300mm
- S21H4150 Extensão
- S17H4121 Chave de velas 21mm
- H03SM109S Jogo de chaves hexagonais



C-3DH5

199.40€

Caixa metálica vazia para ferramenta com 3 gavetas

Compartimento no topo

Dimensões totais: 535x220x290mm

3 Gavetas de 505x195x45mm



C-T12

284.60€

Carro com 3 prateleiras

Dimensões totais:

Comprimento: 716mm

Largura: 410mm

Altura: 880mm

Peso: 20kg

Rodas: 4 (2 fixas+2 direcionais)



Novo

C-3DH6

78.00€

Caixa vazia para Ferramenta

Dimensões totais: 355x160x242mm



C-5CD

378.90€

Caixa metálica vazia para ferramenta com 5 malas

Dimensões totais: 431x307x381mm

5 Malas de 48x245x55mm



C-6DA4

409.40€

Caixa metálica vazia para ferramenta com 6 gavetas

Compartimento no topo com várias divisórias

Dimensões totais: 660x307x374mm

3 Gavetas de 172x270x41mm

2 Gavetas de 572x270x31mm

1 Gaveta de 572x270x65mm



C-6DA494

999.00€

Caixa de ferramenta com 6 gavetas - 98 peças

Compartimento no topo com várias divisórias

Dimensões totais: 660x307x374mm

Composição:

AG10002SC

D376514SC

R4811SC

P0813SC

S04H5129SC

V11011SC

W25117SC

W27AT02SC



C-A456 91.40€

Tampo plástico para carros de ferramenta

Aplicável aos carros C-4/ C-6 e C-7



C-A9 69.10€

Base para torno e suporte para rolo de papel



C-A27 64.80€

Tampo em acrílico resistente ao impacto para carros de ferramentas

Aplicável somente aos carros C-5DW/ C-6DW e C-7DW



C-7DW1-TS 132.60€

Tampo completo para carros de ferramentas

Aplicável somente aos carros C-5DW/ C-6DW e C-7DW

Composição

1 Tampo acrílico resistente ao impacto

1 Base metálica de apoio

1 Revestimento EVA de 2mm



C-A31 22.80€

Suporte lateral para chaves em T para fixação



Caixas, tornos e complementos para carros

C-A3 Cor: verde 25.60€

Pega para carro de ferramenta

Aplicável a C-4DW; C-6DW e C-7DW



C-A3-B Cor: preto 25.60€

Pega para carro de ferramenta

Aplicável a C-7DB2 e C-7DC2

C-A3G Cor: cinza 25.60€

Pega para carro de ferramenta

Aplicável a C-4DW; C-6DW e C-7DW

C-BS

Jogo de calhas direita e esquerda, para gavetas de carros e caixas

Ref.	Aplicação	Preço
C-BS Kit1	Carros: C-4DW/ C-5DW/ C-6DW/ C-7DW	24.60€
C-BS Kit2	Caixas: C-6DA4	15.60€
C-BS Kit3	Carros: C-10DW/ C-13DW	24.50€



C-PC

Canhão de fechadura

Ref.	Aplicação	Preço
C-PC1	C-6DA4	8.80€
C-PC2	C-5/ C-6/ C-7/ C-10/ C-13	9.70€
C-PC3	C-4	14.70€



C-PC4 17.20€

Canhão de fechadura para chaves tubulares

Inclui 2 chaves.



C-WHEEL

Rodas

Ref.	Tipo	Aplicação carro	Preço
C-WHEEL1	fixa	C-6/ C-7	21.10€
C-WHEEL2	travão	C-6/ C-7	27.30€
C-WHEEL5	fixa	C-4/ C-5/ C-7DB2	18.60€
C-WHEEL6	travão	C-4/ C-5/ C-7DB2	26.50€
C-WHEEL8	fixa	C-T3/ C-12	15.90€
C-WHEEL9	travão	C-T3/ C-12	17.70€



C-A

Torno de bancada

Ref.	Abertura (mm)	Peso (kg)	Preço
C-A7*	76	6	115.90€
C-A8*	101	7,25	141.50€
C-A10	127	10,2	183.90€
C-A11	152	14	217.30€
C-A12	203	18	299.10€
C-A13	254	24	373.30€

* Aplicável em carro de ferramenta (necessário suporte C-A9)



C-B

Torno de bancada com dupla rotação

Rotação 360° da base do torno
Rotação 360° da cabeça do torno

Ref.	Abertura (mm)	Peso (kg)	Preço
C-B5	127	17	226.20€



C-A2501S

29.00€

Conjunto de caixas plásticas para gavetas de carros de ferramenta

Composição
12 Caixas 93x93x43mm
4 Caixas 283x93x43mm

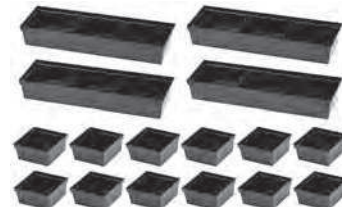

C-APB

30.60€

Conjunto de caixas plásticas para gavetas de carros de ferramenta

Composição
8 Caixas 283x93x43mm





JONNESWAY®

Ferramenta Manual



**Tabuleiros de
ferramenta**



Chaves



**Ferramenta
de aperto**



**Martelos, punções
e escopros**



Alicates



**Corte, desbaste
e medida**



AG010002SP

57.90€

Jogo de 4 alicates de freios

Composição:

AG010002 Alicates de freios interiores

AG010005 Alicates de freios interiores de ponta curva

AG010008 Alicates de freios exteriores

AG010011 Alicates de freios exteriores de pontas curvas 90°

A



AG010026SP

66.90€

Jogo de martelos e talhadeiras

Composição:

M09300 Martelo tipo alemão 300g

M11035 Martelo com batentes de borracha 400g

M61 Jogo de 3 talhadeiras

A



AG010150SC

137.80€

Jogo de 8 alicates de freios

Composição:

4 Alicates de pontas direitas

4 Alicates de pontas curvas

B

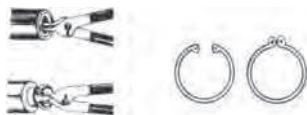

AG10001SP

138.00€

Jogo de machos e caçonetes

Composição:

17 Machos manuais: M3 a M12

17 Caçonetes: M3 a M12

1 Porta caçoneto

1 Desandador de machos

1 Punho desandador

B



AI10001SP

244.00€

Jogo de ferramentas para substituição de válvulas da cabeça do motor

Composição:

AN010064 Compressor de válvulas da cabeça do motor

AI020056 Alicates para vedantes de válvulas

AI020099 Adaptador de mola de válvula

AI020100 Suporte de válvulas

AI010012A Removedor de pastilhas de válvula

B



AI10002SP

204.30€

Jogo de ferramentas para substituição da polie da correia da cambota

Composição:

AE310030 Saca de 2 pernas

AE10035-1 Complemento para 3 pernas

AN010038 Saca vedante

AI020087A Saca polie da cambota

B



AI10003SP

153.80€

Jogo de chaves de copo para filtros

Composição:

- 9 Chaves de copo para filtros
- 14 Chaves para bujão do carter
- 1 Chave de filtros

B

Description	
○ P P	90 :) LG
○ P P	* HCHDD WU
○ P P) LG
○ P P) IDW DDFID 3HKJ H W
○ P P	0 HUFHGH / DDFID
○ P P	90 : SXWQ SXGL9:
○ μ	* HCHDD WU
□ P P	90 : 5HCKOW \ MD
□ P P	84W s Q 3HKJ H W5HCKOWDIE V9 0'
□ P P) LG
□ P P	1 DADQ 6XEDUX
□ μ	+ QGD 0 D GD 5HCKOW6DEE 9 0'
□ P P	* HCHDD WU
△ P P	5HCKOW
7 %DU7 ' UYH	
P P 2 LG LOMURKDLQ μ2 LD	
) LOMURCS : UHCFK	
P P	* 0 1 DADQ 9 0' 0 D GD SXGL9: HW
P P	9: 3 UFKH 0 HUFHGH 90 : 7 \ MD
P P	0 D GD * HCHDD WU
P P	HW' UHMQ QJLH
P P	90 : 9: 90 : 0 0 0
P P	* 0 6DEE 6DMUQ
P P	* HCHDD WU
P P	0 HUFHGH
P P	90 : V4UHV

AN100002SP

238.50€

Jogo de 42 peças de ferramenta para travões

Este tabuleiro ocupa meia gaveta do carro de ferramentas.

C

D70105SP

46.80€

Jogo de 5 chaves fenda/ phillips impacto

Composição/ medidas em mm:

- | | | | |
|------|--------------------|------|--------------------|
| D70S | 3 Chaves de fenda: | D70P | 2 Chaves phillips: |
| | 6,5x125 | | PH 2x100 |
| | 8x150 | | PH 3x150 |
| | 9,5x175 | | |

A

D71PP08SP

42.90€

Jogo de 8 chaves fenda/ phillips

Composição/ medidas em mm:

- | | | | |
|------|--------------------|------|--------------------|
| D71S | 4 Chaves de fenda: | D71P | 4 Chaves phillips: |
| | 6,5x38 | | 2x38 |
| | 4x80 | | 1x80 |
| | 5,5x125 | | 2x100 |
| | 6,5x150 | | 3x150 |

A

Tabuleiros para composições em carros
D725N08SP

88.00€

Jogo de 8 chaves de caixa de punho

Composição:

Chaves de 6 a 13mm

C

H10MB08SP

52.90€

Jogo de 8 chaves macho hexagonal com extremidade esférica e punho

Composição/ medidas em mm:

- | | | |
|-------|---------|--------|
| H10MB | 2x100 | 5x150 |
| | 2,5x100 | 6X150 |
| | 3x100 | 8X200 |
| | 4x100 | 10X200 |

B

H10MT08SP

51.30€

Jogo de 8 chaves torx duplas tamperproof com punho

Composição/ medidas em mm:

- | | | |
|-------|---------|---------|
| H10MT | T10x100 | T27x150 |
| | T15x100 | T30X150 |
| | T20x100 | T45X200 |
| | T25x100 | T50X200 |

B

H20MT08SP

54.60€

Jogo de 8 chaves torx duplas de punho

Composição/ medidas em mm:

- | | | |
|--|---------|---------|
| | T10x110 | T27x145 |
| | T15x120 | T30X155 |
| | T20x125 | T45X185 |
| | T25x135 | T50X205 |

B

M09513SP

95.00€

Jogo de martelos e punções

Composição:

- M07016 Martelo com batentes de plástico
- M09500 Martelo de mecânico tipo "alemão"
- M63M106S Jogo saca troços cromados
- M64M105S Jogo punções e escopros cromados

A



M645114SP

96.40€

Jogo de serra, chave inglesa, punções e escopros

Composição:

- M63 6 Punções
- M64 4 Escopros
- W27AS10 Chave inglesa
- MHS100AG Serra

B



MTC101SP

245.10€

Jogo de ferramenta de medição

Composição/ medidas em mm:

- Paquímetro digital 150
- Esquadro metálico 300
- Régua metálica 300
- Compasso 200
- Micrómetro 0-25
- Micrómetro 25-50
- Lapiseira

B



P018SP1

74.70€

Jogo de 3 alicates e 7 chaves hexagonais

Composição:

- P018 Alicates universal
- P038 Alicates de corte diagonal
- P068 Alicates de pontas
- H01SM109S Chaves hexagonais

A



P018SP

62.40€

Jogo de 3 alicates

Composição:

- P018 Alicates universal
- P038 Alicates de corte diagonal
- P068 Alicates de pontas

A



P04704SP

72.40€

Jogo de 4 alicates de corte

Não utilizar em metal.

A



P0803SP

61.10€

Jogo de 3 alicates isolados

Composição:

- P087 Alicates universal
- P097 Alicates de corte diagonal
- P118 Alicates de pontas

A



P0903SP

70.60€

Jogo de 3 alicates isolados

Composição:

- P0118 Alicates universal
- P0918 Alicates de corte diagonal
- P1118 Alicates de pontas

A



P2710SP

44.20€

Jogo de 2 alicates

Composição:

- P2710 Alicates ajustável
- P32M10A Alicates de pressão

A



P2803SP
66.70€
Jogo de 2 alicates e chave inglesa

Composição:

- W27AS10** Chave inglesa
P2810 Alicates ajustável
P32M10A Alicates de pressão

A

S03A4122SP
103.60€
Jogo de 22 chaves de impacto 1/2"

Composição/ medidas em mm:

- S03A4** Chaves: 10; 11; 12; 13; 14; 16; 17; 19; 21; 22 e 24
S03AD4 Chaves: 10; 11; 12; 13; 14; 16; 17; 19; 21; 22 e 24

A

S04H2125SP
62.40€
Jogo de chaves de caixa com 24 peças de 1/4"

Composição/ medidas em mm:

- R3702** Roquete de 48 dentes
S04H2 Chaves de caixa: 4; 5; 5,5; 6; 7; 8; 9; 10; 11; 12 e 13
S04HD2 Chaves de caixa: 5; 6; 7; 8; 9; 10; 11; 12 e 13
S24H250 Extensão 50
S24H2150 Extensão 150
S26H2150 Punho

A

S04H3157SP
141.50€
Jogo de 8 chaves de caixa com 56 peças de 1/4" e 3/8"

Composição/ medidas em mm:

- R3702** Roquete 1/4" de 48 dentes
S04H2 Chaves 1/4": 4; 4,5; 5; 5,5; 6; 7; 8; 9; 10; 11; 12 e 13
S04HD2 Chaves 1/4": 8; 10; 12 e 13
S09H2 Bits hexagonais: 3; 4; 5 e 6
S07H2 Bits torx: T10; T15; T20; T25; T27 e T30
S10H2 Bits fendas: 4; 5,5 e 7
S11H2 Bits phillips: PH1; PH2 e PH3
S24H2 Extensões
 Adaptador de extensão
S16H302 Adaptador universal
 Punho
R3703 Roquete 3/8" de 48 dentes
S04H3 Chaves 3/8": 14; 15; 17; 18; 19; 20; 22 e 24
S04HD3 Chaves 3/8": 14; 15 e 17
S17H3 Chaves de velas: 16 e 21
S24H3 Extensões
 Adaptador extensão 3/8" - 1/2"
S15H356 Adaptador universal

B

S04H3536SP
120.30€
Jogo de chaves de caixa e chaves mistas com 36 peças de 3/8"

Composição/ medidas em mm:

- R3503** Roquete de 72 dentes
S04H3 Chaves de caixa: 6 a 22
S24H3 Extensões
 Adaptador de extensão 1/2" - 3/8"
S17H3 Chaves de velas: 16 e 21
S15H356 Adaptador universal
W26 Chaves mistas boca/ luneta: 7 a 17

B

S04H4125SP
111.50€
Jogo de chaves de caixa com 25 peças de 1/2"

Composição/ medidas em mm:

- R3704** Roquete de 48 dentes
S04H4 Chaves: 10; 11; 12; 13; 14; 15; 16; 17; 18; 19; 20; 21; 22; 23; 24; 27; 30 e 32
S24H4 Extensões
S17H4 Chaves de velas: 16 e 21
S23H4125 Cabo "T" corrediço
S15H472 Adaptador universal

B

S04H4131SP

144.90€

Jogo de chaves e roquete com 31 peças de 1/2"

Composição/ medidas em mm:

- Roquete de 72 dentes
- Chaves de caixa: 10 a 32
- Chaves de velas: 16 e 21
- Cardan
- Extensão de 125
- Extensão de 250
- Cabo "T" corrediço de 250
- Bits hexagonais de 5; 6; 8; 10 e 12

C



S04H4524SP

122.60€

Jogo de chaves sextavadas com 24 peças de 1/2"

Composição/ medidas em mm:

- R3704 Roquete de 48 dentes
- S04H4 Chaves: 10; 11; 12; 13; 14; 15; 16; 17; 18; 19; 20; 21; 22; 23; 24; 27; 30 e 32
- S24H4 Extensões 5" e 10"
- S15H472 Adaptador universal
- S22H41375 Punho flexível 15"
- S23H41300 Cabo "T" corrediço

B



S04H4726SP

128.10€

Jogo de chaves de caixa com 26 peças de 1/2"

Composição/ medidas em mm:

- R3704 Roquete de 48 dentes
- S04H4 Chaves de caixa: 12; 13; 14; 15; 16; 17; 18; 19; 20; 21; 22; 23; 24; 25; 26; 27; 28; 30 e 34
- S24H4 Extensões 5" e 10"
- S17H4116 Chave de velas 16
- S15H472 Adaptador universal
- S23H41300 Cabo "T" corrediço
- S41H4 Manivela de punho metálico

B



S04H4728SP

124.20€

Jogo de chaves de caixa sextavadas com 28 peças de 1/2"

Composição/ medidas em mm:

- R3704 Roquete de 48 dentes
- S04H4 Chaves de caixa: 8; 9; 10; 11; 12; 13; 14; 15; 16; 17; 18; 19; 20; 21; 22; 23; 24; 25; 26; 27; 28; 30; 32 e 34
- S24H4250 Extensão 10"
- S15H472 Adaptador universal
- S23H41300 Cabo "T" corrediço

B



S06H427SP

102.50€

Jogo de chaves de caixa bits com 27 peças de 1/2" e 3/8"

Composição:

- S09H4 Bits hexagonais de 1/2"
- S49H4 Bits estriados de 1/2"
- S09H3 Bits hexagonais de 3/8"

A



S09H4118SP

78.00€

Jogo de chaves de caixa bits hexagonais com 18 peças de 1/2"

Composição:

- Chaves 55mm: H5; H6; H7; H8; H10; H12; H14; H17 e H19
- Chaves 100mm: H5; H6; H7; H8; H10; H12; H14; H17 e H19

A



S29H4140SP

57.70€

Jogo 40 bits de 3/8" para quadra de 1/2" e 3/8"

Composição:

- Bits hexagonais
- Bits torx
- Bits estriados
- Porta bits

A



V1311SP
163.80€
Jogo de alicates de cravar e descarnar

Composição:

V1310 Alicates de cravar terminais isolados e não isolados

V1401 Alicates de descarnar fios

AG010031A Pesca magnético com espelho

Teste para circuitos

Kit com 60 terminais

B

W23108SP
70.20€
Jogo de 8 chaves de luneta 75°

Composição/ medidas em mm:

W23 Chaves: 6x7; 8x9; 10x11; 12x13; 14x15; 16x17; 18x19 e 20x22

A

W24A109SP
170.50€
Jogo de 9 chaves de luneta aberta flexível

Composição/ medidas em mm:

W24A Chaves: 8x8; 10x10; 11x11; 12x12; 13x13; 14x14; 17x17; 19x19 e 22x22

A

W25110SP
66.90€
Jogo de 10 chaves de bocas

Composição/ medidas em mm:

W25 Chaves: 6x7; 8x9; 10x11; 12x13; 14x15; 16x17; 18x19; 21x23; 24x27 e 30x32

A

W26112SP
67.50€
Jogo de 12 chaves mistas de boca/ luneta

Composição/ medidas em mm:

W26 Chaves: 8; 9; 10; 11; 12; 13; 14; 15; 16; 17; 19 e 22

A

Tabuleiros de ferramenta para carros
W26116SP
86.40€
Jogo de 16 chaves mistas de boca/ luneta

Composição/ medidas em mm:

W26 Chaves: 6; 7; 8; 9; 10; 11; 12; 13; 14; 15; 16; 17; 18; 19; 22 e 24

B

W45112SP
164.90€
Jogo de 12 chaves mistas de boca/ roquete de 72 dentes

Composição/ medidas em mm:

W45 Chaves: 8 a 19

A

W47108SP
89.10€
Jogo de 8 chaves de luneta angular com roquete

Composição/ medidas em mm:

W47 Chaves: 6x7; 8x9; 10x11; 12x13; 14x15; 16x18; 17x19 e 21x22

A

W106115SP
215.00€
Novo
Jogo de 15 chaves de boca/ roquete reversível de 72 dentes

Composição/ medidas em mm:

W60 Chaves: 9 a 19

Adaptadores de 1/4"; 3/8" e 1/2"

Porta bits de 10

B

W70A118S
295.30€
Jogo de chaves em "T" com roquete articulado

Composição/ medidas em mm:

W60 Chave em "T" de 300

Chave em "T" de 50

Chave com roquete de 72 dentes

Extensão de 3"

Extensão de 6"

Adaptador 3/8" (F)x3/8" (F)

B

Tabuleiros em espuma de alta densidade EVA

JA-C131SV

718.70€

Gaveta para serviço em pneus (gaveta completa)

Composição:

- JAI-0924 Pistola pneumática de 1/2"
- JAR-6309A Roquete pneumático de 1/2"
- JAG-0906R Retificadora pneumática de 1/4"
- Chaves de impacto longas de 1/2"
- Chaves de impacto de 1/2"
- Adaptador de 3/8"-1/2"
- Adaptador de 1/2"-3/8"
- Adaptador de 1/2"-3/4"
- Cardan de 1/2"
- Extensões de 1/2"

D



D71157SV

238.90€

Gaveta com chaves de fenda/ phillips, alicates e bits (gaveta completa)

Composição/ medida em mm:

- Chaves de fenda: 6,5x38; 4x80; 5,5x125 e 6,5x150
- Chaves phillips: PH2x38; PH1x80; PH2x100 e PH3x150
- Chaves de fenda/pancada: 6,5x125; 8x150 e 9,5x175
- Chaves phillips/pancada: PH2x100 e PH3x150
- Bits hexagonais: 4; 5; 6; 7; 8; 10 e 12 de 30 e 75mm de comprimento
- Bits torx: T20; T25; T30; T40; T45; T50 e T55 de 30 e 75mm de comprimento
- Bits XZN: M5; M6; M8; M10 e M12 de 30 e 75mm de comprimento
- Porta bits de 3/8" e 1/2"
- Alicates de freios

D



D737128SV

225.10€

Gaveta com chaves de fenda/ phillips (gaveta completa)

Composição:

- D71PP08SP Jogo de chaves de fenda/ phillips
- D70105SP Jogo de chaves de fenda/ phillips pancada
- M645114SP Jogo de serra, chave inglesa, punções e escopros

D



D737134SV

220.60€

Gaveta com chaves de fendas/ phillips (gaveta completa)

Composição:

- D3750P065S Jogo de chaves de precisão
- D3750T08S Jogo de chaves de precisão
- D70105SP Jogo de chaves de fenda/ phillips pancada
- D71PP08SP Jogo de chaves de fenda/ phillips
- W43A106S Jogo de chaves de caixa flexível
- W43A0607 Chave flexível 06x07

D



H10121SV

189.80€

Gaveta com chaves macho hexagonais de punho, talhadeiras e martelos (gaveta completa)

Composição:

- H10MB08S Jogo de chaves duplas hexagonais de punho
- H10MT08S Jogo de chaves duplas torx tamperproof de punho
- AG010026S Jogo de martelos e talhadeiras

D



P82714SV

282.50€

Gaveta com alicates (gaveta completa)

Composição:

- P018SP Jogo de alicates
- P2710SP Jogo de alicates
- AG010002SP Jogo de alicates de freios
- P71 Jogo de mini alicates

D

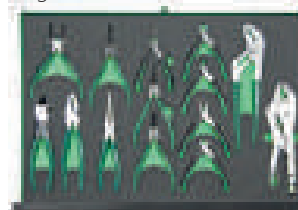

P82736SV

312.00€

Gaveta com alicates e bits de caixa (gaveta completa)

Composição:

S06H427SP Jogo de chaves de caixa bits de 1/2" e 3/8"

AG010002SP Jogo de alicates de freios

P018SP Jogo de alicates

P2710SP Jogo de alicates

D



S04H2184SV

221.70€

Gaveta com 74 peças de 1/4" (gaveta completa)

Composição:

Roquete de 1/4"

Chaves de caixa de 1/4": 4 a 14mm

Bits de caixa hexagonais de 1/4": H2 a H6

Adaptador 3/8"(F) x 1/4" (M)

Adaptador 1/4" (M) x 3/8" (F) para cabo "T" corrediço

Cardan de 1/4"

Extensões de 1/4": 100mm e 150mm

Manivela 1/4": 150mm

Cabo "T" corrediço de 1/4": 130mm

Punho de 1/4" com função fixa/cardan 280mm

Extensão flexível de 1/4": 145mm

Bits phillips, fenda, pozidrive, hexagonais, torx

Chaves de precisão fenda/ phillips

Chaves de fenda/ impacto 9,5x200mm e 9,5x300mm

Chave de fenda 5x150mm

Chave de fenda isolada 1000V 5,5x125mm

D

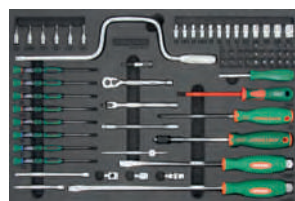

S04H4295SV

295.30€

Gaveta com chaves de caixa e roquete (gaveta completa)

Composição:

S04H2125SP Jogo de chaves de caixa com 25 peças de 1/4"

S04H4131SP Jogo de chaves de caixa com 31 peças de 1/2"

S29H4140SP Jogo de 40 bits de 1/2" e 3/8"

D



S04H3194SV

269.70€

Gaveta com 94 peças de 1/4" e 3/8" (gaveta completa)

Composição:

Roquete de 1/4"

Chaves de caixa de 1/4": 5 a 14mm

Bits de caixa fenda de 1/4": 3,5; 5,5 e 7mm

Bits de caixa hexagonais de 1/4": H3, H4, H5, H6 e H7

Bits de caixa phillips de 1/4": PH1; PH2 e PH3

Bits de caixa torx interior de 1/4": E4; E5; E6; E7 e E8

Bits de caixa torx de 1/4": T10; T15; T20; T25; T30; T35 e T40

Punho de 1/4" com função fixa/ cardan 280mm

Bits torx tamperproof com encaixe de 1/4": T7 a T40

Bits phillips com encaixe de 1/4": PH1; PH2 e PH3

Cabo "T" corrediço de 1/4": 115mm

Extensão de 1/4": 150mm

Cardan de 1/4"

Bits e porta bits de 1/4"

Bit torx tamperproof de 3/8": T55

Roquete de 1/4" de 36 dentes

Adaptador 3/8" x 1/4"

Chaves caixa 3/8": 7 a 22mm

Chaves torx interior 3/8": E10; E12 e E14

Chave torx 3/8": T40

Bits caixa XZN 3/8": M6; M8 e M10

Extensões 3/8": 75mm e 150mm

Roquete e roquete flexível de 3/8" com 36 dentes

Cardan de 3/8"

Adaptador 1/4" (F) x 3/8" (M)

D



S04H42165SV

289.70€

Gaveta com 65 peças de 1/4" e 1/2" (gaveta completa)

Composição:

Roquete de 1/4" de 48 dentes

Chaves de caixa 1/4": 4 a 13mm

Chaves de caixa longas de 1/4": 5 a 13mm

Extensões de 1/4": 50mm e 150mm

Punho de 1/4"

Roquete de 1/2" com 48 dentes

Chaves de caixa 1/2": 10 a 32mm

Chaves de velas 1/2": 16 e 21mm

Extensões de 1/2": 125mm e 250mm

Cabo "T" corrediço

Cardan de 1/2"

Chaves mistas de 6 a 24mm

D



Tabuleiros de ferramenta para carros

Tabuleiros em espuma de alta densidade EVA

S04H46121SV

373.30€

Gaveta com chaves de caixa e roquete (gaveta completa)

Composição:

S04H3157SP Jogo de chaves de caixa com roquete de 1/4" e 3/8"

S04H4125SP Jogo de chaves de caixa com roquete de 1/2"

S29H4140SP Jogo de 40 bits de 1/2" e 3/8"

D



W23559SV

267.40€

Gaveta com chaves de fenda/ phillips/ luneta e alicates (gaveta completa)

Composição:

D71PP08SP Jogo de chaves fenda e phillips

W23108SP Jogo de chaves luneta 75°

P0903SP Jogo de alicates

S29H4140SP Jogo de bits de 1/2" e 3/8"

D



W26134SV

284.10€

Gaveta com chaves de luneta/ mistas/ alicates (gaveta completa)

Composição:

W23108SP Jogo de chaves luneta 75°

P0903SP Jogo de alicates

W26112SP Jogo de chaves mistas (boca/ luneta)

H01SM109S Jogo de chaves hexagonais

P28210 Alicates ajustável

P32M10A Alicates de pressão

D



W2623431SV

254.10€

Gaveta com chaves de luneta e mistas (gaveta completa)

Composição:

W23108SP Jogo de chaves luneta 75°

W24106S Jogo de chaves luneta aberta

W26116SP Jogo de chaves mistas boca / luneta

AI050077 Cinta para filtros óleo

D



W26315SV

424.80€

Tabuleiro com 15 chaves mistas (gaveta completa)

Composição:

W26 20; 21; 23; 25; 26; 27; 28; 29; 30; 32; 36; 38; 41; 46 e 50mm

D



D70105KV

61.30€

Tabuleiro com 5 chaves pancada fenda/ phillips (1/3 de gaveta)

Composição:

D70S6125 Chave fenda 6,5x125mm

D70S8150 Chave fenda 8x150mm

D70S9175 Chave fenda 9,5x175mm

D70P2100 Chave phillips PH2x100mm

D70P3150 Chave phillips PH3x150mm

A



D70PS119KV

91.40€

Tabuleiro com 5 chaves fenda/ phillips e desandador (1/3 de gaveta)

Composição:

3 Chaves phillips pancada: PH1x75; PH2x100 e PH3x125

2 Chaves fenda pancada: 6,5x150 e 9,5x200

1 Desandador de percussão com 13 bits

A



D71PP08KV
51.80€
Tabuleiro com 8 chaves fenda/ phillips (1/3 de gaveta)

Composição:

D71S Jogo de 4 chaves fenda
6,5x38; 4x80; 5,5x125 e 6,5x150mm

D71P Jogo de 4 chaves phillips
PH1X80; PH2X38; PH2x100 e PH3x150mm

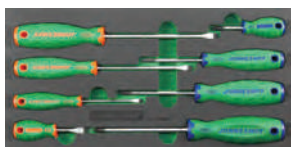
A

H10MB08KV
57.40€
Tabuleiro com 8 chaves hexagonais de punho (1/3 de gaveta)

Composição:

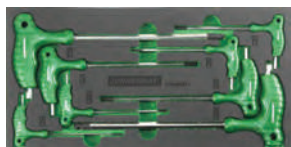
H10MB Jogo de 8 chaves macho
2x100; 2,5x100; 3x100; 4x100; 5x150; 6x150, 8x200
e 10x200mm

A

H10MT08KV
59.10€
Tabuleiro com 8 chaves torx tamperproof de punho (1/3 de gaveta)

Composição:

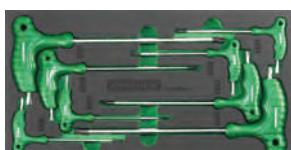
H10MT Jogo de 8 chaves torx
T10x100; T15x100; T20x100; T25x100; T27x150;
T30x150; T45x200 e T50x200mm

A

M09103KV
73.30€
Tabuleiro com martelos e chave inglesa (1/3 de gaveta)

Composição:

M09300 Martelo tipo alemão

M11035 Martelo borracha (anti recuo)

W27AS10 Chave inglesa

A

Tabuleiros de ferramenta para carros

Tabuleiros em espuma de alta densidade EVA
M63113KV
76.90€
Tabuleiro com saca troços, talhadeiras, punções e buril (1/3 de gaveta)

Composição:

6 Saca troços

4 Talhadeiras

1 Buril

1 Punção de bico

1 Punção

A

MHS08KV
81.30€
Tabuleiro com serra e vários (2/3 de gaveta)

Composição:

1 Serra com 2 lâminas extra

1 Fita métrica 3m

1 Régua 330mm

1 X-ato

B

P011804KV
95.40€
Tabuleiro com 4 alicates (1/3 de gaveta)

Composição:

P1118 1 Alicate universal

P0918 1 Alicate de corte diagonal

P0118 1 Alicate de pontas

P2710 1 Alicate ajustável

A

Tabuleiros de ferramenta para carros

Tabuleiros em espuma de alta densidade EVA

P32M105KV

83.70€

Tabuleiro com 5 alicates (1/3 de gaveta)

Composição:

- AG010002 1 Alicata de freios interiores direito
- AG010005 1 Alicata de freios interiores curvo
- AG010008 1 Alicata de freios exteriores direito
- AG010011 1 Alicata de freios exteriores curvo
- P32M10A 1 Alicata de pressão

A



S03A4122KV

122.60€

Tabuleiro com 22 chaves de impacto 1/2" (1/3 de gaveta)

Composição:

- S03A Jogo chaves impacto
10; 11; 12; 13; 14; 16; 17; 19; 21; 22 e 24
- S03AD Jogo chaves impacto longa
10; 11; 12; 13; 14; 16; 17; 19; 21; 22 e 24

A



S04H2132KV

156.00€

Tabuleiro com 32 peças, chaves de bits e extensões (1/3 de gaveta)

Composição:

- S09H3 Chaves caixa bit hexagonais 3/8"
- S09H4 Chaves caixa bit hexagonais 1/2"
- S49H4 Chaves caixa bit estriado 1/2"
- S24H4 Extensões 1/2" - 125 e 250mm
- S17H4 Chaves velas - 16 e 21mm
- S23H4125 Cabo em "t" correção

A



S06H427KV

125.90€

Tabuleiro com 27 bits de caixa (1/3 de gaveta)

Composição:

- S09H3 6x Bits hexagonais de 3/8"
- S09H4 11x Bits hexagonais de 1/2"
- S49H4 10x Bits estriados de 3/8"

A

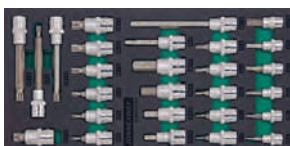

S04H4144KV

158.30€

Tabuleiro com 44 peças, chaves caixa com roquete (1/3 de gaveta)

Composição:

- R3704 Roquete 1/2"
- R3702 Roquete 1/4"
- S04H4 Chaves caixa 1/2"
10; 11; 12; 13; 14; 15; 16; 17; 18; 19; 20; 21; 22; 23; 24;
27; 30 e 32mm
- S04H2 Chaves caixa 1/4"
4; 5; 5,5; 6; 7; 8; 9; 10; 11; 12 e 13mm
- S04HD2 Chaves caixa longa 1/4"
5; 6; 7; 8; 9; 10; 11; 12 e 13mm
- S24H2 Extensões 1/4" - 50 e 150mm
- S26H2150 Punho 1/4"
- S15H472 Cardan 1/4"

A



S07H2138KV

98.10€

Tabuleiro com 18 peças, jogo de bits (1/3 de gaveta)

Composição:

- S06H2 7 Chaves de caixa torx int. 1/4": E4; E5; E6; E7; E8; E10 e E11
- S07H2 11 Bits caixa Torx de 1/4": T6; T7; T8; T9; T10; T15; T20 e T25
- S09H2 5 Bits caixa hexagonais de 1/4": 3, 4, 5 e 6mm
- S10H2 4 Bits caixa fenda 1/4": 3; 4,5; 5,5 e 7mm
- S11H2 4 Bits caixa phillips 1/4": PH0, PH1; PH2 e PH3
- S12H2 4 Bits caixa pozi 1/4": PZ0, PZ1, PZ2 e PZ3
- AG010184C 1 Punho flexível 1/4" com caixa 7mm
- AG010184D 1 Punho flexível 1/4" com caixa 8mm
- 1 Punho flexível de 1/4" com caixa

A



S29H4141KV

101.40€

Tabuleiro com 41 peças, jogo de bits (1/3 de gaveta)

Composição:

- Bits hexagonais
- Bits torx
- Bits estriados
- Porta bits 1/2"
- Porta bits 3/8"
- Chave para molas de travão

A



Tabuleiros de ferramenta para carros
Tabuleiros em espuma de alta densidade EVA
W25106KV
42.30€

Tabuleiro com 6 chaves de bocas (1/3 de gaveta)

Composição:

W25 6x7; 8x9; 10x11; 12x13; 14x15 e 16x17

A

W25107KV
102.50€

Tabuleiro com 7 chaves de bocas (2/3 de gaveta)

Composição:

W25 18-19; 20-22; 21-23; 24-26; 25-28; 27-30 e 30-32mm

B

W25110KV
86.80€

Tabuleiro com 10 chaves de bocas (1/3 de gaveta)

Composição:

W25 6x7; 8x9; 10x11; 12x13; 14x15; 16x17; 18x19; 21x23; 24x27 e 30x32

A

W26108KV
105.90€

Tabuleiro com 8 chaves mistas (2/3 de gaveta)

Composição:

W26 18; 19; 21; 22; 24; 27; 30 e 32mm

B

W26110KV
56.80€

Tabuleiro com 10 chaves mistas (1/3 de gaveta)

Composição:

W26 6; 7; 8; 10; 11; 12; 13; 14; 16 e 17mm

A

W26116KV
92.50€

Tabuleiro com 16 chaves mistas - boca/ luneta (1/3 de gaveta)

Composição:

W26 6; 7; 8; 9; 10; 11; 12; 13; 14; 15; 16; 17; 18; 19; 22 e 24mm

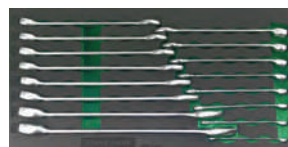
A

W65105KV
48.50€

Tabuleiro com 5 chaves curva luneta (1/3 de gaveta)

Composição:

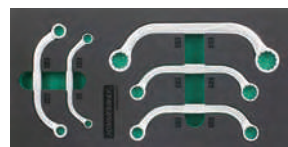
8x10; 10x12; 13x15; 14x17 e 19x22mm

A

AG10002SC

78.10€

Jogo de machos e caçonetes

Composição:

- Machos M3 a M12
- Caçonetes M3 a M12
- Porta caçonetes
- Desandador de machos



D376514SC

49.00€

Jogo de chaves de precisão

Composição:

- Phillips: PH00; PH0 e PH1
- Fenda: 2; 2,4 e 3mm
- Torx: T5; T6; T7; T8; T9; T10; T15 e T20

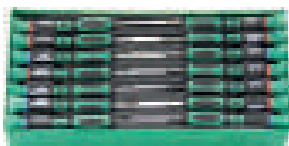

P0813SC

59.60€

Jogo de alicates

Composição:

- P087** Alicate universal
- P097** Alicate de corte
- P118** Alicate de pontas



R4811SC

81.30€

Jogo de chaves de caixa de 1/4" e 3/8"

Composição/ medidas em mm:

- Roquete de 1/4" de 72 dentes
- Roquete de 3/8" de 72 dentes
- Extensão de 3/8": 75
- Extensão de 3/8": 250
- Extensão de 1/4": 50
- Extensão de 1/4": 150
- Cardan de 1/4"
- Cardan de 3/8"
- Adaptador 1/4" - 3/8"
- Adaptador 3/8" - 1/2"
- Punho



S04H5129SC

64.60€

Jogo de chaves de caixa sextavadas de 1/4 e 3/8" com 28 peças

Composição/ medidas em mm:

- Chaves de caixa de 1/4": 4; 4,4; 5; 5,5; 6; 7; 8; 9; 10; 11; 12 e 13
- Chaves de caixa longa: 8; 10; 12 e 13
- Chaves de caixa 3/8": 14; 15; 17; 18; 19; 20; 22 e 24
- Chaves de caixa longa: 14; 15 e 17
- Chaves de velas 3/8": 16 e 21



V11011SC

54.00€

Jogo com alicata de cravar fêmeas

Composição/ medidas em mm:

- Alicata de cravar
- Bicos M3 a M6



W25117SC

72.40€

Jogo de chaves bocas e hexagonais

Composição/ medidas em mm:

- Chaves de bocas: 8x9; 10x11; 12x13; 14x15; 16x17; 18x19; 20x22 e 24x27
- Chaves hexagonais: 1,2; 2; 2,5; 3; 4; 5; 6; 8 e 10



W27AT02SC

64.60€

Jogo de alicates

Composição/ medidas em mm:

- P32M10C** Alicata de pressão
- W27AT10** Chave ajustável



Tabuleiros em espuma EVA aplicáveis aos carros: C-4DW, C-6DW e C-7D

P-EVA(D70105KV)

12.50€



P-EVA(D71PP08KV)

13.00€

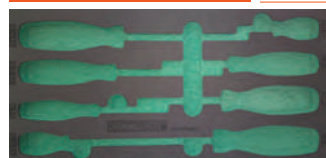

P-EVA(D737128SV)

37.30€



P-EVA(D737134SV)

37.30€

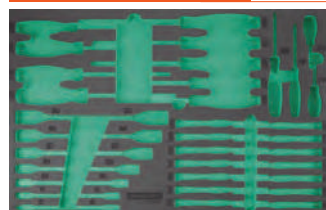

P-EVA(H10MB08KV)

12.60€



P-EVA(H10MT08KV)

12.60€



P-EVA(H10121SV)

37.30€

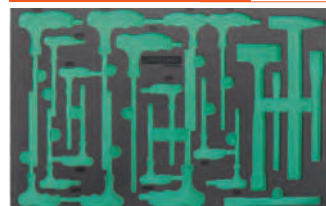

P-EVA(P82736SV)

37.90€



P-EVA(M09103KV)

12.60€



P-EVA(M63113KV)

12.70€



P-EVA(MHS08KV)

23.70€



P-EVA(P011804KV)

12.60€



P-EVA(P32M105KV)

12.60€



P-EVA(P82714SV)

37.30€

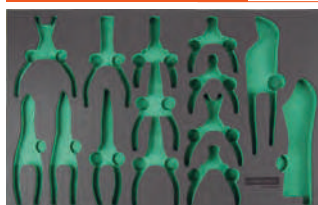

Tabuleiros de ferramenta vazios

Tabuleiros em espuma EVA aplicáveis aos carros: C-4DW, C-6DW e C-7D

P-EVA(S03A4122KV)

12.60€

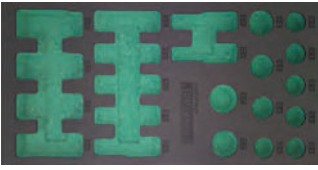

P-EVA(S04H2132KV)

12.60€

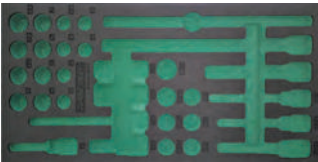

P-EVA(S04H4144KV)

12.60€



P-EVA(S04H4295SV)

36.80€

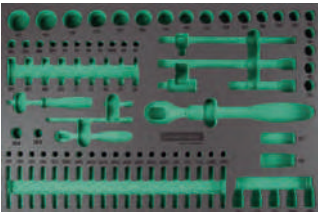

P-EVA(S04H42165SV)

36.80€

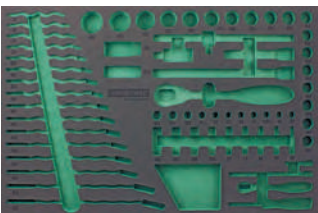

P-EVA(S04H45121SV)

36.80€

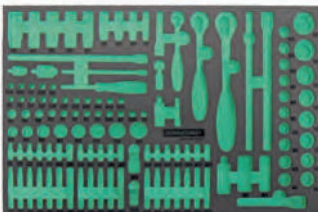

Novo

P-EVA(S07H2138KV)

14.50€



P-EVA(S29H4141KV)

12.60€

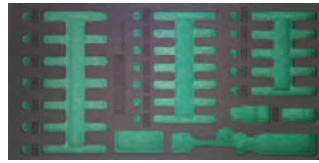

P-EVA(W23559SV)

37.30€

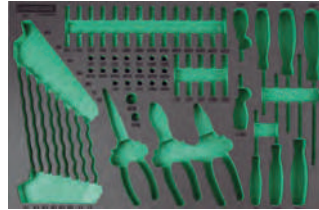

P-EVA(W25110KV)

12.60€

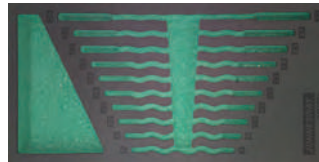

P-EVA(W26116KV)

12.60€

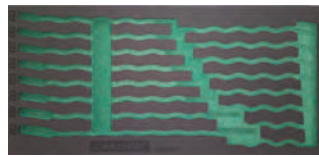

P-EVA(W26134SV)

41.10€



P-EVA(W2623431SV)

36.80€



P-B (31) 7.80€

Medidas:

425x185x52mm

B



P-B (41) 5.70€

Medidas:

375x144,5x52mm

A



Tabuleiros de ferramenta vazios para composições

aplicáveis aos carros: C-4DW, C-6DW e C-7DW

P-TR(AG010002SP)	3.00€
P-TR(AG010026SP)	3.00€
P-TR(AI10002SP)	3.20€
P-TR(D70105SP)	2.70€
P-TR(D71PP08SP)	2.70€
P-TR(H10MB08SP)	3.10€
P-TR(M09513SP)	3.00€
P-TR(M645114SP)	3.00€
P-TR(P018SP)	3.00€
P-TR(P04704SP)	3.00€
P-TR(P0803SP)	3.00€
P-TR(P0903SP)	3.00€
P-TR(P2710SP)	3.00€
P-TR(S03A4122SP)	3.00€
P-TR(S04H2125SP)	2.70€
P-TR(S04H3157SP)	3.70€
P-TR(S04H3536SP)	3.80€
P-TR(S04H4125SP)	3.60€
P-TR(S04H4524SP)	2.70€
P-TR(S04H4726SP)	3.70€
P-TR(S04H4728SP)	3.60€
P-TR(S06H427SP)	2.70€
P-TR(S09H4118SP)	3.00€
P-TR(S29H4140SP)	3.60€
P-TR(W23108SP)	3.00€
P-TR(W25110SP)	2.70€
P-TR(W26112SP)	3.00€
P-TR(W26116SP)	3.00€



Tabuleiros de ferramenta vazios para composições

aplicáveis à mala: C-3DH2

P-TR (D70SP06ST) 1.90€

Para chaves D70



P-TR (PC303ST) 1.90€

Para alicates: P087; P106 e P118



P-TR (S04H4120ST) 2.40€

Para chaves de caixa de 1/2" com roquete



P-TR (S04H4506ST) 2.10€

Para extensões



P-TR (W26107ST) 2.10€

Para chaves mistas W26



P-TR (W26920ST) 1.90€

Para chaves mistas W26 e chaves hexagonais



T10H1210S

367.70€

Jogo de chave dinamométrica com 7 chaves intermutáveis 14x18

Torque: 40-210 Nm



T103

Chave "Pata de Galo" 14x18

Ref.	Medida (mm)	Preço
T31313	13	18.40€
T10314	14	14.00€
T10315	15	14.00€
T10316	16	14.00€
T10317	17	14.40€
T10318	18	14.40€
T10319	19	14.40€
T10321	21	14.40€
T10322	22	14.40€
T31324	24	21.20€
T31332	32	21.20€



T290

Cabeçote para chave dinamométrica de cabeças intermutáveis

Ref.	Quadra	Medida (mm)	Preço
T29002	1/4"	14/18	23.40€
T29014	1/2"	14/18	29.00€
T29016	3/4"	14/18	33.40€



T21

Chave dinamométrica com precisão de: +/- 3%

Ref.	Quadra	Torque (Nm)	Comp. (mm)	Preço
T21025N	1/4"	5-25	320	130.50€
T21050N	3/8"	10-50	390	136.40€
T211000N	1"	200-1 000	1 510	722.50€
T21101N	1/2"	20-100	390	158.90€
T21200N	1/2"	40-200	502	162.00€
T21340N	1/2"	60-340	604	186.90€
T21341N	3/4"	60-340	604	192.10€
T21550N	3/4"	110-550	938	426.90€



T25

Chave dinamométrica com precisão de: +/- 4%

Ref.	Quadra	Torque (Nm)	Comp. (mm)	Preço
T25100N	3/8"	20-100	390	113.60€
T25200N	1/2"	40-200	502	119.80€
T25340N	1/2"	60-340	604	153.50€



T27

Chave dinamométrica com precisão de: +/- 4%

Ref.	Quadra	Torque (Nm)	Comp. (mm)	Preço
T27010N	1/4"	2-10	308	82.00€
T27020N	1/4"	4-20	340	83.10€
T27021N	3/8"	4-20	340	81.30€
T27060N	3/8"	10-60	340	86.90€
T271001N	1"	200-1 000	1 177	596.10€
T27101N	1/2"	20-100	458	93.60€
T27200N	1/2"	40-200	531	103.60€
T27340N	1/2"	60-340	585	113.70€
T27800N	3/4"	150-800	1 177	495.90€



T30200NS

298.00€

Barra dinamométrica com conjunto de 9 ponteiras de bocas - Precisão 4%

Composição:

Torque: 40-200 Nm

Cabeçote 1/2"

Encaixe: 14x18mm

Ponteiras: 13; 14; 15; 17; 19; 22; 24; 27 e 30mm



T33

Chave dinamométrica reversível

Precisão: sentido horário: 5%

sentido anti-horário: 6%

Ref.	Quadra	Torque (Nm)	Preço
T33025N	1/4"	5-25	124.50€
T33050N	3/8"	10-50	138.10€
T33101N	1/2"	20-100	140.50€
T33200N	1/2"	40-200	147.30€
T33341N	3/4"	60-340	183.50€



T41

Chave dinamométrica

Ref.	Quadra	Medida (nm)	Preço
T41200N	1/2"	40-200	175.00€
T41340N	1/2"	60-340	206.10€



Novo

Novo

T41-SK

32.30€

Medidor angular p/T41 e T21
200/340Nm



T14200N

278.60€

Chave dinamométrica digital intermutável com precisão de: +/- 1%

Capacidade: 20-200Nm
Comprimento: 550mm
Peso: 1 150g
Cabeçote: 14x18

Memória: 10 leituras
Unidade: Nm; fb-lb; Kg-m; in-lb
Pilhas: 3x1,5v AA (não incluídas)



T24135

390.00€

Chave dinamométrica digital reversível
com aperto à esquerda e à direita
Precisão de: +/- 2% à direita | +/- 3% à esquerda

Torque: 6,8-135Nm

Quadra: 3/8"



T24200

378.90€

Chave dinamométrica digital com aperto à esquerda e à direita
Precisão de: +/- 2% à direita | +/- 3% à esquerda

Capacidade: 10-200Nm
Comprimento: 530mm
Quadra: 1/2"

Memória: 50 leituras
Unidade: Nm; fb-lb; Kg-cm; in-lb



T19

Medidor digital de torque com precisão de: +/- 2%
Com aviso luminoso e sonoro

Ref.	Quadra	Torque (Nm)	Preço
T19135N	3/8"	10-135	75.80€
T19200N	1/2"	20-200	78.00€



Ferramenta de aperto

T19600N

306.40€

Medidor digital de torque

Quadra: 3/4"
Torque: 60-600 Nm



T

Kits de reparação para chaves dinamométricas

Ref.	Aplicáveis aos modelos	Preço
T04M060-R	T04M060	8.70€
T04M061-R	T04M061	9.20€
T04M150-R	T04M150	11.30€
T04M250-R	T04M250	15.20€
T07030N-R	T07030N	8.30€
T07110N-R	T07110N	9.00€
T07700N-R	T07700N	70.20€
T102001S-R	T102001S	14.50€
T154100N-R	T154100N	11.30€
T154200N-R	T154200N	17.00€
T16005N-R	T16005N	9.50€
T21025N-R	T21025N	12.40€
T21050N-R	T21050N	12.80€
T211000N-R	T211000N	71.30€
T21101N-R	T21101N	16.20€
T21200N-R	T21200N	15.30€
T21340N-R	T21340N	16.30€
T21341N-R	T21341N	50.10€
T21550N-R	T21550N	50.10€
T24135-R	T24135	23.40€
T24200-R	T24200	26.70€
T25100N-R	T25100N	12.80€
T25200N-R	T25200N	13.90€
T25340N-R	T25340N	13.90€
T27-D2R	T27010N, T27020N, T27030N	8.60€
T27-D3R	T27021N, T27031N, T27060N, T27100N	9.10€
T27-D4R1	T27101N	10.80€
T27-D4R2	T27200N, T27340N	12.50€
T27-D6R	T27500N, T27600N, T27800N, T271000N	30.60€
T27-D8R	T27801N, T271001N	51.80€
T33025N-R	T33025N	12.30€
T33050N-R	T33050N	14.50€
T33101N-R	T33101N	15.60€
T33200N-R	T33200N	15.70€
T33341N-R	T33341N	17.30€
T41200N-R	T41200N	11.70€
T41340N-R	T41340N	11.70€



R12

Roquete reversível de 60 dentes

Ref.	Quadra	Comp. (mm)	Preço
R1206N	3/4"	500	75.00€
R12081	1"	675	155.00€



Novo
Novo

R29

Roquete reversível de 36 dentes



Ref.	Quadra	Comp. (mm)	Preço
R2902	1/4"	146	15.00€
R2904	1/2"	278	22.80€

R34

Roquete de 72 dentes com punho antideslizante



Ref.	Quadra	Comp. (mm)	Torque (Nm)	Preço
R3403	3/8"	196	245	24.00€

R35

Roquete de 72 dentes com punho antideslizante



Ref.	Quadra	Comp. (mm)	Torque (Nm)	Preço
R3502	1/4"	135	68	18.90€
R3503	3/8"	199	245	23.40€
R3504	1/2"	250	647	27.90€

R36

Roquete metálico reversível de 48 dentes



Ref.	Quadra	Comp. (mm)	Torque (Nm)	Preço
R3602	1/4"	128	68	19.30€
R3603	3/8"	198	245	19.70€

R37

Roquete reversível de 48 dentes com punho antideslizante



Ref.	Quadra	Comp. (mm)	Torque (Nm)	Preço
R3702	1/4"	135	68	18.60€
R3703	3/8"	198	245	23.40€
R3704	1/2"	353	647	27.60€

R37B

Roquete reversível curto de 48 dentes com punho antideslizante



Ref.	Quadra	Comp. (mm)	Torque (Nm)	Preço
R3702B	1/4"	110	68	18.90€
R3704B	1/2"	180	647	25.10€

R41

Roquete reversível e articulado de 36 dentes com punho antideslizante



Ref.	Quadra	Comp. (mm)	Preço
R4103	3/8"	238	22.80€
R4104	1/2"	288	28.40€

R45

Roquete reversível e rotativo de 48 dentes



Ref.	Quadra	Comp. (mm)	Preço
R4502	1/4"	185	40.50€

R46

Roquete 48 dentes longo



Novo

Ref.	Quadra	Preço
R4602	1/4"	25.50€
R4603	3/8"	29.70€
R4604	1/2"	36.10€

R48

Roquete reversível de 72 dentes



Ref.	Quadra	Comp. (mm)	Preço
R4802	1/4"	146	16.20€
R4803	3/8"	185	18.40€
R4804	1/2"	278	23.80€

R48

Roquete metálico reversível de 72 dentes



Ref.	Quadra	Comp. (mm)	Preço
R4802A	1/4"	125	14.00€
R4804A	1/2"	250	22.30€

R48

Roquete curto reversível de 72 dentes



Ref.	Quadra	Comp. (mm)	Peso (g)	Preço
R4802B	1/4"	110	100	14.50€
R4804B	1/2"	170	442	21.70€

R51

Roquete reversível e extensível de 72 dentes com punho antideslizante

Ref.	Quadra	Comp. (mm)	Peso (g)	Preço
R5103	3/8"	220-230	440	23.40€
R5104	1/2"	300-400	930	29.80€

R66

Roquete com cabo rotativo de 60 dentes

Ref.	Quadra	Comp. (mm)	Peso (g)	Preço
R6602	1/4"	180	181	49.50€
R6603	3/8"	290	645	49.00€
R6604	1/2"	240	384	61.00€

R68

Roquete reversível de baixo perfil de 60 dentes

Ref.	Quadra	Peso (g)	Preço
R6802	1/4"	165	19.20€
R6803	3/8"	265	24.00€
R6804	1/2"	520	27.90€

RD01

Mini roquete

Quadra: 1/4"
Dentes: 60
Comprimento: 200mm

17.00€
RD02

Mini roquete flexível

Quadra: 1/4"
Dentes: 60
Comprimento: 170mm

20.10€
T094602

Roquete desmultiplicador 1/2" - 3/4" R 1:3

Torque máximo: 1 500 Nm

367.70€
T094602-RK

Kit de reparação

310.00€
T096801

Roquete desmultiplicador 3/4" - 1" R 1:4

Torque máximo: 2 500 Nm

384.40€
T096801-RK

Kit de reparação

312.00€
T351060

Aparafusador de torque de 1 a 6Nm

Composição:

Aparafusador: 1-6 Nm
Adaptador 1/4"
4 Bits phillips: PH0; PH1; PH2 e PH3
4 Bits fenda: 3; 4; 5 e 6mm
5 Bits torx: 10; 15; 20; 25 e 30
6 Bits hexagonais: 1.5; 2; 3; 4; 5 e 6mm

161.60€
R

Kits de reparação para roquetes



Ref.	Aplicáveis aos modelos	Preço
R1206N-R	R1206N	29.30€
R1206R	R1206	25.60€
R2902RK	R2902; R2902A; R2902B	6.70€
R2903RK	R2903; R2903A; R2903B; R4103	7.20€
R2904RK	R2904; R2904A; R2904B; R4104	8.10€
R3602RK	R3602; R3702; R3702B; R3802	9.80€
R3603RK	R3603; R3703; R3803	12.60€
R3604RK	R3604; R3704; R3704B; R3804	13.90€
R3402RK	R3402; R3502	9.90€
R3403RK	R3403; R3503	12.70€
R3404RK	R3404; R3504	14.10€
R4502RK	Para cabeça de roquete	9.20€
R4502JRK	Para articulação	8.60€
R4802RK	R4802	6.60€
R4804RK	R4804	8.00€
R5103RK	R5103	7.20€
R5104RK	R5104	10.00€
R5802ERK	R5802E	11.80€
R5803RK	R5803	14.50€
R5804ERK	R5804E	18.40€
R5804LRK	R5804L	18.60€
R6802RK	R68	11.20€
R6803RK	R68	14.20€
R6804RK	R68	15.40€
R12081RK	R12081	78.50€

W24A107S

116.00€

Jogo de chaves luneta aberta flexível

Composição:

Chaves: 8x8; 10x10; 11x11; 12x12; 13x13; 14x14 e 17x17

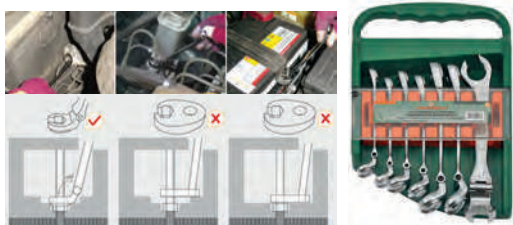

W45

Chave combinada boca/ roquete



Ref.	Medida (mm)	Comp. (mm)	Preço
W45108	8	135,40	9.80€
W45109	9	159,50	11.50€
W45110	10	159,50	11.70€
W45111	11	165,90	11.80€
W45112	12	168,60	11.90€
W45113	13	178,50	12.00€
W45114	14	190,50	12.50€
W45115	15	199,40	13.40€
W45116	16	206,40	14.40€
W45117	17	225,40	15.50€
W45118	18	236,40	16.20€
W45119	19	247,40	17.00€
W45121	21	281,00	24.50€
W45122	22	281,00	26.70€
W45124	24	281,00	27.90€
W45127	27	330,00	47.40€
W45130	30	425,00	51.60€
W45132	32	425,00	56.30€

W45110S

104.70€

Jogo de chaves de boca/ roquete de 9 peças

Composição:

W45 Chaves: 8; 10; 12; 13; 17 e 19mm
Adaptadores 1/4"; 3/8" e 1/2"
Porta bits



W45117S

378.90€

Jogo de chaves combinadas boca/ roquete com 72 dentes de 17 peças

Composição:

W45 Chaves: 8; 10; 12; 13; 14; 17; 19; 21; 22; 24; 27; 30 e 32mm
Adaptadores 1/4"; 3/8" e 1/2"
Porta bits
Mala



W45316S

178.30€

Jogo de chaves combinadas boca/ roquete com 72 dentes de 16 peças

Composição:

W45 Chaves: 8 a 19mm
Adaptadores 1/4"; 3/8" e 1/2"
Porta bits
Mala



W45316S-AD

17.80€

Conjunto de 4 adaptadores

Composição:

Adaptadores 1/4"; 3/8" e 1/2"
Porta bits



W45316S-AD12

6.10€

Adaptador 1/2" para chave 19mm



W45316S-AD14

4.30€

Adaptador 1/4" para chave 10mm



W45316S-AD34

16.70€

Adaptador 3/4" para chave 32mm



W45316S-AD38

5.00€

Adaptador 3/8" para chave 13mm



W45316S-ADBH14

2.00€

Porta bits 1/4" para chave 10mm



W51110S

131.50€

Jogo de 10 chaves curtas boca/ roquete

Composição:

W51 Chaves: 8; 10; 11; 12; 13; 14; 15; 16; 17 e 19mm

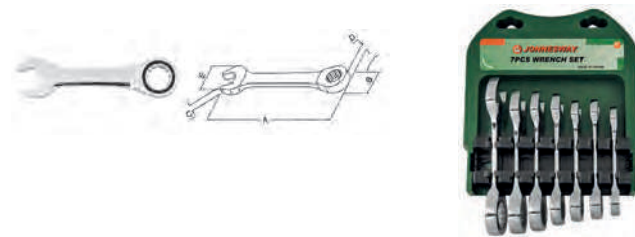

W52105S

100.30€

Jogo de 5 chaves curtas boca/ roquete flexível

Composição:

W52 Chaves: 8; 10; 12; 14 e 17mm



W66107S

131.50€

Jogo de 7 chaves de boca/ roquete flexível

Composição:

W66 Chaves: 8; 10; 11; 13; 14; 17 e 19mm



W66

Chave de boca/ roquete flexível

Ref.	Medida (mm)	Comp. (mm)	Preço
W66108	8	137	16.70€
W66109	9	159	16.70€
W66110	10	159	17.00€
W66111	11	175	17.80€
W66112	12	175	17.80€
W66113	13	186	19.50€
W66114	14	194	20.90€
W66115	15	216	20.90€
W66116	16	216	25.00€
W66117	17	232	23.10€
W66118	18	250	24.00€
W66119	19	250	24.50€
W66121	21	250	35.10€
W66124	24		42.70€



W66116S

256.30€

Jogo de chaves combinadas boca/ roquete flexível de 72 dentes com 16 peças

Composição:

W66 Chaves: 8 a 19mm
Adaptadores 1/4"; 3/8" e 1/2"
Suporte de bit
Mala



W67104S

70.20€

Jogo de chaves luneta (torx) com roquete

Composição:

Chaves: E6xE8; E10xE12;
E14xE18 e E20xE24mm



W68

Chave roquete de 72 dentes

Ref.	Medida (mm)	Preço
W680809	8x9	16.20€
W680810	8x10	16.70€
W681011	10x11	17.60€
W681213	12x13	17.60€
W681415	14x15	20.60€
W681618	16x18	21.20€
W681719	17x19	23.40€



W68106S

105.90€

Jogo de chaves roquete de 72 dentes com 6 peças

Composição:

W68 Chaves: 8x9; 10x11; 12x13;
14x15; 16x18 e 17x19



W73

Chave 4 em 1 com roquete

Ref.	Medida (mm)		Preço
W7310813	8x10	12x13	27.20€
W7311419	14x17	18x19	31.00€



W73102S

52.60€

Jogo de chaves com roquete 4 em 1

Podendo ser utilizadas em 4 medidas

Composição/ medidas em mm:

Chave 8x10 - 12x13
Chave 14x17 - 18x19



W91107S

104.70€

Jogo de chaves combinadas boca especial/ roquete de 72 dentes

Composição:

Chaves: 10; 12; 13; 14; 15; 17 e 19mm



W91

Chave boca especial/ luneta com roquete

Ref.	Medida (mm)	Comp. (mm)	Preço
W91110	10	159,5	11.10€
W91112	12	168,6	12.30€
W91113	13	178,5	12.80€
W91114	14	190,5	13.10€
W91115	15	199,4	15.00€
W91117	17	225,4	16.70€
W91119	19	247,4	17.30€



W93108S

144.90€

Jogo de chaves mistas com roquete reversível e anel de retenção

Composição:

Chaves: 10; 11; 12; 13; 14; 15;
17 e 19mm



W93

Chave mista boca roquete com anel retenção

Ref.	Medida (mm)	Comp. (mm)	Preço
W93110	10	158	14.70€
W93111	11	164	15.40€
W93112	12	167	16.50€
W93113	13	177	16.70€
W93114	14	189,4	18.10€
W93115	15	198	19.30€
W93117	17	224	22.30€
W93119	19	245	25.10€



W61

Chave luneta longa

Ref.	Medida (mm)	Comp. (mm)	Preço
W611011	10x11	295	11.70€
W611214	12x14	330	14.10€
W611315	13x15	370	17.20€
W611618	16x18	405	19.70€
W611719	17x19	405	20.00€
W612224	22x24	435	28.90€



W61106S

125.50€

Jogo de 6 chaves luneta longas

Fornecido em bolsa plástica com divisórias

Composição:

Medida	Comp. (mm)
10x11	235
12x14	330
13x15	370
16x18	405
17x19	405
22x24	435

W62
Chave luneta direita

Ref.	Medida (mm)	Comp. (mm)	Preço
W6210607	6x7	120	4.50€
W6210809	8x9	135	4.90€
W6211011	10x11	150	5.80€
W6211213	12x13	165	6.10€
W6211415	14x15	210	6.80€
W6211617	16x17	210	7.40€
W6211819	18x19	225	7.90€
W6212022	20x22	240	8.90€
W6212427	24x27	270	15.30€
W6212528	25x28	285	15.90€
W6213032	30x32	335	18.40€

W62108S

64.60€

Jogo de 8 chaves luneta direita

Composição:

W62 Chaves: 6x7; 8x9; 10x11; 12x13; 14x15; 16x17; 18x19 e 20x22mm

W23108S

68.80€

Jogo de 8 chaves luneta 75°

Fornecido em bolsa plástica com divisórias

Composição:

W23 Chaves: 6x7; 8x9; 10x11; 12x13; 14x15; 16x17; 18x19 e 20x22mm

W23
Chave luneta 75°

Ref.	Medida (mm)	Comp. (mm)	Preço
W230607	6x7	168	4.50€
W230809	8x9	183	4.80€
W230810	8x10	183	5.50€
W231011	10x11	198	5.60€
W231113	11x13	217	6.30€
W231213	12x13	217	6.70€
W231317	13x17	217	7.80€
W231415	14x15	239	7.80€
W231617	16x17	260	8.50€
W231719	17x19	292	8.80€
W231819	18x19	292	9.40€
W231922	19x22	318	10.60€
W232022	20x22	318	11.90€
W232123	21x23	327	12.80€
W232224	22x24	327	13.50€
W232426	24x26	329	14.90€
W232427	24x27	329	15.10€
W232528	25x28	347	16.00€
W233032	30x32	362	18.20€

W24
Chave luneta aberta

Ref.	Medida (mm)	Faces	Comp. (mm)	Preço
W240809	8x9	6	145	3.80€
W241011	10x11	6	152	4.10€
W241012	10x12	6	152	4.10€
W241213	12x13	6	165	4.80€
W241214	12x14	6	178	4.80€
W241314	13x14	6	178	5.10€
W241417	14x17	6	196	6.40€
W241617	16x17	12	196	7.00€
W241719	17x19	12	210	7.90€
W241819	18x19	12	210	8.00€
W241922	19x22	12	233	10.40€
W242224	22x24	12	252	11.90€
W242427	24x27	12	265	14.70€
W242528	25x28	12	265	15.50€
W243032	30x32	12	285	16.40€

W24N
Chave luneta aberta com batente

Ref.	Medida (mm)	Comp. (mm)	Preço
W24N0810	8x10	122	8.60€
W24N1113	11x13	143	10.00€
W24N1214	12x14	145	10.30€
W24N1719	17x19	162	14.50€

W24106S

41.30€

Jogo de 6 chaves luneta aberta

Fornecido em bolsa plástica com divisórias

Composição:

W24 Chaves: 8x9; 10x11; 10x12; 13x14; 16x17 e 17x19mm



W25

Chave de bocas



Ref.	Medida (mm)	Comp. (mm)	Preço
W250607	6x7	123	2.70€
W250608	6x8	123	2.80€
W250809	8x9	140	3.00€
W251011	10x11	156	3.30€
W251012	10x12	156	3.40€
W251213	12x13	172	3.90€
W251214	12x14	180	3.90€
W251415	14x15	190	4.10€
W251417	14x17	195	5.10€
W251617	16x17	205	5.20€
W251618	16x18	205	6.10€
W251719	17x19	221	6.10€
W251819	18x19	221	6.20€
W251922	19x22	237	7.00€
W252022	20x22	237	7.20€
W252123	21x23	247	8.30€
W252224	22x24	247	8.40€
W252426	24x26	263	9.50€
W252427	24x27	263	9.60€
W252528	25x28	279	11.70€
W252730	27x30	283	12.70€
W252732	27x32	289	13.50€
W253032	30x32	298	13.90€
W253236	32x36	330	25.10€
W253641	36x41	380	31.40€
W253842	38x42	380	33.50€
W254146	41x46	415	48.90€
W254650	46x50	430	68.10€

W25108S

44.80€

Jogo de 8 chaves de bocas

Fornecido em bolsa plástica com divisórias

Composição:

W25 Chaves: 6x7; 8x9; 10x11; 12x13; 14x15; 16x17; 18x19 e 20x22mm



W26

Chave de bocas/ luneta



Ref.	Medida (mm)	Preço
W26106	6	2.50€
W26107	7	2.70€
W26108	8	2.80€
W26109	9	2.70€
W26110	10	3.10€
W26111	11	3.30€
W26112	12	3.40€
W26113	13	3.70€
W26114	14	3.80€
W26115	15	4.50€
W26116	16	4.60€
W26117	17	5.50€
W26118	18	5.70€
W26119	19	6.20€
W26120	20	7.20€
W26121	21	7.80€
W26122	22	7.90€
W26123	23	8.90€
W26124	24	9.00€
W26125	25	9.80€
W26126	26	10.90€
W26127	27	11.10€
W26128	28	11.80€
W26129	29	12.80€
W26130	30	13.60€
W26132	32	14.80€
W26134	34	26.10€
W26136	36	33.00€
W26138	38	42.20€
W26141	41	47.90€
W26142	42	48.50€
W26144	44	64.30€
W26146	46	65.10€
W26148	48	81.50€
W26150	50	85.40€
W26155	55	124.80€
W26160	60	172.70€
W26165	65	228.40€

W26

Jogo de chaves de boca/ luneta

Fornecido em bolsa plástica com divisórias



Ref.	Chaves	Medida (mm)	Preço
W26112S	12xW26	8 a 17; 19 e 22	66.90€
W26114S	14xW26	10 a 14; 16; 17; 19; 21; 22; 24; 27; 30 e 32	111.90€
W26126S	26xW26	6 a 32	206.80€

W26411PRS

74.20€

Jogo de 11 chaves mistas longas

Fornecido em bolsa plástica com divisórias

Composição:

W264 Chaves: 7; 8; 9; 10; 11; 12; 13; 14; 15; 17 e 19mm

W26414S

177.60€

Jogo de 14 chaves mistas boca/ luneta SAE

Fornecido em bolsa plástica com divisórias

Composição:

W26 Chaves: 3/8"; 7/16"; 1/2"; 9/16"; 5/8"; 11/16"; 13/16"; 7/8"; 15/16"; 1"; 1-1/16"; 1-1/8"; 1-1/4"

W29
Chave luneta para parafusos torx

Ref.	Medida	Comp. (mm)	Preço
W290608	E6xE8	112	7.00€
W290711	E7xE11	125	8.50€
W291012	E10xE12	140	8.50€
W291418	E14xE18	180	8.70€
W291622	E16xE22	200	9.00€
W292024	E20xE24	224	9.10€

W39
Chave de bocas de perfil fino

Ref.	Medida (mm)	Comp. (mm)	Preço
W391011	10x11	175	5.80€
W391213	12x13	210	7.20€
W391415	14x15	210	7.20€
W391617	16x17	250	10.60€
W391819	18x19	250	10.90€

W39108SA

83.60€

Jogo de 8 chaves de bocas de perfil fino

Composição:

W39 Chaves: 6x7; 8x9; 10x11; 12x13; 14x15; 16x17; 18x19 e 20x22mm

W69116S

168.20€

Jogo de 16 chaves mistas 75°

Composição:

W69 Chaves: 7; 8; 9; 10; 11; 12; 13; 14; 15; 16; 17; 18; 19; 21; 22 e 24mm

S57
Chaves de cachimbo

Ref.	Medida (mm)	Preço
S57H108	8	10.10€
S57H109	9	10.70€
S57H110	10	11.40€
S57H111	11	12.00€
S57H112	12	14.10€
S57H113	13	17.80€
S57H115	15	18.00€
S57H116	16	18.40€
S57H117	17	21.40€
S57H118	18	21.60€
S57H119	19	21.80€
S57H121	21	29.50€
S57H122	22	37.90€
S57H123	23	37.90€
S57H124	24	41.80€
S57H125	25	42.30€
S57H127	27	54.60€
S57H132	32	71.30€

S57H108S

131.50€

Jogo de 8 chaves de cachimbo

Fornecido em bolsa plástica com divisórias

Composição:

S57 Chaves: 8; 10; 11; 13; 16; 17; 18 e 19mm

W65
Chave curva luneta para motores de arranque

Ref.	Medida (mm)	Preço
W6510810	8x10	4.30€
W6511012	10x12	5.10€
W6511315	13x15	5.70€
W6511417	14x17	6.80€
W6511922	19x22	8.80€



Ferramenta de aperto



W65A

Chave curva luneta



Ref.	Medida	Comp. (mm)	Preço
W65A1012	10x12	141	8.90€
W65A1214	12x14	166	10.30€
W65A1315	13x15	190	14.60€
W65A1618	16x18	220	15.50€
W65A1719	17x19	220	16.50€
W65A1922	19x22	256	20.10€
W65A2224	22x24	245.00€	

W65A105S

75.60€

Jogo de 5 chaves curvas luneta

Composição:

W65A Chaves: 10x12; 12x14; 13x15; 16x18 e 17x19mm



W43A

Chave de caixa flexível



Ref.	Medida (mm)	Comp. (mm)	Preço
W43A0607	6x7	180	6.20€
W43A0809	8x9	180	6.40€
W43A1011	10x11	202	6.90€
W43A1213	12x13	222	8.40€
W43A1415	14x15	245	8.80€
W43A1617	16x17	260	10.60€
W43A1819	18x19	280	13.40€

W43A106S

61.30€

Jogo de 6 chaves de caixa flexíveis

Composição:

W43A Chaves: 8x9; 10x11; 12x13; 14x15; 16x17 e 18x19mm
Mala



W77A

Chave luneta 70° para extensão

Utiliza extensão da série W77H



Ref.	Medida (mm)	Comp. (mm)	Preço
W77A124	24	180	22.50€
W77A127	27	190	26.00€
W77A130	30	200	30.10€
W77A132	32	235	35.30€
W77A136	36	245	42.00€
W77A138	38	245	43.50€
W77A141	41	265	51.30€
W77A146	46	280	60.70€
W77A150	50	290	63.00€
W77A155	55	300	92.50€
W77A160	60	345	121.50€
W77A165	65	355	147.10€

W77H

Extensão para chave W77A

Utilizável em conjunto com as chaves da série W77A

Ref.	Medida (mm)	Utilizar em (mm)	Preço
W77H01	480	24~30	27.90€
W77H02	610	32~41	43.50€
W77H03	760	46~55	75.80€
W77H04	860	60~65	95.80€

WFS46

36.40€

Chave para filtro diferencial

Inclui chave hexagonal de 5mm

Medida: 46mm

Estriado de 12 faces

Aplicação: VW: Bora, Golf IV, Sharan

Skoda: Octavia



W67

Chave de boca pancada



Ref.	Medida (mm)	Comp. (mm)	Preço
W67119	19	177	6.70€
W67121	21	177	6.70€
W67124	24	197	8.00€
W67130	30	243	12.80€
W67132	32	273	16.20€
W67136	36	299	25.60€
W67138	38	299	27.30€
W67141	41	339	34.50€
W67145	45	374	39.60€
W67146	46	374	42.00€
W67150	50	417	57.80€
W67155	55	496	80.70€
W67160	60	496	81.10€
W67165	65	496	81.30€
W67170	70	496	145.10€

W72

Chave de luneta pancada



Ref.	Medida (mm)	Comp. (mm)	Preço
W72117	17	160	10.10€
W72118	18	160	10.10€
W72119	19	160	10.30€
W72121	21	160	10.40€
W72122	22	163	10.90€
W72124	24	163	11.00€
W72127	27	180	12.30€
W72130	30	190	16.80€
W72132	32	190	16.90€
W72134	34	205	23.10€
W72136	36	205	23.70€
W72141	41	230	32.10€
W72146	46	240	37.30€
W72150	50	255	51.30€
W72155	55	360	69.10€
W72170	70	335	168.30€

W27AL

Chave inglesa

Maior capacidade de abertura, mais fina e mais leve



Ref.	Medida (mm)	Abertura (mm)	Peso (mm)	Comprimento (mm)	Preço
W27AL10	250	43	277	256	35.00€

W27AR

Chave inglesa



Ref.	Abertura (mm)	Comp. (mm)	Preço
W27AR8	26,9	200	31.80€
W27AR10	34	250	40.10€



ON: funciona como roquete

OFF: funciona como chave inglesa

W27AS

Chave inglesa



Ref.	Abertura (mm)	Comp. (mm)	Preço
W27AS8	20	150	17.30€
W27AS10	29	250	20.60€
W27AS15	43	380	54.60€
W27AS18	53	450	90.30€

W27AT

Chave ajustável com cabo antideslizante



Ref.	Medida (mm)	Comp. (mm)	Preço
W27AT8	24	200	24.50€
W27AT10	29	250	30.50€
W27AT12	34	300	34.50€
W27AT15	43	375	66.90€

W27AK8

37.30€

Chave inglesa duplo sistema (métrico/SAE)

Comprimento: 200mm



Ferramenta SUPERTECH

W28HD

Chave bico de falcão para tubos

Ref.	Abertura (mm)	Comp. (mm)	Preço
W28HD8	10-22	200	34.80€

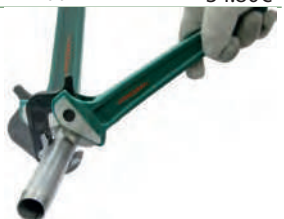

W28

Chave para tubos

Ref.	Abertura (mm)	Comp. (mm)	Preço
W2808	25,5	200	19.50€
W2810	38	250	21.70€
W2812	51	300	28.40€
W2814	51	350	35.10€
W2818	63,5	450	50.10€
W2824	76	600	87.40€
W2836	127	900	183.90€



W28RJ-HL

Garras de substituição

Ref.	Aplicável modelo	Preço
W2810RJ-HL	W2810	6.80€
W2812RJ-HL	W2812	8.10€
W2814RJ-HL	W2814	8.90€
W2818RJ-HL	W2818	12.00€
W2824RJ-HL	W2824	18.60€
W2836RJ-HL	W2836	39.00€



S68H2141S

69.90€

Jogo de 41 peças de 1/4" SUPERTECH

Composição/ medidas em mm:

R2902 Roquete de 36 dentes
 Chaves caixa: 4; 4,5; 5; 5,5; 6; 7; 8; 9; 10; 11; 12; 13 e 14
 Chaves hexagonais: 1,5; 2 e 2,5
 20 Bits
 Extensão de 50
 Cabo "T" corrediço
 Adaptador hexagonal
 Punho



S68H4127S

147.10€

Jogo de 27 peças de 1/2" SUPERTECH

Composição/ medidas em mm:

R2904 Roquete de 36 dentes
 Chaves caixa: 8 a 24; 27; 30 e 32
 Chaves de velas: 16 e 21
 Cardan
 Extensão de 125 e 250
 Cabo "T" corrediço



S68H

Chave de caixa 1/4" SUPERTECH

Ref.	Medida (mm)	SAE	Torx	Preço
S68H2103	3	1/8"	E4	0.90€
S68H2104	4	5/32"	E5	0.90€
S68H21045	4,5			0.90€
S68H2105	5	3/16"	E6	0.90€
S68H21055	5,5	7/32"	E7	0.90€
S68H2106	6		E8	1.00€
S68H21065	6,5	1/4"	E8	1.00€
S68H2107	7	9/32"		1.00€
S68H2108	8	5/16"	E10	1.10€
S68H2109	9	11/32"	E11	1.10€
S68H2110	10	3/8"	E12	1.10€
S68H2111	11	7/16"	E14	1.10€
S68H2112	12	15/32"		1.20€
S68H2113	13	1/2"	E16	1.20€
S68H2114	14	9/16"	E18	1.40€



S68H5234111S
378.90€
Jogo de 111 peças de 1/4", 3/8" e 1/2" SUPERTECH

Composição/ medidas em mm:

- R3702 Roquete de 1/4"
- R3703 Roquete de 3/8"
- R3704 Roquete de 1/2"
- Chaves caixa de 1/4": 3,2 a 13
- Chaves caixa de 3/8": 9 a 19
- Chaves caixa de 1/2": 14 a 32
- Chaves de velas de 3/8": 14 e 18
- Chaves de velas de 1/2": 16 e 21
- Chaves hexagonais: 1,5; 2 e 2,5
- Chaves mistas boca/ luneta: 8 a 19
- Bits de 1/4" fenda/ phillips/ torx/ hexagonal/pozi
- Bits de 5/16" fenda/ phillips/ torx/ hexagonal/pozi
- Adaptador bits 5/16"
- Cardan de 1/4"; 3/8" e 1/2"
- Extensões de 1/4" com 50 e 150
- Extensões de 3/8" com 75 e 150
- Extensões de 1/2" com 125 e 250
- Adaptador "T" para extensões
- Punho

W84108S
75.50€
Jogo de 8 chaves mistas boca/ luneta SUPERTECH

Chaves: 8; 10; 11; 12; 13; 14; 17 e 19mm

W84114S
120.40€
Jogo de 14 chaves mistas boca/ luneta SUPERTECH

Chaves: 6 a 19mm

W84
Chave mista boca/ luneta SUPERTECH

Ref.	Medida (mm)	Preço
W84106	6	4.60€
W84107	7	4.70€
W84108	8	4.80€
W84109	9	5.00€
W84110	10	5.30€
W84111	11	5.70€
W84112	12	6.10€
W84113	13	6.60€
W84114	14	7.00€
W84115	15	7.90€
W84116	16	8.50€
W84117	17	9.40€
W84118	18	10.00€
W84119	19	11.00€

W86112S
271.00€
Jogo de 12 chaves boca/ roquete SUPERTECH

Chaves: 8 a 19mm



S03H2327S

76.50€

Jogo de chaves e bits de caixa de 1/4" com 27 peças

Composição/ medidas em mm:

- Chave mista boca/roquete
- Mini chaves 13mm: 4; 4,5; 5; 5,5; 6; 7; 8; 9; 10; 11; 12; 13 e 14
- Bits caixa hexagonais: 3; 4; 5 e 6mm
- Bits caixa phillips: PH1; PH2 e PH3
- Bits caixa fenda: 5,5 e 7mm
- Cardan
- Extensão 50mm
- Cabo "T" corrediço 115mm



Novo

S03H2353S

134.30€

Jogo 54 chaves 1/4"

Composição/ medidas em mm:

- Roquete longo de baixo perfil
- 13 Chaves de caixa 1/4" 6 faces extra curtas 4 -14mm
- 2 Extensões de 1/4" 50 e 100mm
- Adaptador magnético para bits de 1/4"
- Ponta porta bits magnético 1/4"
- 4 Bits fenda 3; 4; 5,5; 7 mm
- 4 Bits philips PH0; PH1; PH2; PH3
- 3 Bits pozi PZ1; PZ2; PZ3
- 8 Bits torx T8; 10; 15; 20; 25; 27; 30; 40
- 8 Bits torx tamperproof T8; 10; 15; 20; 25; 27; 30; 40
- 5 Bits HEX 2; 3; 4; 5; 6mm
- Cardan 1/4"
- Adaptador para bits de 1/4"

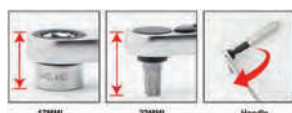

S04H2118S

44.60€

Jogo de chaves de caixa de 1/4" com 18 peças

Composição/ medidas em mm:

- R2902 Roquete de 36 dentes
- S04H2 Chaves caixa: 4; 4,5; 5; 5,5; 6; 7; 8; 9; 10; 11; 12 e 13
- S24H2 Extensões de 2" e 4"
- S23H2 Cabo "T" corrediço
- S15H240 Adaptador universal
- S22H2130 Punho flexível



S04H2141S

79.10€

Jogo de chaves de caixa de 1/4" com 41 peças

Composição/ medidas em mm:

- R3702 Roquete de 48 dentes
- S04H2 Chaves caixa: 4; 5; 5,5; 6; 7; 8; 10; 11; 12 e 13
- S04HD2 Chaves longas de caixa: 7; 8 e 10
- Chaves macho hexagonais: 1,5; 2; 2,5 e 3
- S09H2 Bits hexagonais: 3; 4; 5 e 6
- S07H2 Bits torx: T10; T20; T25; T27; T30 e T40
- S10H2 Bits fenda: 0,8x4; 10x5,5 e 1,2x7
- S11H2 Bits phillips: PH1; PH2 e PH3
- S24H Extensões de 2" e 6"
- S28H1 Punho
- S15H240 Adaptador universal
- S27H2150 Extensão flexível 6"
- S16H3814 Adaptador 3/8 (F) x 1/4" (M)
- Caixa metálica



S04H3125S

86.00€

Jogo de chaves de caixa de 3/8" com 25 peças

Composição/ medidas em mm:

- R3703 Roquete de 48 dentes
- Chaves caixa: 6 a 22
- Chaves de velas: 16 e 21
- S24H Extensões de 75 e 150
- S23H31200 Cabo "T" corrediço de 200
- S15H356 Cardan
- Caixa metálica



S04H3141S

126.50€

Jogo de chaves de caixa de 3/8" com 40 peças

Composição/ medidas em mm:

- R3703 Roquete de 48 dentes
- S04H3 Chaves caixa: 6 a 24
- Chaves de caixa longas: 14; 15; 17 e 19
- Bits torx: T10; T20; T25; T27; T30; T40; T45 e T50
- Bits fenda: 0,8x4; 1x5,5 e 1,2x8
- Bits phillips: PH1; PH2 e PH3
- 2 Extensões
- Cardan
- Adaptador universal
- Mala de transporte



S04H3157S
151.40€
Jogo de chaves de caixa de 1/4" e 3/8" com 56 peças

Composição/ medidas em mm:

- R3702 Roquete 1/4" de 48 dentes
- R3703 Roquete 3/8" de 48 dentes
- S04H2 Chaves de 1/4": 4; 4,5; 5; 5,5; 6; 7; 8; 9; 10; 11; 12 e 13
- S04HD2 Chaves longas de 1/4": 8; 10; 12; e 13
- S04H3 Chaves de 3/8": 14; 15; 17; 18; 19; 20; 22 e 24
- S04HD3 Chaves longas 3/8": 14; 15; 17
- S17H3 Chaves velas 3/8": 16 e 21
- S09H2 Bits hexagonais: 3; 4; 5 e 6
- S07H2 Bits torx: T10; T15; T20; T25; T27 e T30
- S10H2 Bits fenda: 4; 5,5 e 7
- S11H2 Bits phillips: PH1; PH2 e PH3
- S24H2 2 Extensões 1/4" (50mm + 150mm)
- S24H3 2 Extensões 3/8" (75mm + 250mm)
- S16H302 Adaptador de extensão 1/4" - 3/8"
- S16H403 Adaptador de extensão 1/2" - 3/8"
- S15H356 Adaptador universal 3/8"
- S15H240 Adaptador universal 1/4"
- S26H2150 Punho

S04H3536S
133.90€
Jogo de chaves de caixa de 3/8" com 36 peças

Composição/ medidas em mm:

- R3503 Roquete de 72 dentes
- Chaves caixa: 6 a 22mm
- Chaves mistas: 7 a 17mm
- Chaves de velas: 16 e 21mm
- Extensões de 75; 150 e 225mm
- Cardan
- S16H403 Adaptador
- Caixa metálica

S04H4125S
124.80€
Jogo de chaves de caixa de 1/2" com 25 peças

Composição/ medidas em mm:

- R3704 Roquete de 48 dentes
- S04H4 Chaves caixa: 10 a 24; 27; 30 e 32
- Chaves de velas: 16 e 21
- Extensões de 5" e 10"
- Cabo "T" corrediço
- Adaptador universal
- Mala de transporte

S04H4524S
135.80€
Jogo de chaves de caixa de 1/2" com 24 peças

Composição/ medidas em mm:

- R3704 Roquete de 48 dentes
- S04H4 Chaves caixa: 10 a 24; 27; 30 e 32
- S24H4 Extensões de 5" e 10"
- S23H41300 Cabo "T" corrediço
- S15H472 Adaptador universal
- S22H41375 Punho flexível 15"
- Caixa metálica

S04H4728S
139.30€
Jogo de chaves de caixa sextavadas de 1/2" com 28 peças

Composição/ medidas em mm:

- R3704 Roquete de 48 dentes
- S04H4 Chaves caixa: 8 a 28; 30; 32 e 34
- S24H4250 Extensão 10"
- S23H41300 Cabo "T" corrediço
- S15H472 Adaptador universal
- Caixa metálica

S04H6115S
239.60€
Jogo de chaves de caixa de 3/4" com 14 peças

Composição/ medidas em mm:

- Roquete
- Chaves caixa: 22; 24; 27; 30; 32; 36; 38; 41; 46 e 50
- Extensão de 100 e 200
- Cabo "T" corrediço

S04H6321S
373.30€
Jogo de chaves de caixa de 3/4" com 20 peças

Composição/ medidas em mm:

- R1206N Roquete reversível de 500
- S04H61 Chaves caixa: 19; 21; 22; 24; 27; 30; 32; 36; 38; 41; 46 e 50
- S24H6 Extensão de 100; 200 e 400
- S22H6475 Cabo articulado 475
- S16H3412 Adaptador 3/4"F para 1/2"M
- S16H3410 Adaptador 3/4"F para 1"M
- S15H6109 Adaptador universal
- Mala de transporte



S04H8115S

680.00€

Jogo de chaves de caixa de 1" com 14 peças

Composição/ medidas em mm:

- Roquete
- Chaves caixa: 36; 41; 46; 50; 55; 60; 65; 70; 75 e 80
- Extensão de 200 e 400
- Cabo de 550



S06H425S

59.10€

Jogo de 25 bits torx de 1/2" e 1/4"

Composição/ medidas em mm:

- S07H2** Bits torx de 1/4": T8; T10; T15; T20; T25; T27 e T30x32
- S07H3** Bits torx de 1/2": T40; T45; T50; T55 e T60x55
- S06H2** Chaves parafusos torx 1/4": E4; E5; E6; E7 e E8
- S06H4** Chaves parafusos torx 1/2": E10; E11; E12; E14 e E18
- H08** Chaves macho torx: T6; T8 e T10



S06H4127S

119.20€

Jogo de 27 bits de 1/2" e 3/8"

Composição/ medidas em mm:

- S09H4** Bits hexagonais de 1/2": 4; 5; 6; 7; 8; 10 e 12x55; 14x60; 17x70; 8x80 e 10x140
- S49H4** Bits estriados de 1/2": M5; M6; M8; M10; M12; M14; M16x55; M10; M12x110 e M8x120
- S09H3** Bits hexagonais de 3/8": 4; 5; 6; 7; 8 e 10x48



S07H4109S

36.50€

Jogo de 9 chaves bits torx de 1/2"

Composição:

- T20; T25; T27; T30; T40; T50; T55 e T60



S09H4109S

36.80€

Jogo de 9 chaves bits hexagonais de 1/2"

Composição:

- H3; H4; H5; H6; H7; H8; H10; H12 e H14



S07H4932S

152.50€

Jogo de 32 chaves bits torx de 1/2"

Composição:

- Bits 55mm: T20; T25; T27; T30; T40; T45; T50; T55; T60 e T70
- Bits 100mm: T20; T25; T27; T30; T40; T45; T50; T55; T60 e T70
- Bits 140mm: T40; T45; T50; T55; T60 e T70
- Bits 200mm: T40; T45; T50; T55; T60 e T70
- Mala de transporte



S63H4132S

154.80€

Jogo de 32 chaves bits de 6 caneluras (Ribe) 1/2"

Composição:

- Bits 55mm: M5; M6; M7; M8; M9; M10; M12; M13 e M14
- Bits 100mm: M5; M6; M7; M8; M9; M10; M12; M13 e M16
- Bits 140mm: M8; M9; M10; M12; M13 e M14
- Bits 200mm: M8; M9; M10; M12; M13 e M14
- Mala de transporte



S64H4126S

128.10€

Jogo de 26 chaves bits XZN 1/2"

Composição:

- Bits 55mm: M5; M6; M8; M10; M12; M14 e M16
- Bits 100mm: M5; M6; M8; M10; M12 e M14
- Bits 140mm: M5; M6; M8; M10; M12 e M14
- Bits 200mm: M8; M10; M12 e M14
- Mala de transporte



S04H52477S
242.20€
Jogo de 77 peças de ferramenta de 1/2" e 1/4"

Composição/ medidas em mm:

R2904	Roquete 1/2" reversível de 36 dentes
R2902	Roquete 1/4" reversível de 36 dentes
S04H4	Chaves caixa 1/2": 12 a 32
S04H21	Chaves caixa 1/4": 4 a 12
S04HD21	Chaves de caixa longas 1/4": 8; 10; 12 e 13
S17H	Chaves de velas 1/2": 16 e 21 mm
W26	Chaves boca/ luneta: 8; 10; 12; 13; 14; 15; 17 e 19
D04	Jogo de chaves fenda
S24H	Extensões 1/2" de 125 e 250
S24H275	Extensão 1/4" com 75
S15H472	Adaptador universal 1/2"
S15H240	Adaptador universal 1/4"
S16H304	Adaptador 3/8"F para 1/2"M
S23H21130	Cabo "T" correção 1/4"
P2810	Alicate ajustável
P088	Alicate universal
	Pontas de 1/4"
M09500	Martelo de mecânico tipo "Alemão" 500g
	Mala de transporte

S04H52460S
182.70€
Jogo de 60 peças de ferramenta de 1/2" e 1/4"

Composição/ medidas em mm:

	Roquete 1/2" de 36 dentes
	Chaves caixa 1/2": 12; 13; 14; 15; 17; 18; 19; 22 e 24
	Chaves caixa 1/4": 6; 8; 9; 10; 11; 12 e 13
	Chaves de velas 1/2": 16 e 21
	Chaves mistas: 8; 10; 12; 13; 14 e 17
	Jogo de chaves fenda/ phillips
	Bits de 1/4": fenda, torx e phillips
	Porta bits de 1/4"
	Extensões 1/2" de 125 e 250
	Extensão 1/4" com 75
	Extensão flexível de 1/4"
	Adaptador 3/8"F para 1/2"M
	Cabo "T" correção 1/4"
	Alicate ajustável
	Alicate universal
	Pontas de 1/4"
	Martelo
	Cardan de 1/2"
	Punho de 1/4"

S04H52478S
298.60€
Jogo de 78 peças de ferramenta de 1/2" e 1/4"

Composição/ medidas em mm:

	Roquete 1/2" de 48 dentes
	Roquete 1/4" de 48 dentes
	Chaves caixa 1/4": 5 a 11
	Chaves caixa longas 1/4": 5 a 12
	Chaves de velas 1/2": 16 e 21
	Chaves caixa 1/2": 12 a 19; 22; 24; 27 e 32
	Chaves mistas: 6 a 17; 19, 21; 22 e 24
	Chaves allen hexagonais: 2,5 a 10
	Chaves allen torx: T10; T15; T20; T25; T27; T30 e T40
	Chaves luneta aberta: 8x10; 11x13; 12x14 e 17x19
	Jogo de chaves fenda/ phillips
	Extensões 1/2" de 125 e 250
	Extensão 1/4" com 50
	Adaptador 3/8"F para 1/2"M
	Cabo "T" correção 1/4"
	Alicate de pressão
	Cardan de 1/2" e 1/4"
	Punho de 1/4"

S04H624101S
330.80€
Jogo de 101 peças de ferramenta de 1/2" e 1/4"

Composição/ medidas em mm:

R2904	Roquete 1/2" reversível de 36 dentes
R2902	Roquete 1/4" reversível de 36 dentes
S04H4	Chaves caixa sextavadas 1/2": 8 a 24; 27; 30 e 32
S04H2	Chaves caixa sextavadas 1/4": 4; 4,5; 5; 5,5; 6; 7; 8; 9 e 10
S17H4	Chaves de velas 1/2": 16 e 21
S06H4	Chaves caixa torx 1/2": E11; E12; E14; E16 e E18
W24	Chaves luneta aberta: 8x10; 11x13; 12x14 e 17x19
W26	Chaves boca/ luneta: 8; 10 a 19; 21; 22 e 24
D04	Jogo de chaves fenda
S24H4	Extensões 1/2" de 125 e 250
S21H4	Extensão 1/2" de 50
S24H2	Extensões 1/4" de 75 e 100
S27H4	Extensão flexível 1/4"
S14H4	Adaptador universal 1/2"
S15H2	Adaptador universal 1/4"
S23H2	Cabo "T" correção 1/4"
S23H4	Cabo "T" correção 1/2"
W27AS8	Alicate ajustável
P087	Alicate universal
AG010034	Caneta magnética
	Pontas de 1/4"
	Pontas XZN - M6; M8; M10 e M12
	Mala de transporte



S04H524127S

506.20€

Jogo de 127 peças de ferramenta de 1/2" e 1/4"

Composição/ medidas em mm:

- R2904 Roquete 1/2" reversível de 36 dentes
- R2902 Roquete 1/4" reversível de 36 dentes
- Chaves caixa 1/2": 8 a 11; 13 a 19; 21; 22; 24; 27; 30 e 32
- Chaves caixa 1/4": 4; 4,5; 5; 5,5; 6 a 13
- Chaves caixa longa 1/2": 10; 12; 13; 14; 15; 17 e 19
- Chaves caixa longa 1/4": 7; 8; 10; 12 e 13
- Chaves de velas 1/2": 16 e 21
- Chaves caixa torx 1/4": E4; E5; E6; E7 e E8
- Chaves torx 1/2": E10; E12; E14; E16; E18; E20; E22 e E24
- Chaves mistas: 6 a 17; 19; 21; 22; 24; 27; 30 e 32
- Chaves luneta aberta: 8x10; 9x11; 12x13; 14x17 e 17x19
- Chaves hexagonais curtas: 1,5; 2; 2,5; 3; 4; 5; 6; 8 e 10
- Chaves torx: T10; T15; T20; T25; T27; T30 e T40
- Chaves fendas com punho antideslizante
- Chaves phillips com punho antideslizante
- Jogo de punções e escopros
- S21H Extensões 1/4" de 50x150 e de 1/2" 50mm
- S24H Extensões 1/2" de 125 e 250 e de 1/4" de 75
- Extensão flexível 1/4" de 145
- Cabo "T" corrediço 1/4" de 130 e 1/2" de 250
- Cabo articulado 1/2" de 375
- P2810 Alicates ajustável
- P8606 Alicates de corte
- P8007 Alicates universal
- AG010034 Caneta magnética
- M09500 Martelo de mecânico tipo "Alemão" 500g
- Cardan de 1/2" e 1/4"
- Mala de transporte



S04H21

Chave de caixa sextavada 1/4"

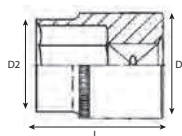

Ref.	Medida (mm)	D1 (mm)	D2 (mm)	L (mm)	Preço
S04H2104	4	11,8	6,8	25	0.90€
S04H21045	4,5	11,8	7,3	25	0.90€
S04H2105	5	11,8	8	25	0.90€
S04H21055	5,5	11,8	8,6	25	0.90€
S04H2106	6	11,8	9,2	25	0.90€
S04H2107	7	11,8	10,5	25	0.90€
S04H2108	8	11,4	11,7	25	1.00€
S04H2109	9	11,6	12,7	25	1.10€
S04H2110	10	12,8	13,7	25	1.10€
S04H2111	11	14,4	15,7	25	1.10€
S04H2112	12	13,7	16,6	25	1.10€
S04H2113	13	13,9	17,6	25	1.20€
S04H2114	14	17,5	20	25	1.30€

S04HD21

Chave de caixa sextavada longa 1/4"

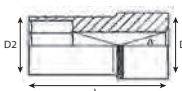

Ref.	Medida (mm)	D1 (mm)	D2 (mm)	L (mm)	Preço
S04HD2105	5	11,8	8,1	50	1.60€
S04HD2106	6	12	9,2	50	1.60€
S04HD2107	7	12	10,5	50	1.60€
S04HD2108	8	11,5	12	50	1.60€
S04HD2109	9	11,3	13,2	50	1.70€
S04HD2110	10	13,3	14,4	50	1.70€
S04HD2111	11	14,8	15,9	50	1.80€
S04HD2112	12	15,8	17	50	1.90€
S04HD2113	13	16,8	17,8	50	2.00€

S04H31

Chave de caixa sextavada 3/8"

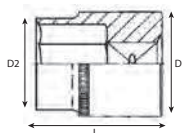

Ref.	Medida (mm)	D1 (mm)	D2 (mm)	L (mm)	Preço
S04H3106	6	16,8	9,6	28	1.20€
S04H3107	7	16,8	10,7	28	1.20€
S04H3108	8	16,8	12	28	1.20€
S04H3109	9	16,8	13,3	28	1.30€
S04H3110	10	16,8	14,4	28	1.30€
S04H3111	11	16,8	15,8	28	1.30€
S04H3112	12	16	16,8	28	1.30€
S04H3113	13	18	19	28	1.30€
S04H3114	14	18,8	19,7	28	1.30€
S04H3115	15	19,8	20,8	28	1.30€
S04H3116	16	20,8	22	28	1.40€
S04H3117	17	22	23,8	28	1.60€
S04H3118	18	24,1	25,7	28	1.70€
S04H3119	19	24,1	25,7	28	1.80€
S04H3120	20	25	27,6	32	2.00€
S04H3121	21	25	27,6	32	2.20€
S04H3122	22	27,8	29,6	32	2.20€
S04H3124	24	29,8	31	32	2.40€



S04HD31

Chave de caixa sextavada longa 3/8"

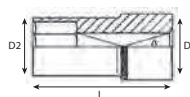

Ref.	Medida (mm)	D1 (mm)	D2 (mm)	L (mm)	Preço
S04HD3109	9	16,8	13,3	63	2.30€
S04HD3110	10	17	14,4	63	2.30€
S04HD3111	11	17	15,8	63	2.50€
S04HD3112	12	17	17,7	63	2.60€
S04HD3113	13	18	19	63	2.60€
S04HD3114	14	18,8	19,7	63	2.60€
S04HD3115	15	19,8	20,8	63	2.80€
S04HD3116	16	20,8	22	63	2.80€
S04HD3117	17	22,8	23,8	63	3.00€
S04HD3119	19	23,8	26	63	3.20€
S04HD3120	20	24,8	27,8	63	3.60€
S04HD3121	21	25,8	28	63	3.60€
S04HD3124	24	28	24	63	4.00€



S04H41

Chave de caixa sextavada 1/2"

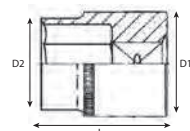

Ref.	Medida (mm)	D1 (mm)	D2 (mm)	L (mm)	Preço
S04H4108	8	21,8	13,8	38	1.70€
S04H4109	9	21,8	14,3	38	1.70€
S04H4110	10	21,8	15,4	38	1.70€
S04H4111	11	21,8	16,7	38	1.70€
S04H4112	12	21,8	18	38	1.70€
S04H4113	13	21,8	19	38	1.70€
S04H4114	14	22	20,3	38	1.70€
S04H4115	15	22	21,3	38	1.70€
S04H4116	16	22	23,3	38	1.80€
S04H4117	17	23	23,8	38	1.90€
S04H4118	18	23,5	24,8	38	2.10€
S04H4119	19	24	27	38	2.10€
S04H4120	20	24	28	38	2.40€
S04H4121	21	24	29	38	2.50€
S04H4122	22	28	30	38	2.80€
S04H4123	23	28	30,7	38	3.00€
S04H4124	24	28	31,8	38	3.10€
S04H4125	25	28	33,8	38	3.50€
S04H4126	26	30	34	42	3.70€
S04H4127	27	28	35,7	42	3.70€
S04H4128	28	30	38	42	3.90€
S04H4129	29	32	38	42	4.60€
S04H4130	30	34	39,8	42	4.60€
S04H4132	32	36	42	42	5.00€
S04H4134	34	40	45	48	6.50€
S04H4136	36	41	48	48	8.50€



S04HD41

Chave de caixa sextavada longa 1/2"

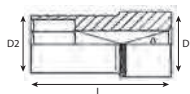

Ref.	Medida (mm)	D1 (mm)	D2 (mm)	L (mm)	Preço
S04HD4109	12	21,8	12,7	76	4.30€
S04HD4110	10	21,8	15,4	76	4.30€
S04HD4111	11	21,8	16,7	76	4.30€
S04HD4112	12	21,8	18	76	4.40€
S04HD4113	13	21,8	19	76	4.50€
S04HD4114	14	22	20,3	76	4.50€
S04HD4115	15	22	21,3	76	4.60€
S04HD4116	16	22	23	76	4.60€
S04HD4117	17	23	23,8	76	4.70€
S04HD4118	18	23	24,8	76	4.70€
S04HD4119	19	24	25,8	76	4.70€
S04HD4120	20	24	28	76	4.70€
S04HD4121	21	24	29	76	4.70€
S04HD4122	22	26	30	76	4.70€
S04HD4123	23	28	31,8	76	4.80€
S04HD4124	24	28	31,8	76	4.80€
S04HD4125	25	28	33,8	76	6.70€
S04HD4126	26	28	33,8	76	6.90€
S04HD4127	27	28	35,7	76	7.10€
S04HD4128	28	30	38	76	7.90€
S04HD4130	30	34	39,8	76	8.40€
S04HD4132	32	36	42	76	9.70€

S04H61

Chave de caixa sextavada 3/4"

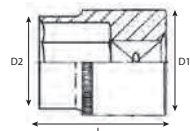

Ref.	Medida (mm)	D1 (mm)	D2 (mm)	L (mm)	Preço
S04H6119	19	30	36	49,5	6.60€
S04H6121	21	32	36	49,5	6.60€
S04H6122	22	33	36	49,5	7.00€
S04H6124	24	35	36	49,5	7.20€
S04H6127	27	38	36	52	7.70€
S04H6128	28	39	36	52	7.80€
S04H6130	30	42	38	54	8.40€
S04H6132	32	44	38	56	8.60€
S04H6134	34	46	38	58	10.40€
S04H6136	36	50	42	58	10.60€
S04H6138	38	52	45	60	11.70€
S04H6141	41	56	45	64	12.40€
S04H6146	46	62	48	68	15.60€
S04H6150	50	68	48	72	17.50€
S04H6152	52	69	48	73	23.40€



S04H63

Chave de caixa 3/4" - 12 faces

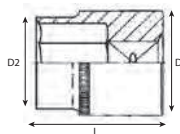

Ref.	Medida (mm)	D1 (mm)	D2 (mm)	L (mm)	Preço
S04H6319	19	30	36	49,5	6.30€
S04H6321	21	32	36	49,5	6.40€
S04H6322	22	33	36	49,5	6.40€
S04H6323	23	34	36	49,5	6.40€
S04H6324	24	35	36	49,5	6.50€
S04H6325	25	37	36	50	7.00€
S04H6326	26	37	36	50	7.10€
S04H6327	27	38	36	52	7.60€
S04H6329	29	40	38	53	7.70€
S04H6330	30	42	38	54	8.30€
S04H6332	32	44	38	56	8.50€
S04H6334	34	46	38	58	10.00€
S04H6336	36	50	42	58	10.70€
S04H6338	38	52	45	60	11.30€
S04H6341	41	56	45	64	12.80€
S04H6346	46	62	48	68	16.40€
S04H6350	50	68	48	72	17.60€
S04H6355	55	74	48	76	12.60€
S04H6356	56	75	48	76	23.40€
S04H6360	60	70	48	78	25.80€
S04H6365	65	87	60	85	37.90€



S04H64

Chave de caixa 3/4" - 12 faces (em polegadas)

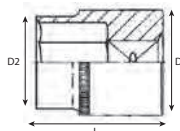

Ref.	Medida	D1 (mm)	D2 (mm)	L (mm)	Preço
S04H6419	3/4"	30	36	49,5	7.20€
S04H6421	13/16"	32	36	49,5	7.20€
S04H6422	7/8"	33	36	49,5	7.20€
S04H6424	15/16"	34	36	49,5	7.20€
S04H6426	1"	35	36	49,5	7.50€
S04H6427	1-1/16"	38	36	52	7.50€
S04H6429	1-1/18"	40	38	53	7.80€
S04H6430	1-3/16"	42	38	54	7.80€
S04H6432	1-1/4"	44	38	56	8.00€
S04H6433	1-5/16"	46	38	56	8.20€
S04H6435	1-3/8"	48	42	58	9.60€
S04H6436	1-7/16"	50	42	58	9.80€
S04H6438	1-1/2"	52	45	60	10.60€
S04H6440	1-9/16"	52	45	60	11.70€
S04H6441	1-5/8"	56	45	64	11.70€
S04H6443	1-11/16"	56	45	64	12.50€
S04H6444	1-3/4"	56	45	64	13.00€
S04H6446	1-13/16"	62	48	68	13.70€
S04H6447	1-7/8"	62	48	68	17.30€
S04H6450	2"	68	48	72	17.50€
S04H6456	2/14"	75	48	76	22.70€



S04H83

Chave de caixa 1" - 12 faces

Ref.	Medida (mm)	D1 (mm)	D2 (mm)	L (mm)
S04H8355	55	76	57	80
S04H8360	60	82	57	84
S04H8365	65	88	57	87

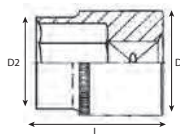
 Preço
 31.20€
 36.80€
 41.20€

S05HD41

Chave de caixa sextavada longa 1/2"

Ref.	Medida (mm)	D1 (mm)	D2 (mm)	L (mm)
S05HD4110	10	21,8	15,4	76
S05HD4111	11	21,8	16,7	76
S05HD4112	12	21,8	18	76
S05HD4113	13	21,8	19	76
S05HD4117	17	23,8	23,8	76
S05HD4118	18	24,8	16,7	76
S05HD4119	19	25,8	25,8	76
S05HD4120	20	27,9	27,9	76
S05HD4121	21	27,9	27,9	76
S05HD4122	22	30	30	76
S05HD4123	23	31,8	31,8	76
S05HD4124	24	31,8	31,8	76
S05HD4127	27	36	36	76
S05HD4130	30	40	40	76
S05HD4132	32	42	42	76

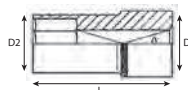
 Preço
 3.90€
 3.90€
 4.00€
 4.10€
 4.50€
 4.50€
 4.50€
 4.70€
 4.90€
 5.00€
 5.90€
 7.50€
 8.60€
 8.60€
 9.20€

S04HD411S 57.10€

Jogo de 10 chaves de caixa longas de 1/2" - 6 faces

Composição:

S04HD4 Chaves: 10; 11; 13; 14; 15; 17; 19; 21; 22 e 24mm



S05H4113S 41.10€

Jogo de 13 chaves de caixa de 1/2" - 12 faces

Composição:

S05H4 Chaves: 10; 12; 13; 14; 15; 16; 17; 18; 19; 20; 21; 22 e 24mm



S05H4213S 51.60€

Jogo de 13 chaves de caixa de 1/2" SAE

Composição:

Chaves: 3/8"; 7/16"; 1/2"; 9/16"; 5/8"; 11/16"; 3/4"; 13/16"; 7/8"; 15/16"; 1"; 1-1/16" e 1-1/8"



S05HD4113S 81.40€

Jogo de 13 chaves de caixa longas 1/2" - 6 faces

Composição:

S05HD4 Chaves: 11; 13; 14; 15; 17; 19; 21; 22; 23; 24; 27; 30 e 32mm



S05HD4213S 62.20€

Jogo de 13 chaves de caixa longas 1/2" SAE

Composição:

Chaves: 7/16"; 1/2"; 9/16"; 5/8"; 11/16"; 3/4"; 13/16"; 7/8"; 15/16"; 1"; 1-1/16"; 1-1/8" e 1-1/4"



S06H37S 20.10€

Jogo de 7 chaves de caixa para parafusos torx 3/8"

Composição:

S06H3 Chaves: E10; E11; E12; E14; E16; E18 e E20



S06H49S 31.80€

Jogo de 9 chaves de caixa para parafusos torx 1/2"

Composição:

S06H4 Chaves: E10; E11; E12; E14; E16; E18; E20; E22 e E24



S66H41

Chaves de caixa de 1/2" - 12 faces

Ref.	Medida (mm)	Preço
S66H4108	8	1.50€
S66H4109	9	1.50€
S66H4110	10	1.60€
S66H4111	11	1.70€
S66H4112	12	1.70€
S66H4113	13	1.70€
S66H4114	14	1.70€
S66H4115	15	1.70€
S66H4116	16	1.80€
S66H4117	17	1.90€
S66H4118	18	2.10€
S66H4119	19	2.10€
S66H4120	20	2.60€
S66H4121	21	2.60€
S66H4122	22	2.80€
S66H4124	24	3.60€
S66H4125	25	4.10€
S66H4126	26	4.60€
S66H4127	27	4.70€
S66H4128	28	4.80€
S66H4130	30	5.10€
S66H4132	32	6.20€
S66H4136	36	8.60€

Novo



S66HD41

Chaves de caixa longas de 1/2" - 12 faces



Ref.	Medida (mm)	Preço
S66HD4110	10	2.70€
S66HD4111	11	2.90€
S66HD4112	12	2.90€
S66HD4113	13	3.00€
S66HD4114	14	3.00€
S66HD4115	15	3.00€
S66HD4116	16	3.10€
S66HD4117	17	3.40€
S66HD4118	18	3.60€
S66HD4119	19	3.60€
S66HD4120	20	3.70€
S66HD4121	21	3.90€
S66HD4122	22	4.70€
S66HD4123	23	4.70€
S66HD4124	24	4.70€
S66HD4127	27	6.00€
S66HD4130	30	7.50€
S66HD4132	32	8.10€



PHILLIPS	FENDA	TORX	TORX TEMP.	HEXAGONAL	XZN
----------	-------	------	------------	-----------	-----



S06H2

Chave de caixa torx 1/4"

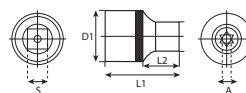

Ref.	Medida	D1 (mm)	D2 (mm)	L1 (mm)	L2 (mm)	Preço
S06H204	E4	12	6,2	25	11	1.40€
S06H205	E5	12	7,2	25	11	1.40€
S06H206	E6	12	8,2	25	11	1.40€
S06H207	E7	12	9	25	11	1.40€
S06H208	E8	12	10,3	25	11	1.40€
S06H210	E10					1.40€
S06H211	E11					1.40€

S06H3

Chave de caixa torx 3/8"



Ref.	Medida	D1 (mm)	D2 (mm)	L1 (mm)	Preço
S06H306	E6	17	11,2	28	1.90€
S06H307	E7	17	11,2	28	1.90€
S06H308	E8	17	11,2	28	1.90€
S06H310	E10	17	13,2	28	1.90€
S06H311	E11	17	13,8	28	1.90€
S06H312	E12	17	14,8	28	1.90€
S06H314	E14	18	16,8	28	1.90€
S06H316	E16	20	18,8	28	1.90€
S06H318	E18	22	20,8	28	1.90€
S06H320	E20	24	22,8	28	2.10€

S06H4

Chave de caixa torx 1/2"



Ref.	Medida	D1 (mm)	D2 (mm)	L1 (mm)	L2 (mm)	Preço
S06H410	E10	22	13,2	38	17	2.60€
S06H411	E11	22	13,9	38	17	2.70€
S06H412	E12	22	15	38	17	2.70€
S06H414	E14	22	16,7	38	17	2.70€
S06H416	E16	22	18,8	38	17	2.70€
S06H418	E18	22	20,8	38	17	2.70€
S06H420	E20	22	23	38	17	2.90€
S06H422	E22	22	25	38	17	3.00€
S06H424	E24	22	27	38	17	3.80€



S07H2

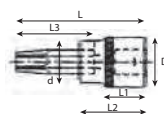

Chave de caixa bit torx 1/4" - 37mm



Ref.	Medida	L1 (mm)	L2 (mm)	L3 (mm)	L (mm)	D (mm)	d (mm)	Preço
S07H206	T6	13	19	25	37	12	10,8	1.20€
S07H207	T7	13	19	25	37	12	10,8	1.20€
S07H208	T8	13	19	25	37	12	10,8	1.20€
S07H209	T9	13	19	25	37	12	10,8	1.20€
S07H210	T10	13	19	25	37	12	10,8	1.20€
S07H215	T15	13	19	25	37	12	10,8	1.20€
S07H220	T20	13	19	25	37	12	10,8	1.20€
S07H225	T25	13	19	25	37	12	10,8	1.20€
S07H227	T27	13	19	25	37	12	10,8	1.20€
S07H230	T30	13	19	25	37	12	10,8	1.20€
S07H240	T40	13	19	25	37	12	10,8	1.20€

S07H3

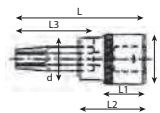
Chave de caixa bit torx 3/8" - 48mm



Ref.	Medida	L1 (mm)	L2 (mm)	L3 (mm)	L (mm)	D (mm)	d (mm)	Preço
S07H310	T10	16,5	26	30	48	18	13,8	1.40€
S07H315	T15	16,5	26	30	48	18	13,8	1.40€
S07H320	T20	16,5	26	30	48	18	13,8	1.40€
S07H325	T25	16,5	26	30	48	18	13,8	1.40€
S07H327	T27	16,5	26	30	48	18	13,8	1.40€
S07H330	T30	16,5	26	30	48	18	13,8	1.40€
S07H340	T40	16,5	26	30	48	18	13,8	1.40€
S07H345	T45	16,5	26	30	48	18	15,8	1.70€
S07H350	T50	16,5	26	30	48	18	15,8	1.80€
S07H355	T55	16,5	26	30	48	18	16,1	1.80€
S07H360	T60	16,5	26	30	48	18	16,1	2.00€

S07H4

Chave de caixa bit torx 1/2" - 55mm



Ref.	Medida	L1 (mm)	L2 (mm)	L3 (mm)	L (mm)	D (mm)	d (mm)	Preço
S07H420	T20	20	38	30	55	22	15	2.60€
S07H425	T25	20	38	30	55	22	15	2.60€
S07H427	T27	20	38	30	55	22	15	2.60€
S07H430	T30	20	38	30	55	22	15	2.70€
S07H440	T40	20	38	30	55	22	15	2.70€
S07H445	T45	20	38	30	55	22	15	2.80€
S07H450	T50	20	38	30	55	22	15	2.80€
S07H455	T55	20	38	30	55	22	17	2.80€
S07H460	T60	20	38	30	55	24	22	3.00€
S07H470	T70	20	38	30	55	24	22	3.20€



S07H43



Chave de caixa bit torx 1/2" - 100mm



Ref.	Medida	L1 (mm)	L2 (mm)	L3 (mm)	L (mm)	D (mm)	d (mm)	Preço
S07H4320	T20	20	38	75	100	24	15	3.80€
S07H4325	T25	20	38	75	100	24	15	3.80€
S07H4327	T27	20	38	75	100	24	15	3.80€
S07H4330	T30	20	38	75	100	24	15	3.90€
S07H4340	T40	20	38	75	100	24	15	3.90€
S07H4345	T45	20	38	75	100	24	15	3.90€
S07H4350	T50	20	38	75	100	24	15	3.90€
S07H4352	T52	20	38	75	100	24	15	3.90€
S07H4355	T55	20	38	75	100	24	17	3.90€
S07H4360	T60	20	38	75	100	24	22	4.50€
S07H4370	T70	20	38	75	100	24	22	4.60€



S09H2



Chave de caixa bit hexagonal 1/4" - 37mm

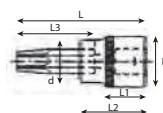

Ref.	Medida	L1 (mm)	L2 (mm)	L3 (mm)	L (mm)	D (mm)	d (mm)	Preço
S09H203	H3	13	19	25	37	12	10,8	1.30€
S09H204	H4	13	19	25	37	12	10,8	1.30€
S09H205	H5	13	19	25	37	12	10,8	1.30€
S09H206	H6	13	19	25	37	12	10,8	1.30€
S09H207	H7	13	19	25	37	12	10,8	1.30€

S09H3



Chave de caixa bit hexagonal 3/8" - 48mm



Ref.	Medida	L1 (mm)	L2 (mm)	L3 (mm)	L (mm)	D (mm)	d (mm)	Preço
S09H303	H3	16,5	26	30	48	18	13,8	1.50€
S09H304	H4	16,5	26	30	48	18	13,8	1.50€
S09H305	H5	16,5	26	30	48	18	13,8	1.50€
S09H306	H6	16,5	26	30	48	18	13,8	1.50€
S09H307	H7	16,5	26	30	48	18	15,8	1.50€
S09H308	H8	16,5	26	30	48	18	15,8	1.70€
S09H310	H10	16,5	26	30	48	18	16,1	1.70€
S09H312	H12	16,5	26	30	48	18	16,1	1.90€
S09H314	H14	16,5	26	30	48	18	16,1	2.20€



S09H4

Chave de caixa bit hexagonal 1/2" - 55mm



Ref.	Medida	L1 (mm)	L2 (mm)	L3 (mm)	L (mm)	D (mm)	d (mm)	Preço
S09H404	H4	20	38	30	55	24	15	2.80€
S09H405	H5	20	38	30	55	24	15	2.80€
S09H406	H6	20	38	30	55	24	15	2.80€
S09H407	H7	20	38	30	55	24	15	2.80€
S09H408	H8	20	38	30	55	24	15	2.80€
S09H410	H10	20	38	30	55	24	17,8	2.90€
S09H412	H12	20	38	30	55	24	22	3.20€
S09H414	H14	20	38	30	55	24	22	3.20€
S09H416	H16	20	38	30	55	24	22	3.60€
S09H417	H17	20	38	30	55	24	22	4.20€
S09H419	H19	20	38	30	55	24	22	4.90€

S09H43



Chave de caixa bit hexagonal 1/2" - 100mm



Ref.	Medida	L1 (mm)	L2 (mm)	L3 (mm)	L (mm)	D (mm)	d (mm)	Preço
S09H4304	H4	20	38	75	100	24	15	3.90€
S09H4305	H5	20	38	75	100	24	15	3.90€
S09H4306	H6	20	38	75	100	24	15	3.90€
S09H4307	H7	20	38	75	100	24	15	3.90€
S09H4308	H8	20	38	75	100	24	15	3.90€
S09H4309	H9	20	38	75	100	24	15	4.10€
S09H4310	H10	20	38	75	100	24	20,8	4.10€
S09H4312	H12	20	38	75	100	24	22	4.10€
S09H4314	H14	20	38	75	100	24	22	4.30€
S09H4316	H16	20	38	75	100	24	22	5.20€
S09H4317	H17	20	38	75	100	24	22	5.70€
S09H4319	H19	20	38	75	100	24	22	8.10€

S10H2

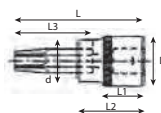
Chave de caixa bit fenda 1/4" - 37mm



Ref.	Medida (mm)	L1 (mm)	L2 (mm)	L3 (mm)	L (mm)	D (mm)	d (mm)	Preço
S10H230	3	13	21	25	37	12	10,8	1.30€
S10H235	3,5	13	21	25	37	12	10,8	1.30€
S10H240	4	13	21	25	37	12	10,8	1.30€
S10H245	4,5	13	21	25	37	12	10,8	1.30€
S10H250	5	13	21	25	37	12	10,8	1.30€
S10H255	5,5	13	21	25	37	12	10,8	1.30€
S10H260	6	13	21	25	37	12	10,8	1.30€
S10H270	7	13	21	25	37	12	10,8	1.40€



S10H3

Chave de caixa bit fenda 3/8" - 48mm

Ref.	Medida (mm)	L1 (mm)	L2 (mm)	L3 (mm)	L (mm)	D (mm)	d (mm)	Preço
S10H340	4	15,5	26,5	30	48	18	13,8	1.30€
S10H350	5	15,5	26,5	30	48	18	13,8	1.30€
S10H355	5,5	15,5	26,5	30	48	18	13,8	1.40€
S10H360	6	15,5	26,5	30	48	18	13,8	1.40€
S10H370	7	15,5	26,5	30	48	18	13,8	1.40€
S10H380	8	15,5	26,5	30	48	18	15,8	1.40€
S10H3100	10	15,5	26,5	30	48	20	17,8	1.60€
S10H3120	12	15,5	26,5	30	48	20	17,8	2.00€



S10H4

Chave de caixa bit fenda 1/2" - 55mm

Ref.	Medida (mm)	L1 (mm)	L2 (mm)	L3 (mm)	L (mm)	D (mm)	d (mm)	Preço
S10H480	8	20	36	30	55	22	17,8	2.70€
S10H490	9	20	36	30	55	22	17,8	2.90€
S10H4100	10	20	36	30	55	22	17,8	3.00€
S10H4110	11	20	36	30	55	24	20,8	3.10€
S10H4120	12	20	36	30	55	24	20,8	3.10€



S11H2

Chave de caixa bit phillips 1/4" - 37mm

Ref.	Medida	L1 (mm)	L2 (mm)	L3 (mm)	L (mm)	D (mm)	d (mm)	Preço
S11H200	PH0	13	19	25	37	12	10,8	1.30€
S11H201	PH1	13	19	25	37	12	10,8	1.30€
S11H202	PH2	13	19	25	37	12	10,8	1.30€
S11H203	PH3	13	19	25	37	12	10,8	1.30€



S11H3

Chave de caixa bit phillips 3/8" - 48mm

Ref.	Medida	L1 (mm)	L2 (mm)	L3 (mm)	L (mm)	D (mm)	d (mm)	Preço
S11H300	PH0	16,5	26	30	48	18	13,8	1.40€
S11H301	PH1	16,5	26	30	48	18	13,8	1.40€
S11H302	PH2	16,5	26	30	48	18	13,8	1.40€
S11H303	PH3	16,5	26	30	48	18	15,8	1.40€
S11H304	PH4	16,5	26	30	48	18	15,8	1.60€

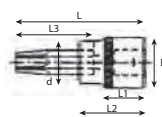

S11H4

Chave de caixa bit phillips 1/2" - 55mm

Ref.	Medida	L1 (mm)	L2 (mm)	L3 (mm)	L (mm)	D (mm)	d (mm)	Preço
S11H402	PH2	55	38	30	55	24	15	2.70€
S11H403	PH3	55	38	30	55	24	15	2.70€
S11H404	PH4	55	38	30	55	24	15	2.70€



S07H45

Chave de caixa bit torx de 1/2"

Ref.	Medida	Comp. (mm)	Preço
S07H4530	T30	200	6.50€
S07H4540	T40	200	6.50€
S07H4545	T45	200	7.20€

S08H311S

Jogo de 11 bits de 1/4" e 3/8" torx tamperproof

Composição:

Chaves de 1/4": T8; T10; T15; T20; T25 e T27

Chaves de 3/8": T30; T40; T45; T50 e T55



16.70€

S49H4

Chave de caixa bits estriado XZN de 1/2"

Ref.	Medida	Comp. (mm)	Preço
S49H4105	M5	55	3.50€
S49H4106	M6	55	3.60€
S49H4108	M8	55	3.60€
S49H4110	M10	55	3.60€
S49H4112	M12	55	3.70€
S49H4114	M14	55	4.30€
S49H4116	M16	55	5.00€
S49H4308	M8	100	5.00€
S49H4310	M10	100	5.30€
S49H4312	M12	100	5.50€
S49H4314	M14	100	7.00€
S49H4318	M18	100	10.60€

S50H3106S

Jogo de 6 bits hexagonais 3/8"

Composição:

Chaves: 4; 5; 6; 7; 8 e 10 mm



15.20€

S50H3206S

Jogo de 6 bits hexagonais 3/8" SAE

Composição:

Chaves: 5/32"; 3/16"; 7/32"; 1/4"; 5/16" e 3/8"



14.40€

S54H5509S

Jogo de 9 chaves de torx de 1/4" e 3/8"

Composição:

S54H2 Chaves de 1/4": T10; T15; T20 e T25

S54H3 Chaves de 3/8": T25; T30; T40; T45 e T50



17.40€

S63H33

Chave de caixa Ribe 3/8" - 90mm

Ref.	Medida	Comp. (mm)	Preço
S63H3306	M6	90	1.90€
S63H3307	M7	90	2.20€
S63H3308	M8	90	2.20€
S63H3310	M10	90	3.00€

S63H43

Chave de caixa Ribe 1/2" - 100mm

Ref.	Medida	Comp. (mm)	Preço
S63H4306	M6	100	3.70€
S63H4307	M7	100	3.80€
S63H4308	M8	100	3.90€
S63H4310	M10	100	4.10€
S63H4312	M12	100	4.30€
S63H4313	M13	100	4.50€

S63H44

Chave de caixa Ribe 1/2" - 55mm

Ref.	Medida	Comp. (mm)	Preço
S63H4405	M5	55	3.10€
S63H4406	M6	55	3.10€
S63H4407	M7	55	3.10€
S63H4408	M8	55	3.20€
S63H4409	M9	55	3.30€
S63H4410	M10	55	3.50€
S63H4412	M12	55	4.10€
S63H4413	M13	55	4.80€
S63H4414	M14	55	5.90€



S63H4507S

26.20€

Jogo de 7 bits longos 6 caneluras (Ribe) 3/8" e 1/2"

Composição:

Bits 3/8" de 90 mm: M6; M7; M8 e M10

Bits 1/2" de 100 mm: M12; M13 e M14



S63H46

Chave de caixa Ribe 1/2" - 100mm



Ref.	Medida	Comp. (mm)	Preço
S63H4605	M5	100	3.70€
S63H4606	M6	100	3.80€
S63H4607	M7	100	3.80€
S63H4608	M8	100	3.90€
S63H4609	M9	100	4.00€
S63H4610	M10	100	4.00€
S63H4612	M12	100	5.00€
S63H4613	M13	100	6.00€
S63H4614	M14	100	6.10€

S63H47

Chave de caixa Ribe 1/2" - 140mm



Ref.	Medida	Comp. (mm)	Preço
S63H4708	M8	140	4.60€
S63H4709	M9	140	4.60€
S63H4710	M10	140	4.60€
S63H4712	M12	140	5.80€
S63H4713	M13	140	6.70€
S63H4714	M14	140	6.70€

S63H48

Chave de caixa Ribe 1/2" - 200mm



Ref.	Medida	Comp. (mm)	Preço
S63H4808	M8	200	5.30€
S63H4809	M9	200	5.50€
S63H4810	M10	200	5.60€
S63H4812	M12	200	6.90€
S63H4813	M13	200	8.10€
S63H4814	M14	200	8.20€

C-DMH



Barra magnética para chaves de caixa

Ref.	Medida	Capacid. (chaves)	Preço
C-DMH212	1/4"	12	19.40€
C-DMH314	3/8"	14	26.90€
C-DMH414	1/2"	12	29.00€

MSH



Régua suporte para chaves de caixa

Ref.	Medida	Capacid. (chaves)	Preço
MSH1214	1/2"	14	2.60€
MSH1414	1/4"	14	2.10€
MSH3814	3/8"	14	2.30€

S64H4

Chave de caixa bits estriado XZN de 1/2"



Ref.	Medida	Comp. (mm)	Preço
S64H4104	M4	55	3.10€
S64H4105	M5	55	3.10€
S64H4106	M6	55	3.10€
S64H4107	M7	55	3.10€
S64H4109	M9	55	3.20€
S64H4112	M12	55	3.80€
S64H4113	M13	55	4.60€
S64H4114	M14	55	4.90€
S64H4204	M4	100	3.70€
S64H4205	M5	100	3.90€
S64H4206	M6	100	4.00€
S64H4207	M7	100	4.10€
S64H4208	M8	100	4.20€
S64H4209	M9	100	4.30€
S64H4210	M10	100	4.40€
S64H4212	M12	100	5.20€
S64H4214	M14	100	6.30€
S64H4216	M16	100	6.80€
S64H4218	M18	100	12.00€
S64H4705	M5	140	4.30€
S64H4706	M6	140	4.30€
S64H4708	M8	140	4.70€
S64H4709	M9	140	4.70€
S64H4710	M10	140	4.70€
S64H4712	M12	140	5.60€
S64H4714	M14	140	6.70€
S64H4808	M8	200	5.30€
S64H4810	M10	200	5.30€
S64H4812	M12	200	6.80€
S64H4814	M14	200	7.80€



S15H
Cardan

Ref.	Medida	D1 (mm)	D2 (mm)	L (mm)	Acabamento	Preço
S15H240	1/4"	14	14	35	Mate	2.90€
S15H356	3/8"	18	18	49	Mate	4.30€
S15H472	1/2"	25	25	69	Mate	5.60€
S15H6109	3/4"	39,7	39,5	106,2	Polido	30.20€

S16H
Adaptador

Ref.	Medida	A (mm)	D1 (mm)	D2 (mm)	L (mm)	Acabamento	Preço
S16H1234	1/2" F - 3/4" M	19	12,7	27	45	Polido	4.90€
S16H1238	1/2" F - 3/8" M	9,52	12,7	22	34	Mate	1.60€
S16H1438	1/4" F - 3/8" M	9,52	6,35	14	25	Mate	1.30€
S16H3410	3/4" F - 1" M	25,3	19,05	39,7	59,6	Polido	12.50€
S16H3412	3/4" F - 1/2" M	12,7	19,05	35	51	Polido	8.10€
S16H3812	3/8" F - 1/2" M	12,7	9,52	17	35	Mate	1.50€
S16H3814	3/8" F - 1/4" M	6,35	9,75	18,6	28	Mate	1.20€

S16H
Adaptador

Ref.	Medida	A (mm)	D1 (mm)	D2 (mm)	L (mm)	Acabamento	Preço
S16H302	1/4" M - 3/8" F	6,35	9,75	18,6	28	Mate	2.50€
S16H304	1/2" M - 3/8" F	12,7	9,75	23,5	43,7	Mate	3.60€
S16H403	3/8" M - 1/2" F	9,5	12,9	23,5	40	Mate	3.50€

S17H
Chave de velas

Ref.	Medida	A1 (mm)	D1 (mm)	D2 (mm)	L (mm)	Acabamento	Preço
S17H3116	3/8"	16	21,7	18,8	65	Mate	2.00€
S17H3121	3/8"	21	27,6	21,5	65	Mate	2.80€
S17H4116	1/2"	16	21,8	21,8	65	Mate	1.90€
S17H4121	1/2"	21	27,6	23,6	65	Mate	2.70€

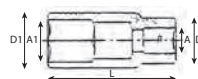

Ferramenta de aperto

S17H3414

7.00€

Chave de velas 12 faces 3/8"

Medida: 14mm
Acabamento: Mate



S21H

Extensão

Ref.	Quadra	Medida (mm)	Acabamento	Preço
S21H4150	1/2"	50	Mate	3.70€
S21H4175	1/2"	75	Mate	4.30€
S21H41125	1/2"	125	Mate	5.20€
S21H41250	1/2"	250	Mate	7.90€

S22H

Cabo articulado

Ref.	Quadra	Medida (mm)	Acabamento	Preço
S22H21150	1/4"	150	Mate	7.00€
S22H31200	3/8"	200	Mate	9.30€
S22H41375	1/2"	375	Mate	17.90€
S22H41450	1/2"	450	Mate	21.70€

Novo

S22H

Cabo articulado

Ref.	Quadra	Medida (mm)	Acabamento	Preço
S22H41600	1/2"	600	Polido	30.60€
S22H6500	3/4"	500	Polido	43.50€

S22H41600RK

12.00€

Kit de reparação para cabo articulado S22H41600



S22H6500RK

17.30€

Kit de reparação para cabo articulado S22H6500



S22H21130RK

3.00€

Kit de reparação para cabo articulado S22H21130 e S22H21150



S22H41375RK

3.80€

Kit de reparação para cabo articulado S22H41375 e S22H41450



Novo

S22H31200RK

3.40€

Kit de reparação para cabo articulado S22H31200

S23H

Cabo "T" correção

Ref.	Quadra	Medida (mm)	Acabamento	Preço
S23H21115	1/4"	115	Mate	2.30€
S23H31200	3/8"	200	Mate	5.10€
S23H41250	1/2"	250	Mate	6.80€
S23H41300	1/2"	300	Mate	7.60€
S23H6450	3/4"	450	Polido	25.10€
S23H6500	3/4"	500	Polido	27.30€
S23H8550	1"	550	Polido	52.00€



S24H

Extensões

Ref.	Quadra	Medida (mm)	Acabamento	Preço
S24H250	1/4"	50	Mate	1.30€
S24H375	3/8"	75	Mate	2.00€
S24H450	1/2"	50	Mate	2.80€
S24H475	1/2"	75	Mate	3.30€
S24H2100	1/4"	100	Mate	1.50€
S24H2150	1/4"	150	Mate	1.80€
S24H3150	3/8"	150	Mate	2.90€
S24H3200	3/8"	200	Mate	3.40€
S24H3250	3/8"	250	Mate	4.10€
S24H4125	1/2"	125	Mate	4.10€
S24H4224	1/2"	610	Polido	26.80€
S24H4250	1/2"	250	Mate	5.10€
S24H6100	3/4"	100	Polido	11.50€
S24H6200	3/4"	200	Polido	15.40€
S24H6400	3/4"	400	Polido	27.10€
S24H8200	1"	200	Polido	30.10€



S26H2150

3.00€

Punho de 1/4"



S26H2280

14.50€

Punho 1/4" dupla função fixo/ cardan



AG010184F

6.50€

Chave flexível ponta macho de 1/4"



AG0101

Chave flexível de punho com caixa



Ref.	Medida (mm)	Preço
AG010184B	6	7.20€
AG010184C	7	7.20€
AG010184D	8	7.20€
AG010184E	10	7.20€

S27H

Extensões flexíveis



Ref.	Quadra	Medida (mm)	Preço
S27H2	1/4"	145	3.50€
S27H3	3/8"	193	20.60€
S27H4	1/2"	205	21.10€

S40H

Chave em T



Ref.	Medida (mm)	Comp. (mm)	Comp. Punho (mm)	Preço
S40H108	8	300	200	11.10€
S40H110	10	300	200	11.10€
S40H112	12	300	200	11.10€
S40H114	14	300	200	11.10€

S40T

Chave em T com ponta flexível



Ref.	Medida (mm)	Preço
S40T108	8	24.50€
S40T110	10	24.50€
S40T112	12	24.50€
S40T113	13	24.50€
S40T114	14	24.50€
S40T117	17	24.50€
S40T119	19	24.50€

Novo
S40TB-1

Travessa para S40T



4.70€

S40T109S

Jogo de 9 peças "T" flexíveis

Composição/ medidas em mm:

8; 10; 12; 13; 14; 17 e 19

Travessões P/T



158.20€

S41H41

Manivela quadra macho de 1/2"



12.80€

S42M

Extensões magnéticas



Ref.	Quadra	Medida (mm)	Preço
S42M475	1/2"	75	10.30€
S42M4125	1/2"	125	10.30€
S42M4250	1/2"	250	14.50€

S42M403S

Jogo de 3 extensões magnéticas 1/2"

Composição/ medidas em mm:

75; 125 e 250



38.00€

S44H2206

Porta bits 1/4"

Quadra de 1/4" para uso em bits com encabadouro de 1/4"



1.10€

S44H3110A

Porta bits

Quadra: 3/8"

Utilização em bits: 3/8"



3.00€

S44H3206

Porta bits

Quadra: 3/8"

Utilização em bits: 1/4"



2.60€

S44H4110

Porta bits

Quadra: 1/2"

Utilização em bits: 3/8"



2.10€

S60H4304S

45.70€

Jogo de 4 extensões de 1/2"

Composição/ medidas em mm:
75; 125; 250 e 375



R53A-3

Adaptador "macho/macho"

Para aplicação em conjunto com o cabo "T" flexível R53A

Preço

Ref.	Quadra	Compr. (mm)	Preço
R53A-2A	1/4"	20	1.20€
R53A-3A	3/8"	30	1.80€
R53A-4A	1/2"	35	2.50€



R19H3

Chave pata de galo 3/8"

Ref.	Medida (mm)	Preço
R19H3110	10	5.50€
R19H3111	11	5.50€
R19H3112	12	5.50€
R19H3113	13	5.50€
R19H3114	14	5.50€
R19H3115	15	5.50€
R19H3116	16	5.70€
R19H3117	17	5.80€
R19H3118	18	5.90€
R19H3119	19	6.00€



R19H310S

50.10€

Jogo de 10 chaves pata de galo de 3/8"

Composição/ medidas em mm:

Chaves: 10; 11; 12; 13; 14; 15; 16; 17; 18 e 19



S03A4111S

43.50€

Jogo de 11 chaves de impacto de 1/2"

Composição/ medidas (mm):

S03A4 Chaves: 10; 11; 12; 13; 14; 16; 17; 19; 21; 22 e 24



S01U41

Cardan de impacto 1/2"

Ref.	Medida (mm)	Compr. (mm)	Preço
S01U4113	13	70	13.10€
S01U4114	14	70	13.30€
S01U4115	15	70	13.30€
S01U4116	16	70	13.30€
S01U4117	17	70	13.30€
S01U4119	19	70	14.30€
S01U4121	21	70	14.90€
S01U4122	22	70	15.60€



S01U4108S

114.80€

Jogo 8 chaves/ cardans impacto 1/2"

Composição/ medidas em mm:

Chaves: 13; 14; 15; 16;
17; 19; 21 e 22



S03A2

Chave de impacto 1/4"

Ref.	Quadra	Medida (mm)	Preço
S03A2110	1/4"	10	1.70€
S03A2112	1/4"	12	1.80€
S03A2114	1/4"	14	2.00€



S03AD4111S

68.50€

Jogo de 11 chaves de impacto longas de 1/2"

Composição/ medidas (mm):

S03AD4 Chaves: 10; 11; 12; 13; 14; 16; 17; 19; 21; 22 e 24



S03A4A

Adaptador de 1/2"

Ref.	Quadra	Preço
S03A4A3	3/8"	4.90€
S03A4A6	3/4"	6.50€



S03A4U4

12.00€

Cardan de 1/2"

S03A4UT3S

36.80€

Jogo de 3 cardans impacto

 Composição/ medidas:
1/4"; 3/8" e 1/2"

S03A

Cardan de impacto



Ref.	Quadra	Preço
S03A2UT	1/4"	9.90€
S03A3UT	3/8"	11.50€
S03A4UT	1/2"	15.00€

S03A4E

Extensão



Ref.	Quadra	Medida (mm)	Preço
S03A4E4	1/2"	100	5.90€
S03A4E5	1/2"	125	6.20€
S03A4E6	1/2"	150	7.70€
S03A4E8	1/2"	200	8.60€

S03A4211S

44.90€

Jogo de 11 chaves impacto 1/2" SAE

Composição:

Ref.	Medida	Ref.	Medida
S03A4210	3/8"	S03AD4219	3/4"
S03A4211	7/16"	S03AD4221	13/16"
S03A4213	1/2"	S03AD4222	7/8"
S03A4214	9/16"	S03AD4224	15/16"
S03A4216	5/8"	S03AD4226	1"
S03A4217	11/16"		

S03AD4414S

108.10€

Jogo de 14 chaves longas impacto 1/2" SAE

Composição/ medidas:

 Chaves: 3/8"; 7/16"; 1/2"; 9/16"; 5/8"; 11/16"; 3/4";
13/16"; 7/8"; 15/16"; 1"; 1-1/16"; 1-1/8" e 1-1/4"

S03A6108S

91.40€

Jogo de 8 chaves de impacto de 3/4"

Composição/ medidas:

S03A6 Chaves: 26; 27; 29; 30; 32; 35; 36 e 38

S03AD6107S

141.90€

Jogo de 7 chaves de impacto longas de 3/4"

Composição/ medidas:

S03AD6 Chaves: 26; 27; 29;
32; 35; 36 e 38

S03AD6120S

295.00€

Jogo de 20 peças de impacto de 3/4"

Composição/ medidas em mm:

S03AD6 Chaves: 24; 27; 30; 32; 33; 34; 35; 36; 41 e 46
S03A4A6 Adaptador 1/2" - 3/4"
S03A8A6 Adaptador 1" - 3/4"
S03A6U6 Cardan 3/4"
S03A6E Extensão de 3/4" 250 mm
 Pinos
 O'rings

S03A4

Chave impacto 1/2"

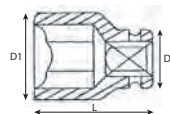

Ref.	Medida (mm)	D1 (mm)	D2 (mm)	L (mm)	Preço
S03A4109	9	15	24	38	3.10€
S03A4110	10	17	24	38	3.10€
S03A4111	11	19	24	38	3.20€
S03A4112	12	20	24	38	3.20€
S03A4113	13	20,8	24	38	3.30€
S03A4114	14	22	24	38	3.30€
S03A4115	15	24	24	38	3.30€
S03A4116	16	24	24	38	3.60€
S03A4117	17	26	26	38	3.70€
S03A4118	18	26	27	38	3.80€
S03A4119	19	28	28	38	4.00€
S03A4120	20	30	30	38	4.10€
S03A4121	21	30	30	38	4.20€
S03A4122	22	32	30	38	4.50€
S03A4123	23	34	30	38	4.80€
S03A4124	24	34	30	43	5.10€
S03A4127	27	38	30	43	7.20€
S03A4129	29	40	30	48	8.20€
S03A4130	30	42	30	48	8.50€
S03A4132	32	44,6	30	48	8.90€

S03AD4

Chave impacto longa 1/2"



Ref.	Medida (mm)	D1 (mm)	D2 (mm)	L (mm)	Preço
S03AD4110	10	17	24	78	5.40€
S03AD4111	11	19	24	78	5.40€
S03AD4112	12	19,6	24	78	5.40€
S03AD4113	13	20,8	24	78	5.40€
S03AD4114	14	22	24	78	5.50€
S03AD4115	15	24	24	78	5.60€
S03AD4116	16	24	24	78	5.70€
S03AD4117	17	26	26	78	5.80€
S03AD4118	18	28	27	78	6.10€
S03AD4119	19	28	28	78	6.20€
S03AD4120	20	30	30	78	6.40€
S03AD4121	21	30	30	78	6.90€
S03AD4122	22	32	30	78	7.20€
S03AD4123	23	33,3	30	78	7.60€
S03AD4124	24	34,6	30	78	8.00€
S03AD4125	25	35,8	30	78	8.90€
S03AD4126	26	37	30	78	10.00€
S03AD4127	27	38	30	78	10.10€
S03AD4128	28	39,5	30	78	10.90€
S03AD4130	30	42	30	78	12.30€
S03AD4132	32	44,6	30	78	12.80€

S03A6

Chave impacto 3/4"

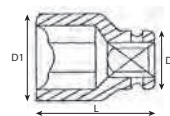

Ref.	Medida (mm)	D1 (mm)	D2 (mm)	L (mm)	Preço
S03A6126	26	41	38	51	8.00€
S03A6127	27	43	40	53	8.80€
S03A6129	29	45	42	53	8.80€
S03A6130	30	46	44	53	9.60€
S03A6132	32	49	44	57	10.40€
S03A6133	33	51	44	57	10.80€
S03A6134	34	51	44	57	11.30€
S03A6135	35	53	44	57	11.70€
S03A6136	36	54	44	57	12.70€
S03A6137	37	55	44	57	13.50€
S03A6138	38	56	44	57	13.50€
S03A6139	39	57,7	44	57	14.60€
S03A6140	40	59	44	57	15.90€
S03A6141	41	60	44	57	16.70€
S03A6142	42	61,4	44	57	19.10€
S03A6143	43	62,7	44	62	19.80€
S03A6144	44	64	44	62	21.20€
S03A6145	45	65	44	62	21.80€
S03A6146	46	66,4	44	62	22.10€
S03A6147	47	67,6	44	67	23.10€
S03A6148	48	68,8	44	67	23.40€
S03A6149	49	70	44	72	25.10€
S03A6150	50	71,4	72	72	26.70€
S03A6151	51	72,8	72	72	31.20€
S03A6152	52	74	72	72	32.30€
S03A6153	53	75	72	72	32.90€
S03A6154	54	76,4	72	72	33.40€
S03A6155	55	77,7	74	74	36.20€
S03A6156	56	79	74	74	38.40€
S03A6157	57	80	74	74	39.60€
S03A6158	58	81,5	75	75	42.30€
S03A6159	59	82,7	75	75	44.60€
S03A6160	60	84	75	75	47.40€
S03A6163	63	87,6	75	75	50.70€
S03A6165	65	90	78	78	53.50€
S03A6167	67	92,7	80	80	61.30€
S03A6170	70	96,4	83	83	63.50€



S03AD6

Chave impacto longa 3/4"

Ref.	Medida (mm)	D1 (mm)	D2 (mm)	L (mm)	Preço
S03AD6124	24	38,9	44	90	17.80€
S03AD6126	26	41,3	44	90	18.40€
S03AD6127	27	42,6	44	90	18.90€
S03AD6129	29	45,1	44	90	18.90€
S03AD6130	30	46,4	44	90	19.90€
S03AD6132	32	48,9	44	90	19.50€
S03AD6133	33	50,6	44	90	20.10€
S03AD6134	34	51,4	44	90	21.20€
S03AD6135	35	52,7	44	90	21.30€
S03AD6136	36	53,9	44	90	22.30€
S03AD6138	38	56,4	44	90	25.20€
S03AD6140	40	58,9	44	90	27.30€
S03AD6141	41	60,1	44	90	27.90€
S03AD6142	42	61,4	44	90	31.80€
S03AD6144	44				34.00€
S03AD6146	46	66,4	44	90	36.20€
S03AD6150	50	71,4	54	90	42.30€



S03A8

Chave impacto 1"

Ref.	Medida (mm)	D1 (mm)	D2 (mm)	L (mm)	Preço
S03A8124	24	41,9	54	58	20.10€
S03A8127	27	45,6	54	58	20.60€
S03A8129	29	48,1	54	60	20.60€
S03A8130	30	49,4	54	60	20.60€
S03A8132	32	51,9	54	60	21.20€
S03A8133	33	53,6	54	60	22.00€
S03A8134	34	54,4	54	62	22.60€
S03A8135	35	55,7	54	62	23.40€
S03A8136	36	56,9	54	62	25.60€
S03A8138	38	59,4	54	65	25.90€
S03A8140	40	110	54	65	26.40€
S03A8141	41	63,1	54	65	26.80€
S03A8144	44	120	54	65	29.00€
S03A8146	46	69,4	54	74	30.10€
S03A8150	50	74,4	54	74	36.80€
S03A8155	55	80,7	54	85	44.60€
S03A8160	60	87,1	54	90	57.90€
S03A8165	65	93,2	54	90	69.10€
S03A8170	70	99,4	54	100	96.60€
S03A8173	73	103,3	86	100	101.40€
S03A8175	75	105,6	86	100	110.30€
S03A8176	76	106,9	86	100	128.10€
S03A8178	78	110	86	100	133.70€
S03A8180	80	111,9	86	100	139.30€
S03A8185	85	118,5	86	110	172.70€
S03A8189	89	123,2	86	110	174.90€
S03A8190	90	124,4	86	110	200.60€
S03A8192	92	126,8	86	110	206.10€
S03A8195	95	129	86	110	228.40€

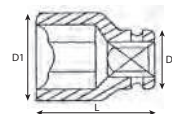

S03AD8

Chave impacto longa 1"



Ref.	Medida (mm)	D1 (mm)	D2 (mm)	L (mm)	Preço
S03AD8117	17	33,1	54	90	26.70€
S03AD8124	24	41,9	54	90	27.90€
S03AD8126	26	43,3	54	90	27.90€
S03AD8127	27	45,6	54	90	27.90€
S03AD8129	29	48,1	54	90	29.00€
S03AD8130	30	49,4	54	90	29.50€
S03AD8132	32	51,9	54	90	30.10€
S03AD8133	33	53,6	54	90	30.10€
S03AD8134	34	54,4	54	90	30.60€
S03AD8135	35	55,7	54	90	31.20€
S03AD8136	36	56,9	54	90	31.80€
S03AD8138	38	59,4	54	90	32.90€
S03AD8140	40	61,9	54	90	34.00€
S03AD8141	41	63,1	54	90	35.10€
S03AD8142	42	64,4	54	90	36.20€
S03AD8146	46	69,4	54	90	40.10€
S03AD8148	48	71,8	54	90	45.70€
S03AD8150	50	74,4	54	90	54.60€
S03AD8155	55	80,7	54	90	67.40€
S03AD8158	58	84,5	54	105	71.90€
S03AD8160	60	87,1	54	120	83.00€
S03AD8165	65	93,2	54	120	93.60€

S05A4H

Bit hexagonal de impacto 1/2"

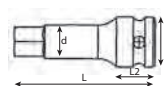

Ref.	Medida	D (mm)	d (mm)	L2 (mm)	L (mm)	Preço
S05A4H4	H4	25	6	22,5	78	8.80€
S05A4H5	H5	25	7	22,5	78	8.90€
S05A4H6	H6	25	8	22,5	78	9.00€
S05A4H7	H7	25	9	22,5	78	9.00€
S05A4H8	H8	25	10,5	22,5	78	9.10€
S05A4H10	H10	25	12,5	22,5	78	9.60€
S05A4H12	H12	25	15	22,5	78	9.60€
S05A4H14	H14	25	17,5	22,5	78	9.60€
S05A4H17	H17	25	21	22,5	78	9.60€
S05A4H18	H18	25	22	22,5	78	9.60€
S05A4H19	H19	25	23	22,5	78	9.60€

S03A6A

Adaptador de 3/4"

Ref.	Quadra	Preço
S03A6A4	1/2"	12.50€
S03A6A8	1"	15.80€



S03A6U6

Cardan de 3/4"

40.90€



S03A6E

Extensão

Ref.	Quadra	Medida (mm)	Preço
S03A6E04	3/4"	100	21.40€
S03A6E08	3/4"	200	24.50€
S03A6E10	3/4"	250	29.00€



S03A8109S

234.00€

Jogo de 9 chaves impacto 1"

Composição/ medidas:

S03A8 Chaves: 24; 27; 30; 32; 35; 38; 41; 46 e 50



S03A8A6

Adaptador 1" - 3/4"

20.60€



S03A8E

Extensão impacto

Ref.	Quadra	Medida (mm)	Preço
S03A8E04	1"	100	31.20€
S03A8E07	1"	175	39.90€
S03A8E10	1"	250	61.00€



S03AD8107S

270.30€

Jogo de 7 chaves longas de impacto 1"

Composição/ medidas:

S03AD8 17; 24; 27; 30; 34; 35 e 38mm
Mala metálica



S03S8

Chave de impacto quadrada

Ref.	Quadra	Medida (mm)	Preço
S03S8117	1"	17	21.10€
S03S8119	1"	19	21.30€
S03S8121	1"	21	21.50€



S03SD8

Chave de impacto longa quadrada

Ref.	Quadra	Medida (mm)	Preço
S03SD8117	1"	17	27.70€
S03SD8119	1"	19	28.00€
S03SD8121	1"	21	28.50€



S05A408S

61.30€

Jogo de 8 chaves de caixa com ponta macho hexagonal de impacto 1/2"

Composição:

S05A4 Chaves: H5; H6; H8; h10; H12; H14; H17 e H19



S05A416S

71.60€

Novo

Jogo de 16 peças ponta macho hexagonal

Composição:

8pcs: 8, 10, 12, 13, 14, 17, 19 mm
7pcs: 5/16", 3/8", 7/16", 1/2", 9/16", 5/8", 3/4"
1 Adaptador impacto 1/2"



S05A6105S

100.30€

Jogo de 5 bits hexagonais de impacto 3/4"

Composição:

S05A6 Chaves: 14; 17; 19; 22 e 24mm de 88mm



S05A6H

Chave de impacto hexagonal de 3/4"



Ref.	Medida (mm)	Comprimento (mm)	Preço
S05A6H14	14	88	17.70€
S05A6H17	17	88	17.70€
S05A6H19	19	88	17.70€
S05A6H22	22	88	17.70€
S05A6H24	24	88	17.70€

S06A4T

Chaves de caixa com ponta macho torx de impacto de 1/2"



Ref.	Medida	Preço
S06A4T20	T20	9.20€
S06A4T27	T27	9.20€
S06A4T30	T30	9.20€
S06A4T40	T40	9.20€
S06A4T45	T45	9.20€
S06A4T50	T50	9.20€
S06A4T55	T55	9.20€
S06A4T60	T60	9.20€
S06A4T70	T70	9.60€
S06A4T80	T80	9.60€

S06A408S

56.10€

Jogo de 8 chaves de caixa com ponta macho torx de impacto 1/2"

Composição:

S06A4 Chaves: T30; T40; T45; T50; T55; T60; T70 e T80

S64A4106S

51.30€

Jogo de 6 chaves de impacto XZN de 1/2"

Composição:

S064A4 3 Chaves: M14; M16 e M18 de 45mm
 3 Chaves: M14; M16 e M18 de 76mm

S64A61

Chave de impacto perfil XZN de 3/4"



Ref.	Medida	Comprimento (mm)	Preço
S64A6116	M16	61	13.40€
S64A6118	M18	61	13.70€

S64A6306S

87.30€

Jogo de 6 chaves de impacto XZN e Torx de 3/4"

Composição:

S064A6 4 Chaves Torx:
 T70; T80; T90 e T100 de 61mm
 2 Chaves XZN:
 M16 e M18 de 61mm

S64A6T

Chave de impacto perfil Torx de 3/4"



Ref.	Medida	Comprimento (mm)	Preço
S64A6T70	T70	61	12.80€
S64A6T90	T90	61	13.70€

S12A4525S

245.10€

Jogo de 25 chaves impacto magnéticas de 1/2"

Composição:

 Chaves de 1/2": 3/8"; 7/16"; 1/2"; 9/16"; 5/8"; 11/16";
 3/4"; 13/16"; 7/8"; 15/16" e 1"
 Chaves de 1/2": 10 a 21mm
 Cardan de 1/2"
 Extensão 80mm

Ferramenta de aperto

S18A4117M

23.40€

Chave impacto magnética de 17 mm de 1/2"



S18A4119M

18.90€

Chave impacto magnética de 19 mm de 1/2"



S18A4121M

18.90€

Chave impacto magnética de 21 mm de 1/2"



S18A4103MS

72.40€

Jogo de 3 chaves impacto magnéticas de 1/2"

Composição:

Chaves: 17; 19 e 21mm



S03AD4317

9.50€

Chave impacto de 17 mm de 1/2"



S03AD4319

9.50€

Chave impacto de 19 mm de 1/2"



S03AD4321

9.50€

Chave impacto de 21 mm de 1/2"



S03AD4303S

32.30€

Jogo de 3 chaves impacto de 1/2"

Composição:

Ref.	Medida (mm)
S03AD4317	17
S03AD4319	19
S03AD4321	21



S03AD4307S

85.20€

Jogo de 7 chaves impacto de 1/2"

Composição:

Ref.	Medida (mm)
S03AD4317	17
S03AD4319	19
S03AD4321	21
S03AD4322	22
S03AD4323	23
S03AD4324	24
S03AD4327	27



S18AD4103S

83.60€

Jogo 3 chaves impacto 1/2" extra longas

Composição:

Ref.
S18AD4117
S18AD4119
S18AD4121



Novo

S03AD4517

20.60€

Chave impacto longa de 17 mm de 1/2"



S03AD4519

20.90€

Chave impacto longa de 19 mm de 1/2"



S03AD4521

21.20€

Chave impacto longa de 21 mm de 1/2"



S46TE80

16.70€

Barra de torque 110Nm de 1/2"

Comprimento: 196mm

Cor: azul



S18A41

Chave de impacto longa para rodas



Ref.	Quadra	Medida (mm)	D (mm)	L (mm)	Cor	Preço
S18A4115	1/2"	15	25	85	Laranja	8.50€
S18A4117	1/2"	17	27	85	Azul	10.70€
S18A4119	1/2"	19	28,5	85	Verde	11.10€
S18A4121	1/2"	21	31	85	Vermelho	11.70€

S18AD41

Chave de impacto extra longa para rodas



Ref.	Quadra	Medida (mm)	D (mm)	L (mm)	Cor	Preço
S18AD4117	1/2"	17	27	150	Azul	20.10€
S18AD4119	1/2"	19	28,5	150	Verde	20.10€
S18AD4121	1/2"	21	31	150	Vermelho	20.10€



Alicates

com revestimento antideslizante

P018 20.10€

Alicate universal
Comprimento: 200mm



P038 16.20€

Alicate de corte diagonal
Comprimento: 200mm



P046 13.60€

Alicate de corte
Comprimento: 160mm



P068 16.00€

Alicate de pontas
Comprimento: 200mm
Capacidade máxima: Ø3,0mm



P068A 15.20€

Alicate de pontas
Comprimento: 200mm



P079 21.20€

Alicate universal
Comprimento: 220mm
Capacidade máxima: Ø3,0mm



P6008 10.30€

Alicate regulável (2 posições)
Comprimento: 200mm



P61

Alicate de corte frontal

Ref.	Compr. (mm)	Preço
P6106	160	13.40€
P6108	200	16.00€

P9506 17.50€

Alicate corta fios
Comprimento: 165mm
Peso: 188g



Novo

P9512 41.20€

Alicate de pontas longas
Comprimento: 300mm



P27

Alicate ajustável

Ref.	Compr. (mm)	Preço
P2706	160	12.30€
P2710	250	18.70€
P2712	330	29.90€

P2810 19.20€

Alicate ajustável
Comprimento: 250mm



P266 11.70€

Alicate de freios internos e externos (pontas intermutáveis)

Capacidade: freios de 12 a 50mm
Pontas de: Ø1,2 e 1,5mm
Pontas direitas de: 45 e de 90°



AG010002S 54.60€

Jogo de 4 alicates de freios

Composição:
AG010002 Alicate de freios interiores com pontas direitas
AG010005 Alicate de freios interiores com pontas curvas
AG010008 Alicate de freios exteriores com pontas direitas
AG0100011 Alicate de freios exteriores com pontas curvas



AG01000

Alicate de freios interiores (pontas direitas)

Ref.	Compr. (mm)	Preço
AG010002	175	12.30€
AG010003	230	17.30€



AG01000

Alicate de freios interiores (pontas curvas)

Ref.	Compr. (mm)	Preço
AG010005	175	12.60€
AG010006	230	17.30€



AG01000

Alicate de freios exteriores (pontas direitas)

Ref.	Compr. (mm)	Preço
AG010008	175	11.90€
AG010009	230	16.70€





AG01000

Alicate de freios exteriores (pontas curvas 90°)

Ref.	Compr. (mm)	Preço
AG010011	175	11.90€
AG010012	230	17.30€

P9508C

21.10€

Alicate de freios interiores (pontas curvas)

Comprimento: 216mm
Capacidade: 10-32mm



P9508D

21.10€

Alicate de freios exteriores (pontas curvas)

Comprimento: 216mm
Capacidade: 10-32mm



P9902S

303.90€

Jogo de 2 alicate de freios

Composição:
P9920A Alicate de freios internos
P9920C Alicate de freios externos
Capacidade: 165-300mm



Novo

P9920-BT

13.90€

Pontas curvas (par)



Novo

P9920-ST

12.30€

Pontas direitas (par)



P7101

21.80€

Mini alicate de pontas curvas 45° (desenho ergonómico)

Comprimento: 140mm
Peso: 90g



P7102

20.60€

Mini alicate de corte frontal (desenho ergonómico)

Comprimento: 110mm
Peso: 90g



Alicates

com revestimento antideslizante e mola

P7103

18.60€

Mini alicate de corte diagonal (desenho ergonómico)

Comprimento: 115mm
Peso: 90g



P7104

18.90€

Mini alicate universal (desenho ergonómico)

Comprimento: 120mm
Peso: 90g



P7105

18.90€

Mini alicate de pontas direitas (desenho ergonómico)

Comprimento: 135mm
Peso: 90g



P8006

21.70€

Alicate universal

Comprimento: 160mm



P8106

20.20€

Alicate pontas longas

Comprimento: 160mm



P8606

21.50€

Alicate de corte diagonal

Comprimento: 160mm



P9006

21.50€

Alicate pontas chatas

Comprimento: 160mm



com revestimento antideslizante

Símbolo				
Tipo de material	Macio	Dureza média	Duro	Corda de piano
Exemplo	Cobre, alumínio	Ferro	Aço	Aço duro/ mola
Tensão N/mm ²	220-250	750-800	1700-1800	2200-2300

P051

Alicate corta cabos



Ref.	Compr. (mm)	mm ²	Ø mm	Preço
P0516	160	22	9.5	18.80€
P0518	200	38	11.5	22.00€

P0118

Alicate universal



Ref.	Compr. (mm)					Preço
P0118	200	5.0	3.5	2.4	2.0	21.10€

P081

Alicate universal



Ref.	Compr. (mm)					Preço
P0816	160	4.0	2.8	1.8	1.4	15.40€
P0817	180	4.0	3.0	2.0	1.6	16.40€
P0818	200	4.0	3.0	2.0	1.6	19.50€

P091

Alicate de corte (trabalho intensivo)



Ref.	Compr. (mm)					Preço
P0916	160	4.0	3.0	2.0	1.6	17.90€
P0917	180	5.0	3.5	2.4	2.0	19.20€
P0918	200	5.0	3.5	2.4	2.0	20.80€

P101

Alicate de corte



Ref.	Compr. (mm)					Preço
P1016	160	4.0	3.0	2.0	1.6	15.80€
P1017	180	4.0	3.0	2.0	1.6	18.30€

P111

Alicate de pontas



Ref.	Compr. (mm)					Preço
P1116	160	4.0	2.8	1.8	1.4	14.50€
P1118	200	4.0	3.0	2.0	1.6	17.30€

P121

Alicate de pontas curvas



Ref.	Compr. (mm)					Preço
P1216	160	4.0	2.8	1.8	1.4	16.10€
P1218	200	4.0	3.0	2.0	1.6	18.90€

P1416

Alicate de pontas chatas

Comprimento: 160mm



15.30€

P1516

Alicate de descarnar

Comprimento: 160mm



16.10€

P4016

Alicate de pontas redondas

Comprimento: 160mm



15.50€

P6118

Alicate de corte frontal



Ref.	Compr. (mm)	Preço
P6118	180	18.40€

Novo

P2811

Alicate ajustável



Ref.	Compr. (mm)	Preço
P28110	240	23.20€
P28112	300	32.30€

P2821

Alicate ajustável



Ref.	Compr. (mm)	Preço
P28210	240	29.30€
P28212	300	42.20€

P08104S
89.00€
Jogo de 4 alicates

Composição:

P0817 Alicate universal

P0917 Alicate de corte diagonal

P1118 Alicate de pontas direitas

P28210 Alicate de ajustável

PESD05
12.10€
Alicate anti-estático pontas curvas (com mola)

Comprimento: 150mm

PESD10
11.30€
Alicate anti-estático de corte (com mola)

Comprimento: 115mm

PESD11
11.70€
Alicate anti-estático de pontas (com mola)

Comprimento: 130mm

P178
17.60€
Turquês de carpinteiro

Comprimento: 200mm

P1810
17.00€
Turquês de cofragens

Comprimento: 250mm

P2010LA
15.30€
Tesoura articulada

Corte esquerda

Comprimento: 250mm

Peso: 395g

Capacidade de corte: Aço: 1,2mm | Aço inox: 0,7mm



Alicates

com revestimento antideslizante
P2010RA
14.80€
Tesoura articulada

Corte direita

Comprimento: 250mm

Peso: 395g

Capacidade de corte: Aço: 1,2mm | Aço inox: 0,7mm

P2010SA
15.60€
Tesoura articulada

Lâminas direitas

Comprimento: 200mm

P22
Tesoura de cortar chapa

Ref.	Compr. (mm)	Preço
P2208A	205	13.90€
P2212A	305	25.70€

P2205E
15.00€
Tesoura de electricista

P15808
16.20€
Tesoura multifunções

Lâminas em aço inox de 3mm

Comprimento: 206mm

P43
Alicate corta cabos

Ref.	Compr. (mm)	Peso	Capac. de corte	Preço
P4318	450	1 570g	fio 5mm cabo 10mm	48.20€
P4330	750	4 200g	fio 9mm cabo 14mm	91.40€

P4318-RK
22.30€
Kit de reparação
P4330-RK
45.10€
Kit de reparação

P6424 47.10€

Alicate corta cabos
Comprimento: 600mm
Peso: 2 700g
Capacidade de corte: Ø 10mm



P7601 24.00€

Alicate longo de pontas direitas
Comprimento: 275mm



P7602 24.00€

Alicate longo de pontas curvas 45°
Comprimento: 275mm



P7603 24.00€

Alicate longo de pontas curvas 90°
Comprimento: 275mm



P7608 24.50€

Alicate longo de pontas redondas Ø13mm
Comprimento: 275mm



P7719 42.00€

Alicate longo de torcer arame
Comprimento: 270mm
Peso: 360g
Capacidade: Ø 0,55mm



V1001 20.10€

Alicate de rebitar (trabalho intensivo)
Inclui 4 bicos: 2,4; 3,2; 4 e 4,8mm



V1002 65.70€

Alicate de rebitar extensível
Inclui 4 bicos: 2,4; 3,2; 4 e 4,8mm

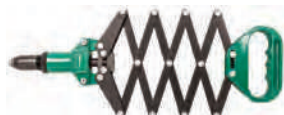

V1002-RK 2.30€

Kit de reparação para alicate de rebitar extensível V1002



V1003 52.40€

Alicate de rebitar (trabalho intensivo)
Inclui bicos: 6,4; 3,2; 4 e 4,8mm



V1003-RK 5.30€

Kit de reparação para alicate de rebitar V1003



V1005 29.00€

Alicate de rebitar (bicos intermutáveis)
Inclui bicos: 2,4; 3,2; 4 e 4,8mm



V21

Alicate de rebitar (bicos intermutáveis)

Ref.	Bicos (mm)	Preço
V2101	2,4; 3,2; 4 e 4,8 mm	39.70€
V2102	3,2; 4; 4,8 e 6,4 mm	52.90€

V2102-RK 5.80€

Kit de reparação para alicate de rebitar V2102



V1103 47.90€

Alicate de rebitar fêmeas
Capacidade: M3; M4; M5 e M6



V2401 74.10€

Alicate de rebitar fêmeas
Capacidade: M5; M6; M8 e M10



V2401

Mandril

Ref.	Medida	Preço
V2401-M5A	M5	3.80€
V2401-M6A	M6	3.80€
V2401-M8A	M8	3.80€
V2401-M10A	M10	4.00€



V2401

Bico



Ref.	Medida	Preço
V2401-M5B	M5	4.00€
V2401-M6B	M6	4.00€
V2401-M8B	M8	4.00€
V2401-M10B	M10	4.00€

AR030058

131.50€

Alicate de cravar terminais
Intermutável para 6 tipos de terminais



V1311

Alicate de cravar terminais



Ref.	Caraterísticas	Preço
V1311A	Terminais isolados	47.40€
V1311C	Fichas cabo coaxial	51.80€
V1311E	Terminais não isolados	46.80€
V1310F	Fichas RJ45	49.00€

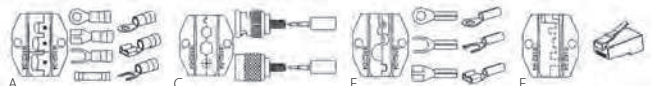

V1310

Accessórios para alicate de cravar V1310

Ref.	Terminais	Preço
V1310A-11	Mordentes	16.20€
V1310B-11	Mordentes	16.20€
V1310E-11	Mordentes	16.70€
V1310F-11	Mordentes RJ45	22.50€
V1310G-11	Mordentes AWG 22-10 (0,5-10mm ²)	22.50€
V1310J-11	Mordentes AWG 10-60 (6-16mm ²)	22.50€

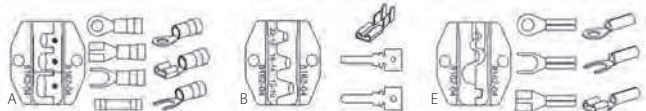

AR030022

86.80€

Jogo de 530 terminais auto com 18 tipos



Alicates

V1401

11.30€

Alicate de cravar terminais/ descarnar fios



V1403

21.70€

Alicate de cravar (trabalho intensivo)



V1501

27.30€

Alicate de descarnar (trabalho intensivo)

Parafuso de ajuste à espessura do fio

Comprimento: 172mm

Peso: 305g



V1505

21.20€

Alicate de descarnar



P30M10A

16.20€

Alicate de pressão bicos direitos

Comprimento: 250mm

Peso: 540g



P32M

Alicate de pressão bocas côncavas

Ref.	Compr. (mm)	Preço
P32M07A	180	13.10€
P32M10A	250	14.50€



P36M09A

14.30€

Alicate de pressão bicos longos

Comprimento: 230mm



P36M

Alicate de pressão tipo pistola

Ref.	Compr. (mm)	Preço
P36M01P	28	30.20€
P36M02P	48	30.20€



P37M

Alicate de pressão pescoço de cisne

Ref.	Compr. (mm)	Preço
P37M11A	280	24.60€
P37M18A	450	43.50€



P53M

Alicate pescoço cisne maxilas oscilantes

Ref.	Compr. (mm)	Preço
P53M06	152	15.90€
P53M11	280	28.40€
P53M18	460	44.90€



P38M

Alicate de pressão para soldadura

Ref.	Compr. (mm)	Preço
P38M09A	230	22.30€
P38M11A	280	26.20€



P54M

Alicate de pressão para latoeiros

Ref.	Compr. (mm)	Preço
P54M08A	205	18.80€
P54M10A	250	24.40€



P52A10

Alicate de pressão boca direita ajustável

Comprimento: 250mm

46.80€



P52B10

Alicate de pressão boca curva ajustável

Comprimento: 250mm

41.20€



P52C10

Alicate de pressão boca curva ajustável

Comprimento: 250mm

52.40€



P52D12

Alicate de pressão boca longa ajustável

Comprimento: 300mm

49.00€



P52M10

Alicate de pressão bocas recurvadas

Comprimento: 250mm

19.90€



P52N10

Alicate de pressão boca larga

Comprimento: 240mm

27.00€



P1019

Alicate de pressão com corrente

Comprimento: 230mm

Capacidade: 457mm

21.20€



P9409

Alicate de pressão

25.30€



P30M07C

Alicate de pressão isolado

Comprimento: 175mm

Peso: 360g

15.80€



P32M

Alicate de pressão isolado com mordentes curvos e corta fios

Ref.	Compr. (mm)	Peso (g)	Preço
P32M05C	125	175	13.70€
P32M10C	250	560	18.90€



P36M

Alicate de pressão isolado bicos longos com corta fios

Ref.	Compr. (mm)	Peso (g)	Preço
P36M06C	152	180	14.60€
P36M09C	270	560	17.10€



P78M10C

20.70€

Alicate de pressão isolado
Comprimento: 250mm



P32M03S

49.60€

Jogo de 3 alicates de pressão

Ref.	Caraterísticas	Compr. (mm)
P36M06S	Bicos longos	160
P32M07S	Bocas côncavas	180
P32M10S	Bocas côncavas	250



P7801

31.20€

Alicate de pressão multifunções
Garras tipo W



P7802

31.20€

Alicate de pressão multifunções
Garras tipo JJ



P7803

29.90€

Alicate de pressão multifunções
Garras tipo LL



P7804

29.70€

Alicate de pressão multifunções
Garras tipo J



P7805

33.20€

Alicate de pressão multifunções





D70S

Chaves fenda de impacto

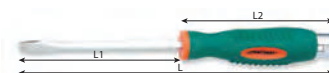

Ref.	Medida (mm)	L1 (mm)	L2 (mm)	L (mm)	Preço
D70S475	4	75	107	182	4.10€
D70S5100	5,5	100	107	207	5.30€
D70S6125	6,5	125	127	252	6.70€
D70S6150	6,5	150	127	277	7.00€
D70S8150	8	150	144	294	8.80€
D70S8175	8	175	144	319	8.90€
D70S9175	9,5	175	144	319	10.00€
D70S9250	9,5	250	144	394	11.50€

D70P

Chave phillips de impacto

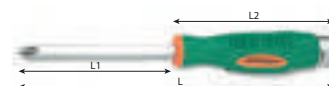

Ref.	Medida	L1 (mm)	L2 (mm)	L (mm)	Preço
D70P175	PH1	75	107	182	5.10€
D70P2100	PH2	100	127	277	6.10€
D70P3125	PH3	125	144	269	8.90€
D70P3150	PH3	150	144	299	9.20€

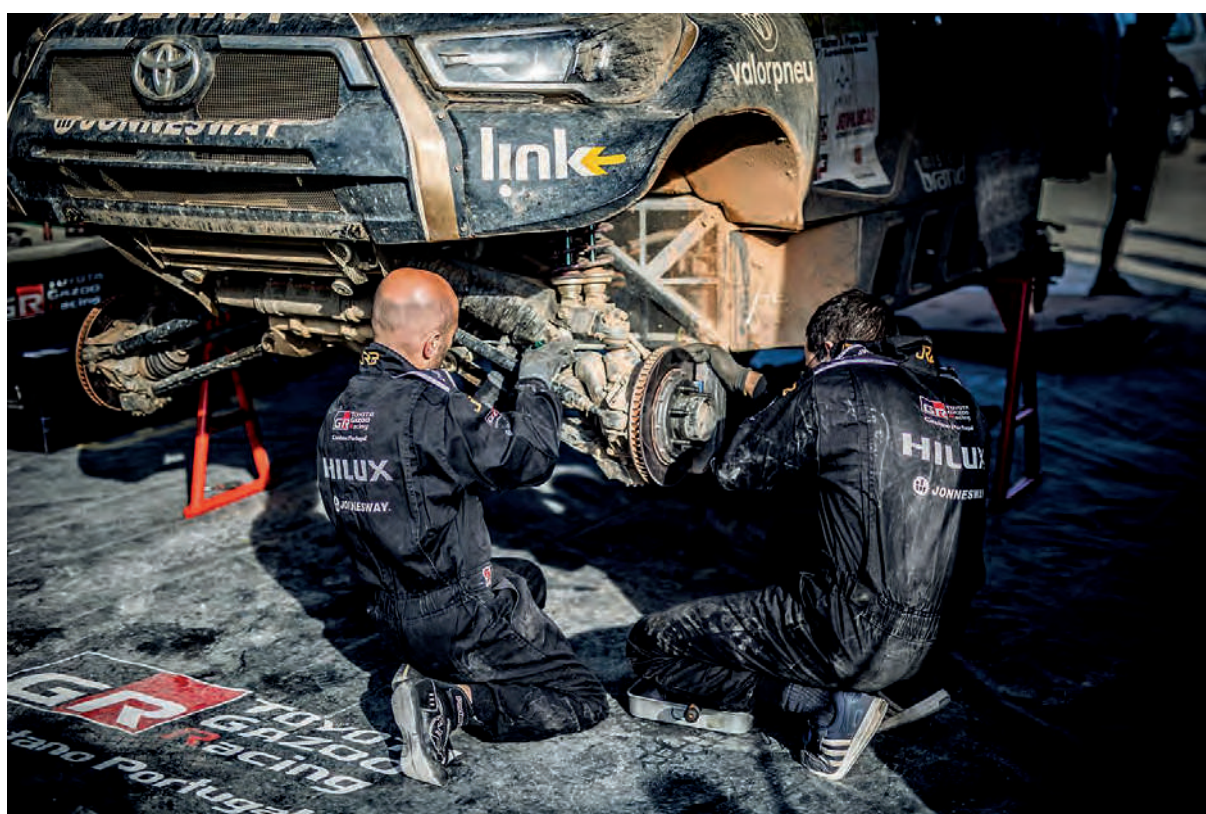

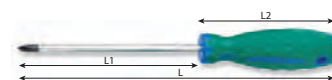
D71P
Chave phillips

Ref.	Medida	L1 (mm)	L2 (mm)	L (mm)	Preço
D71P060	PH0	60	90	150	3.00€
D71P138	PH1	38	56	94	2.90€
D71P180	PH1	80	110	190	3.30€
D71P238	PH2	38	56	94	2.90€
D71P1100	PH1	100	110	210	3.60€
D71P1150	PH1	150	110	250	3.90€
D71P1300	PH1	300	110	410	5.20€
D71P2100	PH2	100	119	219	4.00€
D71P2150	PH2	150	119	269	4.30€
D71P2250	PH2	250	119	369	6.70€
D71P2400	PH2	400	119	519	7.80€
D71P3150	PH3	150	129	279	6.00€
D71P3250	PH3	250	129	279	7.90€
D71P3400	PH3	400	129	529	10.30€
D71P4200	PH4	200	129	329	7.10€

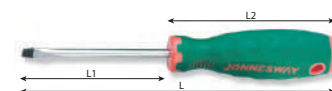
D71S
Chave fenda

Ref.	Medida (mm)	L1 (mm)	L2 (mm)	L (mm)	Preço
D71S250	2,4	50	72	122	2.60€
D71S360	3	60	72	132	2.80€
D71S4100	4	100	90	190	3.00€
D71S4150	4	150	110	260	3.80€
D71S4200	4	200	90	290	4.20€
D71S480	4	80	90	170	3.00€
D71S5125	5,5	125	110	235	3.50€
D71S5200	5,5	200	110	310	3.90€
D71S5300	5,5	300	110	410	5.40€
D71S538	5,5	38	56	94	2.80€
D71S575	5,5	75	110	185	3.30€
D71S638	6,5	38	56	94	2.80€
D71S6100	6,5	100	119	219	4.10€
D71S6150	6,5	150	119	269	4.50€
D71S6400	6,5	400	119	519	8.40€
D71S8150	8	150	129	279	5.80€
D71S8200	8	200	129	329	6.10€
D71S8300	8	300	129	429	8.20€
D71S8500	8	500	129	629	11.60€
D71S9175	9,5	175	129	304	6.40€
D71S10250	10	250			7.30€

Novo D04P

Chave phillips

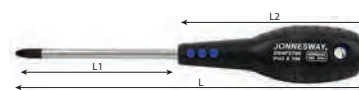

Ref.	Medida	L1 (mm)	L2 (mm)	L (mm)	Preço
D04P180	PH1	80		174	3.30€
D04P2100	PH2	100		221	4.00€
D04P3150	PH3	150		273	6.00€

Novo D04S

Chave fenda

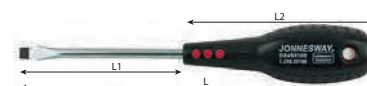

Ref.	Medida	L1 (mm)	L2 (mm)	L (mm)	Preço
D04S480	4	80		170	3.00€
D04S5125	5,5	125		220	3.50€
D04S6100	6,5	100		212	4.50€
D04S6150	6,5	150		260	4.50€



D71Z

Chave pozi

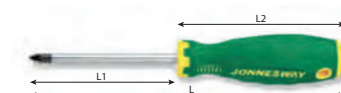

Ref.	Medida	L1 (mm)	L2 (mm)	L (mm)	Preço
D71Z060	PZ0	60	90	150	2.90€
D71Z138	PZ1	38	56	94	2.90€
D71Z180	PZ1	80	110	190	3.20€
D71Z2100	PZ2	100	119	219	4.10€
D71Z3150	PZ3	150	129	279	5.80€
D71Z4200	PZ4	200	129	329	7.20€

D71T

Chave torx

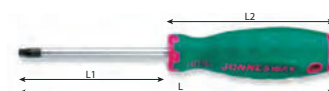

Ref.	Medida	L1 (mm)	L2 (mm)	L (mm)	Preço
D71T5	T5	60	73	132	2.60€
D71T6	T6	60	73	132	2.60€
D71T7	T7	60	73	132	2.60€
D71T8	T8	60	73	132	2.70€
D71T9	T9	60	73	132	2.70€
D71T10	T10	80	90	170	2.80€
D71T15	T15	80	90	170	2.80€
D71T20	T20	100	110	210	3.30€
D71T25	T25	100	110	210	3.30€
D71T27	T27	100	119	219	4.50€
D71T30	T30	125	119	244	4.70€
D71T40	T40	150	129	279	5.90€
D71T45	T45	200	129	329	6.40€
D71T50	T50	200	129	329	7.00€

D715N

Chave caixa com punho



Ref.	Medida	L1 (mm)	L2 (mm)	L (mm)	Preço
D715N05	5	125	119	244	5.90€
D715N07	7	125	119	244	6.00€
D715N08	8	125	119	244	6.00€
D715N10	10	125	119	244	6.70€
D715N12	12	125	119	244	6.70€
D715N13	13	125	119	244	7.20€

D70PP07S

53.50€

Jogo de 7 chaves fenda/ phillips de impacto

Composição/ medidas (mm):

3 Chaves fenda impacto: 5,5x100; 6,5x125 e 8x150

3 Chaves phillips: PH1x75; PH2x100 e PH3x125

1 Chave extensível com ponta magnética

D70PP10S

75.80€

Jogo de 10 chaves fenda/ phillips de impacto

Composição/ medidas (mm):

D70S Chaves fenda: 5,5x100; 6,5x125; 8x150; 9,5x175 e 6,5x38

D70P Chaves phillips: PH1x75; PH2x100; PH3x125 e PH2x38

Ponteiro magnético

D71400T
Chave torx longa

Ref.	Medida	Compr. (mm)	Preço
D71400T10	T10	400	6.90€
D71400T15	T15	400	7.50€
D71400T20	T20	400	8.10€
D71400T25	T25	400	8.70€
D71400T27	T27	400	9.60€
D71400T30	T30	400	10.50€

Novo
DV15PP-TP

4.30€

Busca-polos

220 - 250 v

Novo
AR030005

8.40€

Teste de circuito check-point

Chaves
D725N
Chaves "T" de punho antideslizante com caixa sextavada

Ref.	Medida (mm)	Compr. (mm)	Preço
D725N06	6	298	6.90€
D725N07	7	298	6.90€
D725N08	8	298	6.90€
D725N09	9	298	7.00€
D725N10	10	298	7.00€
D725N11	11	298	7.10€
D725N12	12	298	7.40€
D725N13	13	298	7.40€

D71C105S

20.10€

Jogo de 5 chaves fenda/ phillips

Composição/ medidas (mm):

Chaves fenda: 4x80; 5,5x125 e 6,5x150

Chaves phillips: PH1x80 e PH2x100

D71C106S

22.80€

Jogo de 6 chaves fenda/ phillips

Composição/ medidas (mm):

Chaves fenda: 3x60; 5,5x125 e 6,5x150

Chaves phillips: PH0x60; PH1x80 e PH2x100

D71PP08S

39.60€

Jogo de 8 chaves fenda/ phillips com punho antideslizante

Composição/ medidas (mm):

D71S Chaves fenda: 6,5x38; 4x80; 5,5x125 e 6,5x150

D71P Chaves phillips: PH2x38; PH1x80; PH2x100 e PH3x150

D71PP16S

86.40€

Jogo de 16 chaves fenda/ phillips com punho antideslizante

Composição/ medidas (mm):

D71S Chaves fenda: 6,5x38; 3x50; 6,5x100; 5,5x125; 5,5x200; 8,5x150; 5,5x75 e 4x150

D71P Chaves phillips: PH2x38; PH1x150; PH0x60; PH1x80; PH2x100; PH2x150; PH3x150 e PH1x38



D71T107S

30.10€

Jogo de 7 chaves torx com punho antideslizante

Composição/ medidas (mm):

Chaves: T10; T15; T20; T25; T27; T30 e T40



D71T109S

36.80€

Jogo de 9 chaves torx com punho antideslizante

Composição/ medidas (mm):

Chaves: T8; T9; T10; T15; T20; T25; T27; T30 e T40



D71Z105S

18.90€

Jogo de 5 chaves fenda/ pozi

Composição/ medidas (mm):

Chaves fenda: 4x80; 5,5x125 e 6,5x150

Chaves pozi: PZ1x80 e PZ2x100



D71Z107S

34.80€

Jogo de 7 chaves fenda/ pozi com punho antideslizante

Composição/ medidas (mm):

Chaves fenda: 4x100; 5,5x125; 6,5x150 e 8x175

Chaves pozi: PZ1x80; PZ2x100 e PZ3x150



D3750P08S

25.00€

Jogo de 8 chaves de precisão fenda/ phillips

Composição:

Ref.	Chave	Ponta (mm)	Compr. (mm)
D3750S30	fenda	3	50
D3750S24	fenda	2,4	50
D3750S20	fenda	2	50
D3750S16	fenda	1,6	50
D3750S10	fenda	1	50
D3750P1	phillips	nº1	50
D3750P0	phillips	nº0	50
D3750P00	phillips	nº00	50



D3750T08S

25.00€

Jogo de 8 chaves de precisão torx

Composição:

Ref.	Medida (mm)	Ref.	Medida (mm)
D3750T20	T20x50	D3750T8	T8x50
D3750T15	T15x50	D3750T7	T7x50
D3750T10	T10x50	D3750T6	T6x50
D3750T9	T9x50	D3750T5	T5x50



D3750P

Chave de precisão phillips



Ref.	Medida (mm)	Preço
D3750P0	PH0x50	2.20€
D3750P00	PH00x50	2.20€
D3750P1	PH1x50	2.20€

D3750S

Chave de precisão fenda



Ref.	Medida (mm)	Preço
D3750S10	1x50	2.20€
D3750S16	1,6x50	2.20€
D3750S20	2x50	2.20€
D3750S24	2,4x50	2.20€
D3750S30	3x50	2.20€

D3750T

Chave de precisão torx



Ref.	Medida (mm)	Preço
D3750T5	T5x50	2.20€
D3750T6	T6x50	2.20€
D3750T7	T7x50	2.20€
D3750T8	T8x50	2.20€
D3750T9	T9x50	2.20€
D3750T10	T10x50	2.20€
D3750T15	T15x50	2.20€
D3750T20	T20x50	2.20€

D3750T18S

24.00€

Jogo de 8 chaves de precisão

Composição:

Ref.	Medida (mm)	Ref.	Medida (mm)
D3750P00	P00x50	D3750T7	T7x50
D3750T4	T4x50	D3750A1	garfo 50
D3750T5	T5x50	D3750A2	inclinação 50
D3750T6	T6x50	D3750A3	agulha 50



DR0107S

16.40€

Jogo de bits longos e porta bits

Composição/ medidas (mm):

Porta bits
Bits duplo 65mm
Pozi 1/ fenda 5mm
Pozi 2/ fenda 6mm
Pozi 3/ fenda 7mm
Hexagonal 3mm/ 4mm
Hexagonal 5mm/ 6mm
Phillips/ fenda 6mm



DR0253S

60.20€

Jogo de bits e porta bits flexível

Composição/ medidas (mm):

Porta bits flexível
Bits phillips: #1; #2 e #3
Bits fenda: 3; 4; 5,5; e 7
Bits pozi: #0; #1; #2; e #3
Bits hexagonal: 2; 2,5; 3; 4; 5 e 6
Bits torx tamper proof: T8; T10; T15; T20; T25; T27; T20 e T40
Bits torx: T6; T8; T9; T10; T15; T20; T25; T27; T30 e T40
Adaptador 1/4" hexagonal
Adaptador magnético



DR0119S

16.40€

Novo

Jogo de porta bits com 18 bits

Composição:

Bits 25mm
2 Phillips: #1; #2
2 Pozi: #1; #2
6 Hexagonal: 2; 2,5; 3; 4; 5 e 6mm
6 Torx: T10; T15; T20; T25; T30 e T40



DR04

9.10€

Punho de 1/4" com roquete reversível

Comprimento total: 157mm



DBT31B

18.90€

Jogo de porta pontas de punho

Composição/ medidas (mm):

Porta pontas de punho
Pontas phillips
Pontas fenda
Pontas pozi
Pontas hexagonais
Pontas torx



DBT53A

63.50€

Jogo de 54 bits de 1/4" (cores)

Composição/ medidas (mm):

- Porta bits 1/4" 60mm
- 5x Bits pozi (azul) de 25mm
- 4x Bits pozi (azul) de 75mm
- 5x Bits fenda (laranja) 25mm
- 2x Bits fenda (laranja) 75mm
- 11x Bits torx (amarelo) 25mm
- 11x Bits torx (amarelo) 75mm
- 5x Bits phillips (vermelho) de 25mm
- 4x Bits phillips (vermelho) de 75mm
- 4x Bits hexagonais (laranja claro) 25mm
- 3x Bits hexagonais (laranja claro) 75mm



S08H208S

7.80€

Jogo de porta pontas angular (90°)

Composição:

- 7 Pontas 1/4"



S29H2133S

15.50€

Jogo de porta bits 1/4" com 33 peças

Composição:

- Porta bits magnético
- Bits torx
- Bits torx tamperproof
- Bits perfil "Tri Wing"
- Bits perfil "Spanner"
- Bits hexagonais



RD0638S

58.20€

Jogo de roquete com bits 1/4" com 38 peças

Composição:

- R3702 Roquete 48 dentes de 1/4"
- S04H2 10 Chaves de caixa 1/4" de 5; 6; 7; 8; 9; 10; 11; 12; 13 e 14mm
- D125FC 3 Bits fenda 4; 5 e 6mm (25mm laranja)
- D125PC 4 Bits philips PH1, PH2 x2 e PH3 (25mm vermelho)
- D125ZC 3 Bits pozi PZ1, PZ2 e PZ3 (25mm azul)
- D125HC 5 Bits hexagonal 3; 4; 5; 6 e 8mm (25mm laranja claro)
- D125TC 7 Bits torx T10, T15, T20, T25, T27, T30 e T40 (25mm amarelo)
- S44H2306 Porta bits hexagonal de 1/4"
- S24H250 Extensão de 1/4" de 50mm
- S24H2100 Extensão de 1/4" de 100mm
- S26H2150A Punho de 1/4"
- S15H240 Cardan de 1/4"



S29TP23S

35.60€

Jogo de bits Torx Plus de 1/4" com 23 peças

Composição:

- 5 Bits torx plus tamperproof de 1/4": TS10H; TS15H; TS20H; TS25H e TS30H
- 5 Bits torx plus tamperproof de 10mm: TS40H; TS45H; TS50H; TS55H e TS60H
- 5 Bits torx plus de 1/4": IP10H; IP15H; IP20H; IP25H e IP30H
- 5 Bits torx plus de 10mm: IP40H; IP45H; IP50H; IP55H e IP60H
- 1 Adaptador 3/8" x 10mm:
- 1 Adaptador 1/4" x 1/4"
- 1 Porta bits 1/4" x 1/4" com 60mm comprimento



RD01032S

39.90€

Jogo roquete com bits 1/4" com 32 peças

Composição:

- Roquete 1/4" de 60 dentes
- Porta bits magnético
- Bits phillips
- Bits hexagonais
- Bits quadrados
- Bits pozi
- Bits torx
- Bits fenda
- Bits torx tamperproof



RD05H2

16.70€

Chave de mão para bits

Quadra: 1/4"



AI020092

87.50€

Extrator de parafusos danificados

Jogo de brocas/ extrator e guias para remoção de parafusos danificados

Gama: 5 a 16mm



AN040082

141.50€

Jogo de extrator de fêmeas danificadas com 9 peças 3/8"

Medidas: 10; 11; 12; 13; 14; 15; 16; 17 e 19



S14A4

Chave para retirar fêmeas danificadas 1/2"

Ref.	Medida (mm)	Comp. (mm)	Preço
S14A4117	17		13.40€
S14A4118	18,5		13.40€
S14A4120	20	25	13.50€
S14A4121	21,5		13.50€
S14A4123	23	30	14.50€
S14A4124	24,5	30	14.50€
S14A4126	26	30	14.60€
S14A4127	27,5	33	14.80€

S14A4108S

117.50€

Jogo de 8 chaves para retirar fêmeas danificadas 1/2"

Composição/ medidas (mm):

Chaves: 17; 18,5; 20; 21,5; 23; 24,5; 26 e 27,5



as pontas bits são vendidas em embalagens de 10 unidades
os preços indicados são por unidade

D125H

Pontas/ bits de 1/4" hexagonais



Ref.	Medida (mm)	Compr. (mm)	Preço
D125H015A	1,5	25	0.40€
D125H020A	2	25	0.40€
D125H025A	2,5	25	0.40€
D125H030A	3	25	0.40€
D125H040A	4	25	0.40€
D125H050A	5	25	0.40€
D125H060A	6	25	0.40€
D125H070A	7	25	0.60€

D125T

Pontas/ bits de 1/4" torx



Ref.	Medida (mm)	Compr. (mm)	Preço
D125T06B	T6	25	0.30€
D125T08B	T8	25	0.30€
D125T10A	T10	25	0.40€
D125T15A	T15	25	0.40€
D125T20A	T20	25	0.40€
D125T25A	T25	25	0.40€
D125T27A	T27	25	0.40€
D125T30A	T30	25	0.40€
D125T40A	T40	25	0.40€

D125F

Pontas/ bits de 1/4" fenda



Ref.	Medida (mm)	Compr. (mm)	Preço
D125F4506A	0,6x4,5	25	0.40€
D125F6512A	1,2x6,5	25	0.40€
D125F8016A	1,6x8	25	0.60€

D125P

Pontas/ bits de 1/4" phillips



Ref.	Medida (mm)	Compr. (mm)	Preço
D125P1F	PH1	25	0.40€
D125P2F	PH2	25	0.40€
D125P3F	PH3	25	0.40€

D125Z

Pontas/ bits de 1/4" pozi



Ref.	Medida (mm)	Compr. (mm)	Preço
D125Z1A	PZ1	25	0.40€
D125Z2A	PZ2	25	0.40€
D125Z3A	PZ3	25	0.40€

D130H

Pontas/ bits de 10mm hexagonais



Ref.	Medida (mm)	Compr. (mm)	Preço
D130H40	4	30	1.10€
D130H50	5	30	1.10€
D130H60	6	30	1.10€
D130H70	7	30	1.10€
D130H80	8	30	1.10€
D130H100	10	30	1.10€
D130H120	12	30	1.20€

D130T

Pontas/ bits de 10mm torx



Ref.	Medida (mm)	Compr. (mm)	Preço
D130T20	T20	30	1.00€
D130T25	T25	30	1.10€
D130T30	T30	30	1.10€
D130T40	T40	30	1.10€
D130T45	T45	30	1.10€
D130T50	T50	30	1.10€
D130T55	T55	30	1.10€

D150F

Pontas/ bits de 1/4" fenda



Ref.	Medida (mm)	Compr. (mm)	Preço
D150F5510A	1x5,5	50	0.60€
D150F6512A	1,2x6,5	50	0.60€
D150F8012A	1,2x8	50	0.80€



D150P

Pontas/ bits de 1/4" phillips

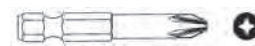

Ref.	Medida (mm)	Compr. (mm)	Preço
D150P1A	PH1	50	0.60€
D150P2A	PH2	50	0.60€
D150P3A	PH3	50	0.60€

D150Z

Pontas/ bits de 1/4" pozi



Ref.	Medida (mm)	Compr. (mm)	Preço
D150Z1A	PZ1	50	0.60€
D150Z2A	PZ2	50	0.60€
D150Z3A	PZ3	50	0.60€

D150H



Pontas/ bits de 1/4" hexagonais

Ref.	Medida (mm)	Compr. (mm)	Preço
D150H030A	3	50	0.60€
D150H040A	4	50	0.60€
D150H050A	5	50	0.60€
D150H060B	6	50	0.60€
D150H070B	7	50	0.70€
D150H080B	8	50	0.80€

D150T



Pontas/ bits de 1/4" torx

Ref.	Medida (mm)	Compr. (mm)	Preço
D150T20A	T20	50	0.60€
D150T25A	T25	50	0.60€
D150T27A	T27	50	0.60€
D150T30A	T30	50	0.60€
D150T40A	T40	50	0.60€

D100MN



Ponta hexagonal magnética de 1/4" para fêmeas

Ref.	Medida (mm)	Compr. (mm)	Preço
D100MN08M	8	100	3.70€
D100MN10M	10	100	4.50€
D100MN12M	12	100	4.70€
D100MN13M	13	100	4.60€
D100MN14M	14	100	4.90€

D100N



Ponta hexagonal de 1/4" para fêmeas

Ref.	Medida (mm)	Compr. (mm)	Preço
D100N13M	13	100	3.60€

Novo

D10M3



Pontas/ bits de 10mm estriado XZN

Ref.	Medida (mm)	Compr. (mm)	Preço
D10M30M05A	M5	30	1.00€
D10M30M06A	M6	30	1.00€
D10M30M08A	M8	30	1.00€
D10M30M10A	M10	30	1.00€
D10M30M12A	M12	30	1.20€
D10M30M14A	M14	30	1.30€

D10M7



Pontas/ bits de 10mm estriado XZN

Ref.	Medida (mm)	Compr. (mm)	Preço
D10M75M05A	M5	75	1.60€
D10M75M06A	M6	75	1.70€
D10M75M08A	M8	75	1.70€
D10M75M10A	M10	75	1.80€
D10M75M12A	M12	75	2.00€
D10M75M14A	M14	75	2.20€

D175H



Pontas/ bits de 10mm hexagonais

Ref.	Medida (mm)	Compr. (mm)	Preço
D175H40	4	75	1.70€
D175H50	5	75	1.70€
D175H60	6	75	1.70€
D175H70	7	75	1.70€
D175H80	8	75	1.70€
D175H100	10	75	1.80€
D175H120	12	75	2.10€

D175T



Pontas/ bits de 10mm torx longo

Ref.	Medida (mm)	Compr. (mm)	Preço
D175T20	T20	75	1.80€
D175T25	T25	75	1.80€
D175T30	T30	75	1.80€
D175T40	T40	75	1.80€
D175T45	T45	75	1.80€
D175T50	T50	75	1.80€
D175T55	T55	75	1.80€

D125TT



Pontas/ bits de 1/4" torx tamper proof

Ref.	Medida (mm)	Compr. (mm)	Preço
D125TT08A	T8	25	0.50€
D125TT10A	T10	25	0.50€
D125TT15A	T15	25	0.50€
D125TT20A	T20	25	0.50€
D125TT25A	T25	25	0.50€
D125TT27A	T27	25	0.50€
D125TT30A	T30	25	0.50€
D125TT35A	T35	25	0.50€
D125TT40A	T40	25	0.50€

Chaves

D150MH

Porta pontas/ bits magnético para bits de 1/4"

Ref.	Medida (mm)	Compr. (mm)	Preço
D150MH1AD	10	50	2.40€



D150MH

Porta bits magnético p/bit 1/4" c/bloqueio

Ref.	Medida (mm)	Compr. (mm)	Preço
D150MH1QD	10,5	50	5.80€
D160MH1QD	10,5	60	5.90€



Novo

D165MN

Ponta hexagonal magnética de 1/4" para fêmeas

Ref.	Medida (mm)	Compr. (mm)	Preço
D165MN06M	6	65	2.50€
D165MN07M	7	65	2.50€
D165MN08M	8	65	2.60€
D165MN10M	10	65	3.40€
D165MN12M	12	65	3.90€
D165MN13M	13	65	4.10€



S29H2180S

42.60€

Conjunto de 180 pontas

Composição:

phillips
pozi
hexagonais
torx



H01MH118S

50.00€

Jogo de 18 chaves hexagonais curtas

Composição/ medidas (mm):

Chaves: 1,5; 2; 2,5; 3; 3,5;
4; 4,5; 5; 5,5; 6; 7; 8; 9; 10;
12; 14; 17 e 19



H01SA109S

12.80€

Jogo de 9 chaves hexagonais curtas

Sistema especial antideslizante

Composição/ medidas (mm):

Chaves: 1,5; 2; 2,5; 3;
4; 5; 6; 8 e 10



JONNESWAY

H01B

Chave hexagonal curta

Ref.	Medida (mm)	Preço
H01B1015	1,5	0.10€
H01B1020	2	0.10€
H01B1025	2,5	0.20€
H01B1030	3	0.30€
H01B1035	3,5	0.40€
H01B1040	4	0.60€
H01B1045	4,5	0.70€
H01B1050	5	0.70€
H01B1055	5,5	0.80€
H01B1060	6	0.90€
H01B1070	7	1.10€
H01B1080	8	1.30€
H01B1090	9	1.80€
H01B1100	10	2.10€
H01B1120	12	4.00€
H01B1140	14	5.60€
H01B1160	16	7.60€
H01B1170	17	8.40€
H01B1180	18	10.60€
H01B1190	19	12.80€
H01B1220	22	18.60€



H01SM109S

13.10€

Jogo de 9 chaves hexagonais curtas

Composição/ medidas (mm):

Chaves: 1,5; 2; 2,5; 3;
4; 5; 6; 8 e 10



H02MH217S

71.50€

Jogo de 17 chaves hexagonais longas SAE

Composição/ medidas:

Chaves: 1/16"; 5/64"; 3/32";
7/64"; 1/8"; 9/64"; 5/32"; 3/16";
1/4"; 5/16"; 3/8"; 7/16";
1/2"; 9/16"; 5/8" e 3/4"



H02SM109S

16.40€

Jogo de 9 chaves hexagonais longas

Composição/ medidas (mm):

Chaves: 1,5; 2; 2,5; 3; 4;
5; 6; 8 e 10



H02SM209S

16.40€

Jogo de 9 chaves hexagonais longas SAE

Composição/ medidas:

Chaves: 1/16"; 5/64";
3/32"; 1/8"; 5/32";
3/16"; 1/4"; 5/16" e 3/8"



H01SA

Chaves hexagonais curtas antideslizante

Ref.	Medida (mm)	L1 (mm)	L2 (mm)	Preço
H01SA115	1,5	46,5	15,5	0.50€
H01SA120	2	52	18	0.50€
H01SA125	2,5	58,5	20,5	0.60€
H01SA130	3	66	23	0.80€
H01SA140	4	74	29	1.10€
H01SA150	5	85	33	1.30€
H01SA160	6	96	38	1.80€
H01SA180	8	108	44	1.80€
H01SA1100	10	122	50	3.10€

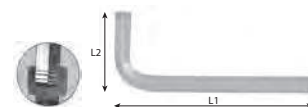
H06SA

Chaves hexagonais extra longas com ponta esférica antideslizante

Ref.	Medida	L1 (mm)	L2 (mm)	Preço
H06SA115	1,5	91,5	15,5	0.70€
H06SA120	2	102	18	0.70€
H06SA125	2,5	114,5	20,5	0.70€
H06SA130	3	129	23	1.00€
H06SA140	4	144	29	1.30€
H06SA150	5	165	33	1.60€
H06SA160	6	186	38	2.30€
H06SA180	8	208	44	3.00€
H06SA1100	10	234	50	4.10€

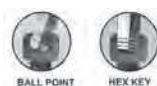
H12S

Chaves torx extra longa

Ref.	Medida	L1 (mm)	L2 (mm)	Preço
H12S09085	T9	85	5	1.40€
H12S10090	T10	90	5,5	1.40€
H12S15100	T15	100	8	1.50€
H12S20115	T20	115	12,5	1.70€
H12S25130	T25	130	18	1.70€
H12S27145	T27	145	24,5	2.00€
H12S30165	T30	165	40	2.30€
H12S40185	T40	185	62	2.80€
H12S45205	T45	205	98	3.20€
H12S50230	T50	230	128	4.50€

H20MT

Chaves torx dupla de punho

Ref.	Medida	L1 (mm)	L2 (mm)	Preço
H20MT10	T10	110	15	4.00€
H20MT15	T15	120	15	4.00€
H20MT20	T20	125	16	4.60€
H20MT25	T25	135	16	4.90€
H20MT27	T27	145	16	5.00€
H20MT30	T30	155	16	5.60€
H20MT40	T40	165	16	5.90€
H20MT45	T45	185	16	6.70€
H20MT50	T50	205	20	8.00€



H03MH118S 79.70€

Jogo de 18 chaves hexagonais extra longas

Composição/ medidas (mm):

Chaves: 1,5; 2; 2,5; 3; 3,5; 4;
4,5; 5; 5,5; 6; 7; 8; 9;
10; 12; 14; 17 e 19



H03SM109S 18.10€

Jogo de 9 chaves hexagonais extra longas

Composição/ medidas (mm):

Chaves: 1,5; 2; 2,5;
3; 4; 5; 6; 8 e 10



H06SA109S 18.40€

Jogo de 9 chaves hexagonais macho extra longas com ponta esférica antideslizante



H06SM209S 19.90€

Jogo de 9 chaves hexagonais com ponta esférica SAE

Composição/ medidas (mm):

Chaves: 1/16"; 5/64";
3/32"; 1/8"; 5/32"; 3/16";
1/4"; 5/16" e 3/8"



H03SS109S 21.20€

Jogo de 9 chaves macho hexagonais de baixo perfil

Composição/ medidas (mm):

Chaves: 1,5; 2; 2,5;
3; 4; 5; 6; 8 e 10



H05SS109S 20.60€

Jogo de 9 chaves macho hexagonais com ponta esférica de baixo perfil

Composição/ medidas (mm):

Chaves: 1,5; 2; 2,5; 3;
4; 5; 6; 8 e 10 mm



H05SA109S 17.00€

Jogo de 9 chaves hexagonais longas com ponta esférica antideslizante

Composição/ medidas (mm):

Chaves: 1,5; 2; 2,5; 3;
4; 5; 6; 8 e 10



H06ST108S 22.30€ Novo

Conjunto de 8 chaves hexagonais longas com ponta esférica

Composição/ medidas (mm):

Chaves: 2; 2,5; 3;
4; 5; 6; 8 e 10 mm



H06SM

Chave hexagonal longa de ponta esférica SAE

Ref.	Medida	Preço
H06SM170	7	2.80€
H06SM225	3/32"	0.90€
H06SM230	1/8"	1.10€
H06SM240	5/32"	1.40€
H06SM250	3/16"	1.80€
H06SM255	7/32"	2.00€
H06SM260	1/4"	2.10€
H06SM280	5/16"	3.20€
H06SM2100	3/8"	4.50€

H06W106S 73.50€

Jogo de 6 chaves articuladas hexagonais de ponta redonda

Composição/ medidas (mm):

Chaves: 3; 4; 5; 6; 8 e 10



H07M09S 15.50€

Jogo de 9 chaves torx

Composição/ medidas (mm):

Chaves: T10; T15; T20; T25;
T27; T30; T40; T45 e T50



H07MT

Chave torx em L

Ref.	Medida	Preço
H07MT10	T10	1.00€
H07MT15	T15	1.10€
H07MT20	T20	1.20€
H07MT25	T25	1.30€
H07MT27	T27	1.40€
H07MT30	T30	1.50€
H07MT40	T40	1.80€
H07MT45	T45	2.10€
H07MT50	T50	2.70€

H0816S

29.00€

Jogo de 16 chaves macho com ponta torx

Composição/ medidas (mm):

 Chaves: T6; T7; T8; T9; T10; T15;
T20; T25; T27; T30; T40; T45;
T50; T55; T60 e T70

H08MTP09S

16.70€

Jogo de 9 chaves torx tamperproof

Composição/ medidas (mm):

 Chaves: T10; T15; T20; T25;
T27; T30; T40; T45 e T50

H08S110S

26.20€

Jogo de 10 chaves torx longas tamperproof

Composição/ medidas (mm):

 Chaves: T9; T10; T15; T20;
T25; T27; T30; T40; T45 e T50

H08ST

Chaves torx longas tamperproof

Ref.	Medida	Compr. (mm)	Preço
H08ST09085	T9	80	1.70€
H08ST10090	T10	90	1.70€
H08ST15100	T15	100	1.80€
H08ST20115	T20	112	1.90€
H08ST25130	T25	126	1.90€
H08ST27145	T27	142	2.00€
H08ST30165	T30	160	2.50€
H08ST40185	T40	180	2.80€
H08ST45205	T45	200	3.50€
H08ST50230	T50	224	4.70€

H10MB08S

42.10€

Jogo de 8 chaves hexagonais duplas de punho

Composição/ medidas (mm):

 Chaves: 2x100; 2,5x100;
3x100; 4x100; 5x150; 6x150;
8x200 e 10x200

Chaves

H10MB
Chave hexagonal dupla de punho com ponta esférica

Ref.	Medida	Preço
H10MB2100	2x100	3.30€
H10MB25100	2,5x100	3.30€
H10MB3100	3x100	3.50€
H10MB4100	4x100	3.60€
H10MB5150	5x150	4.00€
H10MB6150	6x150	4.30€
H10MB8200	8x200	6.50€
H10MB10200	10x200	8.40€

H10MT09S

50.00€

Jogo de 9 chaves duplas torx tamperproof com punho

Composição/ medidas (mm):

 Chaves: T10x100; T15x100;
T20x100; T25x100; T27x150;
T30x150; T40x150; T45x200
e T50x200

H10MT
Chave dupla de punho torx tamperproof

Ref.	Medida	Preço
H10MT10100	T10x100	3.30€
H10MT15100	T15x100	3.70€
H10MT20100	T20x100	3.70€
H10MT25100	T25x100	3.80€
H10MT27150	T27x150	3.80€
H10MT30150	T30x150	4.30€
H10MT40150	T40x150	4.70€
H10MT45200	T45x200	7.00€
H10MT50200	T50x200	7.50€

H12S110S

25.10€

Jogo de 10 chaves torx longas

Composição/ medidas (mm):

 Chaves: T9; T10;
T15; T20; T25; T27;
T30; T40; T45 e T50

H15M105S

19.70€

Jogo de 5 chaves estriadas em "L"

Composição/ medidas (mm):

Chaves: M5; M6; M8; M10 e M12



H20MB1037S

72.00€

Jogo de 9 chaves hexagonais de ponta esférica com punho e 28 bits

Composição/ medidas (mm):

H20MB

Chaves: H1,5X100; H2X100; H2,5X110; H3X120;

H4X125; H5X155; H6X165; H8X185 e H10X210

Bits phillips: PH1; PH2 e PH3

Bits pozi: PZ1; PZ2 e PZ3

Bits torx: T10; T15; T20; T25; T27; T30; T35 e T40

Bits fenda: 3; 4; 5; 6 e 7

Bits estriados: M4; M5 e M6

Bits quadrados: 1; 2 e 3

Bits spanner: 4 e 6



H20MT09S

68.00€

Jogo de 9 chaves torx duplas de punho

Composição/ medidas (mm):

Chaves: T10x110; T15x120; T20x125; T25x135; T27x145; T30x155; T40x165; T45x185 e T50x205

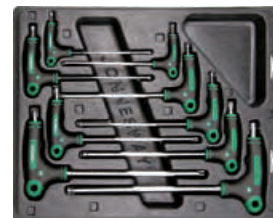

H22S109S

24.00€

Jogo de 9 chaves hexagonais extra longas estriadas

Especial para remover parafusos danificados

Composição/ medidas (mm):

Chaves: 1,5; 2; 2,5; 3; 4; 5; 6; 8 e 10

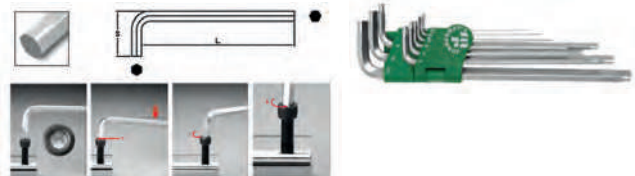

M03025

32.90€

Marreta metálica

Peso: 1 330g

M040
Martelo com batente redondo e pena esférica

Ref.	Peso (g)	Compr. (mm)	Preço
M04008	395	278	13.90€
M04012	527	283	14.60€
M04016	780	327	17.30€
M04024	1 063	383	23.40€
M04032	1 208	385	25.10€

M010
Martelo de orelhas em aço

Ref.	Peso (g)	Compr. (mm)	Preço
M01016	777	320	32.30€
M01020	875	350	35.10€

M05020

20.90€

Martelo de orelhas

Peso: 830g

Comprimento: 330mm

M060
Marreta

Ref.	Peso (g)	Compr. (mm)	Preço
M06030	1 550	263	23.40€
M06040	2 250	276	26.70€

M07016

21.20€

Martelo de batentes plásticos

Peso: 840g

Comprimento: 314mm

M07016-ACE

3.30€

Batente amarelo de substituição M07016

M07016-TPR

2.00€

Batente preto de substituição M07016

Martelos

M29
Martelo de batentes plásticos intermutáveis

Ref.	Diâmetro (mm)	Compr. (mm)	Preço
M2932	32	290	27.30€

M2927
Batentes para martelo M2927

Ref.	Cor	Preço
M2927-T1	branco	3.20€
M2927-T2	amarelo	4.30€

M2932
Batentes para martelo M2932

Ref.	Cor	Preço
M2932-T1	branco	3.50€
M2932-T2	amarelo	4.00€

M2940
Batentes para martelo M2940

Ref.	Cor	Preço
M2940-T2	amarelo	7.20€

M2950
Batentes para martelo M2950

Ref.	Cor	Preço
M2950-T1	branco	6.60€
M2950-T2	amarelo	9.80€

M09
Martelo de mecânico tipo "alemão"

Ref.	Peso (g)	Compr. (mm)	Preço
M09100	100	260	9.50€
M09200	200	280	10.60€
M09300	300	300	12.60€
M09500	500	320	17.60€
M09800	800	350	20.60€
M091000	1 000	360	25.40€

M110
Martelo anti recuo revestido a borracha

Ref.	Peso (g)	Compr. (mm)	Preço
M11035	400	260	17.90€
M11045	520	286	21.70€
M11065	1500	370	37.30€



M601

Punção de bico



Ref.	D (mm)	D1 (mm)	L (mm)	Preço
M60103	3	9,5	120	2.10€
M60104	4	9,5	120	2.60€
M60105	5	12	120	3.50€

M611

Talhadeira



Ref.	D (mm)	D1 (mm)	L (mm)	Preço
M61110	10	9,5	150	3.00€
M61112	12	9,5	130	3.00€
M61113	13	9,5	150	3.40€
M61116	16	12,7	180	4.20€
M61119	19	15,8	180	5.90€
M61122	22	15,8	200	6.70€
M61125	25	19	200	9.50€



M621

Punção



Ref.	D (mm)	D1 (mm)	L (mm)	Preço
M62102	2	9,5	120	2.30€
M62103	3	9,5	120	2.30€
M62104	4	9,5	120	2.30€
M62105	5	9,5	120	2.30€
M62106	6	9,5	120	2.30€
M62108	8	9,5	120	2.40€

M631

Saca troços



Ref.	D (mm)	D1 (mm)	L (mm)	Preço
M63102	2	8	115	2.60€
M63103	3	8	125	2.70€
M63104	4	9,5	150	3.10€
M63105	5	9,5	165	3.50€
M63106	6	12,7	180	4.00€
M63108	8	12,7	180	4.10€

M641

Buril



Ref.	D (mm)	D1 (mm)	L (mm)	Preço
M64105	5	9,5	130	3.80€

M63106S

20.60€

Jogo de 6 saca troços

Composição/ medidas (mm):

 2x8x115; 3x8x125;
 4x9,5x150; 5x9,5x165;
 6x12,7x180 e 8x12,7x180

M63M106S

22.70€

Jogo de 6 saca troços cromados

Composição/ medidas (mm):

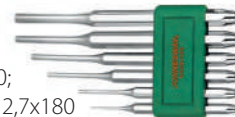
 2x8x115; 3x8x125; 4x9,5x150;
 5x9,5x165; 6x12,7x180 e 8x12,7x180

M64105S

15.00€

Jogo de 5 punções e escopros

Composição/ medidas (mm):

 Punção: 2x8x115; 3x8x125;
 4x9,5x150; 5x9,5x165; 6x12,7x180
 Escopro: 8x12,7x180

M64M105S

17.10€

Jogo de 5 punções e escopros cromados

Composição/ medidas (mm):

 Punção: 3x 9,5x120
 Punção bico: 2x9,5x120
 Talhadeira: 12x9,5x130
 Saca troços: 4x9,5x150
 Escopro: 5x9,5x130

M61H1

Escopro com punho de proteção



Ref.	Medida (mm)	Compr. (mm)	Preço
M61H116	16	170	6.50€
M61H119	19	190	7.80€
M61H124	24	220	11.70€

M62H1

Punção com punho de proteção



Ref.	Medida (mm)	Compr. (mm)	Preço
M62H102	2	185	5.50€
M62H103	3	185	5.50€
M62H104	4	185	5.50€
M62H106	6	185	5.50€

Punções e Escopros

M63H1

Saca troços com punho de proteção



Ref.	Medida (mm)	Compr. (mm)	Preço
M63H103	3	150	4.30€
M63H105	5	200	5.70€
M63H106	6	210	7.70€
M63H108	8	220	7.80€

M64A155

18.00€

Novo

Punção manual com regulação de força

AI030045

147.80€

Jogo de 4 cinzeis com proteção



MF05

Limas

Ref.	Tipo	Medida (mm)	Preço
MF05A	chata	200	9.70€
MF05B	redonda	200	8.40€
MF05C	meia cana	200	10.00€
MF05D	quadrada	200	9.70€
MF05E	triangular	200	9.20€

MF05S

55.70€

Jogo de 5 limas de 200mm

Composição:

MF05A	Lima chata
MF05B	Lima redonda
MF05C	Lima meia cana
MF05D	Lima quadrada
MF05E	Lima triangular



MF06S

28.40€

Jogo de 6 mini limas de 100mm

Composição:

- Mini lima redonda
- Mini lima triangular
- Mini lima quadrada
- Mini lima meia cana
- Mini lima plana
- Mini lima plana em bico



MHS100AG

24.00€

Serra



MHS300

21.20€

Serra multi ângulos

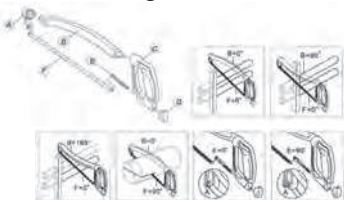

P9601

13.70€

Navalha corta cabos



MK2040

11.40€

X-ato com lâmina retrátil
Com 2 lâminas de substituição



MK2040-B

1.70€

Lâmina para x-ato MK2040 - 5 unidades

MK2080

12.30€

X-ato

Botão de segurança lâmina
Inclui 4 lâminas 18x100mm



MKS27

24.70€

Jogo de x-ato

Composição:

- X-ato
- Raspador
- Acessórios



MKS27

Lâmina raspador - 100 unidades

Ref.	Tipo	Medida (mm)	Preço
MKS27-12	A	12	23.00€
MKS27-16	B	16	25.50€
MKS27-16A	C	(53°) 16	26.70€
MKS27-20	D	20	21.70€



MT09

Fita métrica

Corpo em plástico ABS resistente ao choque

Ref.	Compr. (m)	Preço
MT0901	3	4.50€
MT0902	5	7.20€



Novo

AG010023

15.10€

Base para lixa em plástico ABS

Dimensões: 106x212mm



MTC

Paquímetro digital

Ref.	Compr. (mm)	Preço
MTC150	150	73.60€
MTC200	200	121.50€



MTC1

Paquímetro leitura vigesimal

Ref.	Compr. (mm)	Preço
MTC1150	150	50.60€
MTC1200	200	83.30€
MTC1300	300	115.30€



MTC153

Esquadro metálico

Dimensões: 300x40x1mm

18.90€



Novo

MTC155

Caneta de gravação e marcação de metal, ponta tungstênio

13.90€



MTC156

Régua metálica

Dimensões: 334x23,7x1mm

3.30€



MTC3

Compasso de precisão pontas direitas

Ref.	Compr. (mm)	Preço
MTC306	150	21.20€
MTC308	200	23.50€



MTC408

Compasso de precisão pontas curvas para exteriores

Comprimento: 200mm

22.50€



MTC508

Compasso de precisão pontas curvas para interiores

Comprimento: 200mm

22.30€



MTM1

Micrómetro exteriores

Ref.	Medida (mm)	Preço
MTM1025	0-25	41.20€
MTM1050	25-50	46.20€
MTM1075	50-75	50.60€
MTM1100	75-100	56.10€



DV13P

Chave phillips isolada (1000 Volts)

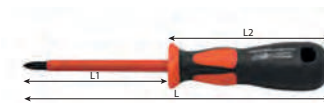

Ref.	Medida	L1 (mm)	L2 (mm)	L (mm)	Preço
DV13P060	PH0	60	98	158	4.10€
DV13P180	PH1	80	104	184	4.90€
DV13P2100	PH2	100	110	210	5.60€
DV13P3150	PH3	150	120	270	7.20€

DV13S

Chave fenda isolada (1000 Volts)

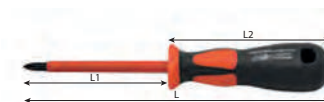

Ref.	Medida (mm)	L1 (mm)	L2 (mm)	L (mm)	Preço
DV13S275	2,5	75	98	173	4.50€
DV13S3100	3x100	100	80	180	4.80€
DV13S4100	4	100	98	198	5.00€
DV13S5125	5,5	125	104	229	5.30€
DV13S6150	6,5	150	110	260	6.60€
DV13S8175	8x175	175	120	295	7.60€

DV13Z

Chave pozi isolada (1000 Volts)



Ref.	Medida (mm)	L1 (mm)	L2 (mm)	L (mm)	Preço
DV13Z060	PZ0x60	60	98	158	4.30€
DV13Z180	PZ1x80	80	104	184	5.30€
DV13Z2100	PZ2x100	100	110	210	5.80€
DV13Z3150	PZ3x150	150	120	270	7.50€

S43V

Cabo "T" com isolamento a 1 000V



Ref.	Quadra	Compr. (mm)	Peso (g)	Preço
S43V38	3/8"	200	240	40.70€
S43V48	1/2"	250	330	43.50€

RV03

Roquete com isolamento a 1 000V



Ref.	Quadra	Compr. (mm)	Peso (g)	Preço
RV032	1/4"	150	140	46.20€
RV033	3/8"	200	300	55.70€
RV034	1/2"	250	570	64.60€

DV13PP07S

54.00€

Jogo de chaves isoladas fenda/ phillips (1000 Volts)

Composição/ medidas (mm):

 Chaves fenda: 4x100; 5,5x125 e 6,5x150
 Chaves phillips: PH0x60; PH1x80 e PH2x100
 Busca-polos

DV41M
Chaves de caixa isoladas com punho (1000 Volts)

Ref.	Medida	Compr. (mm)	Preço
DV41M5	M5	125	7.90€
DV41M6	M6	125	7.90€
DV41M7	M7	125	7.90€
DV41M8	M8	125	8.00€
DV41M10	M10	125	8.10€
DV41M13	M13	125	9.20€

DV4118SV

192.50€

Tabuleiro EVA com ferramentas isoladas (1000 volts)

Composição:

Ref.	Chave	Medida (mm)
DV13S275	fenda	2,5x75
DV13S3100	fenda	3x100
DV13S4100	fenda	4x100
DV13S5125	fenda	5,5x125
DV13P060	phillips	PH0x60
DV13P180	phillips	PH1x80
DV13P2100	phillips	PH2x100
DV13P3150	phillips	PH3x150
DV41M	caixa punho	M4x125; M5x125; M5,5x125; M6x125; M7x125; M8x125; M9x125; M10x125; M11x125 e M12x125

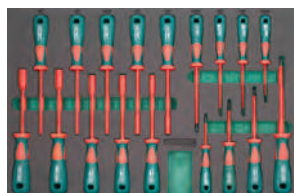
DV41M06S

58.30€

Jogo de 6 chaves de caixa isoladas com punho (1000 Volts)

Composição/ medidas:

Chaves caixa: M5; M6; M7; M8; M10 e M13

DV15109S

40.10€

Bolsa de 7 chaves isoladas (fenda/phillips)

MKV7

12.90€

X-ato isolado 1000V

Comprimento: 180mm

Lâmina: 50mm

MKV7-K

18.40€

Lâmina para x-ato isolado 1000 volts - 4 unidades

MKV8

21.70€

Navalha isolada 1000V

Comprimento: 180 mm

Lâmina: 50mm

PV0118

27.30€

Alicate universal

Cumpre a norma IEC 60900

Compr. (mm)	○	◐	◑	●
200	4.0	3.0	2.0	1.6

PV08
Alicate universal isolado (1000 volts)

Cumpre a norma IEC 60900

Ref.	Compr. (mm)	○	◐	◑	●	Preço
PV0816	160	4.0	3.0	2.0	1.6	20.70€
PV0817	180	4.0	3.0	2.0	1.6	22.80€





PV0518 31.20€

Alicate corta cabos (trabalho intensivo)

Cumpra a norma IEC 60900

Comprimento: 200mm
Capacidade de corte: Ø13/60mm



PV0918 26.40€

Alicate de corte

Cumpra a norma IEC 60900

Compr. (mm)				
200	4.0	3.0	2.0	1.6



PV1016 22.10€

Alicate de corte diagonal

Cumpra a norma IEC 60900

Compr. (mm)				
160	4.0	3.0	2.0	1.6



PV1116 21.50€

Alicate de pontas redondas isolado (1000 volts)

Cumpra a norma IEC 60900

Comprimento: 160mm



PV1118 22.80€

Alicate de pontas

Cumpra a norma IEC 60900

Compr. (mm)				
200	4.0	3.0	2.0	1.6



PV1218 24.00€

Alicate de pontas redondas

Cumpra a norma IEC 60900

Compr. (mm)				
200	4.0	3.0	2.0	1.6



PV1416 21.00€

Alicate de pontas chatas

Cumpra a norma IEC 60900

Comprimento: 160mm



PV1516 21.20€

Alicate de descarnar fios (trabalho intensivo)

Cumpra a norma IEC 60900

Comprimento: 160mm



PV28110 29.50€

Alicate ajustável

Cumpra a norma IEC 60900

Comprimento: 275mm



PV4006 26.70€

Alicate de pontas redondas

Cumpra a norma IEC 60900

Comprimento: 200mm



PSV218SP 114.80€

Jogo de ferramentas isoladas 1 000V

Composição/ medidas em mm:

- 2 Chaves phillips isoladas: PH1x80; PH2x100
- 2 Chaves fenda isoladas: 5x125; 6x150
- 1 Alicate de corte diagonal
- 1 Alicate de universal
- 1 Alicate de pontas
- 1 Busca polos

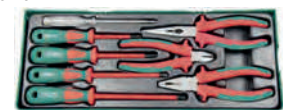

PSV110SC 181.60€

Jogo de 10 ferramentas isoladas 1 000V

Composição:

- 4 Alicates
- 4 Chaves de fenda/ phillips
- 1 Navalha
- 1 Busca-polos

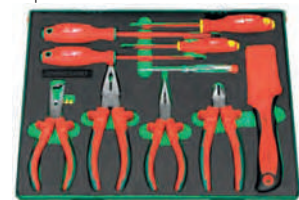

S03V21

Chaves de caixa 1/4" com isolamento a 1 000V



Ref.	Medida (mm)	Compr. (mm)	Preço
S03V2106	6	41	5.70€
S03V2108	8	41	5.70€
S03V2110	10	41	5.70€
S03V2114	14	41	6.70€

S03V31

Chaves de caixa 3/8" com isolamento a 1 000V

Ref.	Medida (mm)	Compr. (mm)	Preço
S03V3108	8	44,5	7.80€
S03V3110	10	44,5	7.80€
S03V3112	12	44,5	8.00€
S03V3113	13	44,5	8.20€
S03V3114	14	44,5	8.50€
S03V3117	17	44,5	9.10€
S03V3119	19	46	9.70€
S03V3122	22	46	11.10€

S03V41

Chaves de caixa 1/2" com isolamento a 1 000V

Ref.	Medida (mm)	Compr. (mm)	Preço
S03V4110	10	55	9.10€
S03V4111	11	55	9.50€
S03V4112	12	55	9.70€
S03V4113	13	55	9.70€
S03V4114	14	55	10.30€
S03V4117	17	55	10.40€
S03V4119	19	57	10.50€
S03V4122	22	57	12.30€
S03V4124	24	57	12.80€
S03V4127	27	59	14.50€
S03V4132	32	59	17.80€

S03V3116SC

278.60€

Jogo de 16 peças 3/8" com roquete isolado a 1 000V



Composição/ medidas em mm:

RV033	Roquete isolado 200
S43V38	Cabo "T" 200
S25V36	Extensão 150
S25V310	Extensão 250
S03V3	Chaves de caixa: 8; 10; 12; 13; 14; 17; 19 e 22
S09V3	Bits: 4; 5; 6 e 8

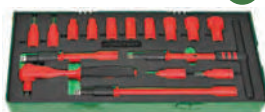
S03V4120SC

395.60€

Jogo de 20 peças 1/2" com roquete isolado a 1 000V

Composição/ medidas em mm:

RV034	Roquete isolado 250
S43V48	Cabo "T" 200
S25V45	Extensão 125
S25V410	Extensão 250
S03V4	Chaves de caixa: 10; 11; 12; 13; 14; 17; 19; 22; 24; 27 e 32
S09V4	Bits: 4; 5; 6; 8 e 10



Ferramenta isolada a 1 000V
S03V3136SV

518.10€

Tabuleiro EVA com ferramentas de 1/4" e 3/8" isoladas a 1 000V

Composição/ medidas em mm:

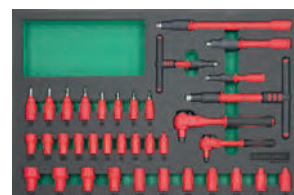
RV032	Roquete de 1/4"
RV033	Roquete de 3/8"
S43V28	Cabo "T" de 1/4" de 125
S43V38	Cabo "T" de 3/8" de 200
S25V24	Extensão de 1/4" de 100
S25V3	Extensão de 3/8" de 150 e 250
S03V21	10 Chaves de caixa: 5 a 14
S03V31	11 Chaves de caixa: 8 a 22
S09V2H	4 Bits de caixa de 1/4" de 60
S09V3H	4 Bits de caixa de 3/8" de 60



S03V4124SV

462.40€

Tabuleiro EVA com ferramentas 1/2" isoladas a 1 000V

Composição/ medidas em mm:

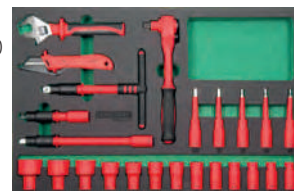
RV034	Roquete de 1/2"
S43V48	Cabo "T" de 1/2" de 200
S25V4	Extensão de 125 e 250
S03V41	13 Chaves de caixa: 10 a 32
S09V41H	5 Bits de caixa de 200
WV27AS8	Chave inglesa de 150
MKV7	X-acto

S09V3H

Chaves de caixa hexagonal 3/8" com isolamento a 1 000V

Ref.	Medida (mm)	Compr. (mm)	Preço
S09V3H4	4	60	8.20€
S09V3H5	5	60	8.20€
S09V3H6	6	60	8.50€
S09V3H8	8	60	9.50€

S09V41H

Chaves de caixa 3/8" com isolamento a 1 000V

Ref.	Medida (mm)	Compr. (mm)	Preço
S09V41H4	4	120	11.60€
S09V41H5	5	120	11.60€
S09V41H6	6	120	11.60€
S09V41H8	8	120	11.60€
S09V41H10	10	120	12.80€

Ferramenta isolada a 1 000V

S25V3



Extensão 3/8" com isolamento a 1 000V

Ref.	Compr. (mm)	Peso (g)	Preço
S25V36	150	150	27.90€
S25V310	250	250	33.40€

S25V4



Extensão 1/2" com isolamento a 1 000V

Ref.	Compr. (mm)	Peso (g)	Preço
S25V45	150	210	31.20€
S25V410	250	410	34.50€

W23V1



Chaves luneta com isolamento a 1 000V

Ref.	Medida (mm)	Compr. (mm)	Preço
W23V108	8	164	21.20€
W23V110	10	174	21.80€
W23V111	11	184	22.70€
W23V112	12	184	22.70€
W23V113	13	205	25.10€
W23V114	14	205	25.10€
W23V116	16	221	27.90€
W23V117	17	221	28.40€
W23V118	18	237	32.30€
W23V119	19	237	32.30€
W23V121	21	257	35.70€
W23V122	22	257	35.70€
W23V124	24	287	41.80€



JONNESWAY

W25V1



Chaves de boca 3/8" com isolamento a 1 000V

Ref.	Medida (mm)	Compr. (mm)	Preço
W25V108	8	104	15.00€
W25V109	9	104	15.60€
W25V110	10	114	16.20€
W25V113	13	154	17.50€
W25V114	14	154	17.80€
W25V117	17	170	19.50€
W25V118	18	180	22.30€
W25V119	19	180	22.30€
W25V121	21	202	27.90€
W25V122	22	202	27.90€
W25V124	24	237	29.50€

W25V1125SV

624.00€

Tabuleiro EVA com ferramentas isoladas a 1 000V

Composição/ medidas em mm:

W23V11	9 Chaves luneta 10 a 19mm
W25V	13 Chaves bocas 7 a 24mm
PV0818	Alicate universal 200mm
PV1016	Alicate de corte 160mm
PV1116	Alicate de pontas 160mm



WV27AS10

58.50€

Chave ajustável isolada 1000V

Abertura: 33mm
Comprimento: 200mm





JONNESWAY®

**Ferramenta Especial
Mecânica**



Mecânica



Chapeiro



Motociclos



Pesados

Ferramenta específica - ramo automóvel

AB030056 44.60€

Insuflador de ar para abertura de portas

Comprimento: 230mm



AB030061 27.60€

Ferramenta para retirar braço do limpa parabrisas



AE040020 75.80€

Cilindro hidráulico

Comprimento: 140mm fechado | 215mm estendido

Capacidade: 2t



Novo **AE040038** 46.80€

Chave para fêmeas retenção cilindros hidráulicos



AE150005 128.10€

Par de preguiças de 3t com apoio em borracha

Altura máxima: 440mm

Altura mínima: 290mm



AE3000

Adaptadores para teste radiadores

Ref.	Preço
AE300064-02	22.80€
AE300064-03	22.80€
AE300064-04	23.40€
AE300064-05	23.70€
AE300064-06	18.40€
AE300064-07	18.40€
AE300064-15	27.60€
AE300064-16	27.60€



AE300064 287.40€

Kit teste de pressão para radiadores com 17 peças

Composição:

AE300064-02 Audi A4, A5, A6

AE300064-03 Opel, Ford, VW

AE300064-04 BMW

AE300064-05 BMW

AE300064-06 Volvo, Citroën, Renault, Fiat, Peugeot

AE300064-07 Audi, VW

AE300064-08 Sede ajustável

AE300064-09 Pino união 50mm

AE300064-10 Pino união 35mm

AE300064-11 Pino união 27mm

AE300064-12 Adaptador para 8; 9 e 11

AE300064-13 Adaptador

AE300064-14 Fixador

AE300064-15 Honda, Toyota

AE300064-16 Mitsubishi, Honda, Ford, Nissan, Mazda

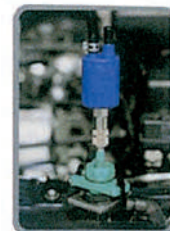

AE300100-040 25.70€

Adaptador para kit de pressão de radiadores - Ford

Aplicável no kit AE300064



AE300100-042 25.70€

Adaptador para kit de pressão de radiadores - Ford

Aplicável no kit AE300064



AE300100-060 27.40€

Adaptador para kit de pressão de radiadores - Mercedes

Aplicável no kit AE300064



AE300103 22.00€

Aparadeira de chão para óleo

Dimensões: 600x450x180mm

Capacidade: 16l



AE300152

222.90€

Kit teste de pressão do radiador com 5 peças



AE300173

22.70€

Sangrador de fluido de embraiagem e travões
Fácil, rápido e eficiente utilizando o ar dos pneus



AE300176-A

49.00€

3 Adaptadores especiais para VW/ Audi/ Mercedes



AE300212

135.00€

Distribuidor de óleo de transmissões

Dimensões: 240x200x440mm
Capacidade: 4l
Peso: 1 600g
Bomba manual e 4 adaptadores



AE310002

324.40€

Conjunto de saca hidráulico com acessórios

Capacidade: 90-145mm



AE310002-RK

31.20€

Novo

Kit de reparação para AE310002



AE310006

117.00€

Conjunto de 2 extratores

Capacidade: 30-75mm



AE3100

Separadores meia lua

Ref.	Medida (mm)	Preço
AE310024	30-50	24.00€
AE310025	50-75	36.80€
AE310026	75-105	57.90€
AE310027	105-150	128.10€



AE310008

185.00€

Extrator interior e exterior

Capacidade: 15-30 e 30-80mm interna
15-80mm externa



AE310010A

143.00€

Jogo de extrator semieixo



Novo

AE310012

258.50€

Jogo de extrator interno para rolamentos cegos c/martelo deslizante



AE310016

66.30€

Extrator semieixo



AN010045

12.10€

Separador de rótulas



AE310023

54.60€

Extrator de rótulas



AE310062

68.90€

Saca rolamentos longo

Comprimento: 300mm
Capacidade: 10-50mm



AE310063

85.60€

Saca para pequenos rolamentos

Especialmente indicado para remoção de pequenos rolamentos na área automóvel, reparação de equipamentos industriais e domésticos

Capacidade: 1t

Abertura: 19 a 45mm

Profundidade alcance: 73mm



AE310066

29.90€

Extrator para volantes de direção

Aplicável: Opel, Ford entre outros



AE310073

34.00€

Extrator de rótulas

Abertura: 20mm



AE310077

43.40€

Extrator de rótulas

Abertura: 20mm



AE310087

94.70€

Extrator universal de rótulas

Especialmente concebido para situações de utilização em espaço reduzido

Aplicável: Audi, VW, BMW, Ford, Mercedes

(W170, W202, W210, W220), Opel, Mitsubishi ...



AE310099

133.70€

Extrator 7" de 2 ou 3 pernas para interiores e exteriores

Capacidade: 20t

Abertura: 76-178mm



Alterável para:



AE3100

Saca de 3 pernas



Ref.	Tamanho	Abertura (mm)	Capacidade (t)	Preço
AE310034	3"	40-76	2	22.00€
AE310035	4"	50-102	5	30.60€
AE310037	8"	80-203	12	123.20€
AE310038	12"	120-305	18	261.90€

AE3101

Extrator de rótulas



Ref.	Ø (mm)	Largura (mm)	Altura (mm)	Preço
AE310109A	18	40	35	21.70€
AE310110	23	50	45	47.40€
AE310112	40	80	80	94.70€

AE3101

Saca de 2 braços



Ref.	Ajuste Int. (mm)	Ajuste Ext. (mm)	Altura (mm)	Preço
AE310146B	25-80	70-130	100	66.90€
AE310146D	50-160	105-220	150	111.40€
AE310146E	60-200	120-270	150	144.90€
AE310146G	80-350	160-420	200	347.70€
AE310146H	110-520	195-600	200	503.70€

JR72
TOYOTA CAETANO

AE310122

104.70€

Extrator de rótulas
Abertura: 32mm



Novo

AE310135

103.50€

Saca de 2 braços



AE310150

94.70€

Saca polies



AE310172

936.00€

Jogo de sacas

Composição:

Saca de 2ton

Pernas curtas: 85mm

Pernas compridas: 185mm

Saca de 6ton

Pernas curtas: 140mm

Pernas compridas: 280mm

Cilindro de 30ton



Novo

AE310172-1

90.30€

Separador meia lua p/saca AE310172



AE310180

312.00€

Jogo de saca rótulas com acessórios ajustáveis

Abertura: 20; 22; 24; 27 e 30mm



AE310183

144.90€

Removedor da barra de direção



AE320023

44.60€

Compressor de molas para amortecedores

Abertura: 270mm



AE320034

638.00€

Jogo de extrator de molas MacPherson

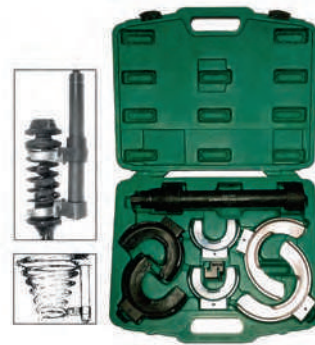

AE320044

84.50€

Compressor de molas para amortecedores

Abertura: 300mm



AE300154B

137.10€

Refratômetro

Aparelho apto para testar líquido de baterias, líquido refrigerante e AdBlue



AE300168

114.80€

Verificador de fugas da cabeça do cilindro

Equipamento destinado a verificar fugas na combustão. A utilização de líquido contrastante permite verificar a existência de dióxido de carbono no depósito do líquido de refrigeração, denunciando assim a existência de fugas na combustão.



AE300168-1

47.40€

Líquido para verificador da cabeça do cilindro

Embalagem de 250ml

AI020074

167.10€

Detector de fugas para cilindros



AE300201

144.90€

Pistola tornado vaporizadora

Dimensões: 330x105x270mm
Capacidade copo: 1l
Peso: 780g
Ruído: 85dB
Alimentação: 6,2bar
Consumo de ar: 56,6l/min
Entrada de ar: 1/4"



AE300202

139.30€

Pistola tornado vaporizadora/ espuma

Dimensões: 330x105x260mm
Capacidade copo: 1l
Peso: 950g
Ruído: 70dB
Alimentação: 6,2bar
Entrada de ar: 1/4"
Consumo de ar: 56,6l/min



AE300204

26.40€

Seringa para fluidos

Fabricado em plástico resistente a fluido travões e anticongelante. Permite sucção, adição e visualização do fluido

Capacidade: 200cc
Peso: 294g

**NÃO
utilizar com
combustíveis**



AE300205

57.60€

Seringa para fluidos

Fabricado em plástico resistente a fluido travões e anticongelante. Permite sucção, adição e visualização do fluido

Capacidade: 1,5l
Peso: 900g

Aplicação: óleo da caixa velocidades e diferenciais

**NÃO
utilizar com
combustíveis**



AE300211

105.90€

Seringa para fluidos com 5 adaptadores

Fabricado em plástico resistente e aplicável a todos os tipos de óleos e combustíveis. Permite sucção, adição e visualização do fluido.

Capacidade: 1,5l



AE300206

17.70€

Base de recolha de óleos para latas 20/ 30l

Concebido para recolha de restos de óleo de filtros, novo ou usado, e outros recipientes (encaixe direto em latas de 20/ 30l)
Fabricado em polietileno resistente de alta densidade

Capacidade: 3l
Peso: 500g
Diâmetro: 350mm



AE300207

60.20€

Base de recolha de óleos para bidons 200l

Concebido para recolha de restos de óleo de filtros, novo ou usado, e outros recipientes (encaixe direto no topo de bidons de 200l)
Fabricado em polietileno resistente de alta densidade

Capacidade: 20l
Peso: 1 700g
Diâmetro: 600mm

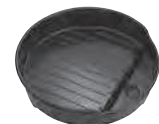

AE300215

42.30€

Pistola de limpeza de motores

Bico ajustável
Capacidade: 1l
Consumo de ar: 160 l/m
Entrada de ar: 1/4"
Pressão de trabalho: 5-8 Bar



AE300220

91.40€

Escorredor de resíduos de óleo

Dimensões: 174x197x486mm
Capacidade: 2l



AG010034

7.00€

Caneta magnética

Comprimento: 580mm



AG010035

29.00€

Pesca magnético com luz e espelho



AG010163A

9.70€

Pesca magnético flexível



AG010164

44.60€

Kit de pesca magnético com luz e espelho

Luz: branca, azul e UV



AG010036

9.90€

Bandeja magnética redonda

Dimensões: Ø 150mm



AG010111

32.90€

Bandeja magnética retangular

Dimensões: 240x140mm



AG010046

11.90€

Ponteira para válvulas dos pneus

Comprimento: 230mm



AG010049

11.00€

Jogo de 5 saca pernos



AG010059

36.20€

Jogo de 4 saca casquilhos

Medidas: 6; 8; 10 e 12mm



AG010059

Saca casquilhos

Ref.	Medida (mm)	Preço
AG010059-6	6	7.90€
AG010059-8	8	7.90€
AG010059-10	10	8.90€
AG010059-12	12	8.00€

AG010089

18.90€

Medidor digital de pressão de ar

Baterias de lítio
Visor LCD
Auto calibração
Auto off



AG010159
8.20€
Ponteira para mangueira de ar dos pneus

Ponteira: 6mm

AG010207
93.60€
Gambiarra de Leds

Inclui: Carregador 220v AC/ 5v DC e cabo USB

Dimensões: 375x30x30mm

Potência: 15W

Carregador: 220v/ 50Hz

Capacidade da bateria: 2,5 a 10h

Fluxo luminoso: 410 lumen

Tempo de carga: 3,5 a 4h

Iluminância máxima: 935 lux projetada a 50cm

Bateria recarregável: Li-ion 3,7v 2 200mAh

AG010224
80.20€
Gambiarra flexível de Leds

Comprimento: 168mm

Bateria: Li-ion 3,7v - 2.2Ah

Carregador: AC/DC

Haste flexível 360°

Base magnética

Regulador de intensidade

Autonomia: 2 a 8h (variável conforme intensidade)

AS-0065
44.50€
Suporte magnético para máquina de impacto e 4 chaves

C-DM1
27.60€
Barra magnética

Dimensões: 475x52x17mm

AG010099
39.10€
Chaves de cruz para porcas de rodas

Medidas: 17; 19 e 21mm

AG010225
33.40€
Chave de rodas com 3 peças

Pode ser utilizado em + ou em "T"

Medidas: 17; 19 e 21mm

Tubo perfurado 355mm com chave de 19 e 21mm

Tubo perfurado 395mm com chave de 17mm

Adaptador 1/2"

AG01016
Chave de rodas dupla

Ref.	Medida (mm)	Dimensão (mm)	Preço
AG010167	24x27	3/4" x 600	49.00€
AG010168	30x32	3/4" x 600	55.70€
AG010169	32x33	3/4" x 600	57.90€

AG010109
23.40€
Quebra porcas

Medidas: 12-18 e 16-22mm

AG010118A
27.90€
Medidor angular de torque 1/2"

AG010147
15.00€
Chave de aperto angular de torque 1/2"

AG10001SP-G
4.80€
Medidor de passo de rosca

AG010208

63.50€

Jogo de extratores de parafusos torx danificados com 8 peças

Composição:

Medida (mm)	Compr. (mm)	Hex (mm)
3	38	10
4	38	10
5	38	10
6	38	10
7	38	12
8	38	12
10	38	14
12	38	14



AG010227

356.60€

Jogo de machos e caçonetos com 53 peças

Composição:

- 15 Machos 38mm: M6x0,75; M6x1,0; M8x1,0; M8x1,25; M10x1,25; M10x1,5; M12x1,25; M12x1,5; M12x1,75; M14x1,5; M14x2,0; M16x1,5; M16x2,0; M18x1,5 e M18x2,5
- 6 Machos 50mm: M20x1,5; M20x2,5; M22x1,6; M22x2,5; M24x1,5 e M24x3,0
- 21 Caçonetos: M6x0,75; M6x1,0; M8x1,0; M8x1,25; M10x1,25; M10x1,5; M12x1,25; M12x1,5; M12x1,75; M14x1,5; M14x2,0; M16x1,5; M16x2,0; M18x1,5; M18x2,5; M20x1,5; M20x2,5; M22x1,5; M22x2,5; M24x1,5 e M24x3,0

5 Extratores

1 Porta caçonetos

1 Desandador de machos (M6 - M25)

1 Desandador de machos (M4 - M12)

1 Chave phillips PH2 38mm

2 Adaptadores de Ø 50mm



AG010229

168.50€

Jogo de machos e caçonetos com 50 peças

Composição:

- 22 Machos + 22 Caçonetos: M3x0,5; M3x0,6; M4x0,7; M4x0,75; M5x0,8; M5x0,9; M6x0,75; M6x1,0; M7x0,75; M7x1,0; M8x1,0; M8x1,25; M9x1,0; M9x1,25; M10x1,0; M10x1,25; M10x1,5; M11x1,5; M12x1,25; M12x1,5; M12x1,75 e 1/8NPT27

1 Desandador de machos M6 - M12

1 Desandador em "T" para machos

1 Porta caçonetos

1 Chave phillips

1 Medidor passo rosca

1 Punção



AG10001SP-T

4.00€

Desandador em T para machos



AG10001SP-D

8.60€

Porta caçonetos



AG10001SP-W

9.90€

Desandador macho extensível

Medidas: M4 a M12



AG10002SC-W

6.70€

Desandador macho extensível

Medidas: M3 a M12



AH020002

27.10€

Proteção de guarda-lamas com fixação magnética

Dimensões: 1 050x650mm



AI010006

31.20€

Ferramenta para bloqueio de polias e carretos

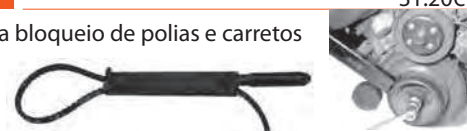

AI010009

28.70€

Ferramenta para limpeza das ranhuras de segmentos

Com 3 lâminas circulares para limpeza de pistões (diâmetro: 51 a 127mm)

Lâmina 1: 1/16"; 5/64"; 3/32"; 1/8"; 5/32" e 3/16"

Lâmina 2: 2; 2,5; 3; 4; 4,5mm e 1/4"

Lâmina 3: 1,2; 1,5; 1,8; 2,8; 5 e 5,5mm

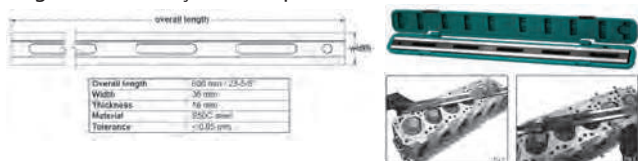

AI010017
167.10€
Régua de verificação de empenos do motor

AI010023
15.80€
Esticador de correias

AI010029
83.60€
Saca carretos e polias

AI010030
111.40€
Chave bloqueio da polie da árvore de cames

AI010060
77.20€
Jogo de 4 chaves para injetores 1/2"

Composição:

	Faces	Diâmetro (mm)	Medida (mm)
A	6	22	110
B	12	22	75
C	12	27	78
D	12	28	78

AI010060-A
21.50€
Chaves para injetores 1/2"

 Faces: 6
 Diâmetro: 22mm
 Medida: 110mm

AI010037
108.10€
Kit comando de motores com 8 peças

Composição:

Marca	Modelo	Aplicação
OPEL	Astra	G 1.7 TD; 2.0 16V
	Vectra	1.8; 2.0 16V >1995
OPEL	Astra	G 1.4 ; 1.6; 1.8 16V
	Vectra	1.6; 1.8 16V
	Zafira	1.6; 1.8 16V

Árvore de cames à direita

SAAB	900 - 9000	
OPEL	Calibra	2.5; 2.5L; 2.6 V6
	Cavalier	2.5L V6 2.5; 2.5L; 2.6 V6
	Omega-B	2.5; 2.6; 3.0; 3.2; V6
	Sintra	3.0 V6
	Vectra	2.5L; 2.6 V6

Árvore de cames à esquerda

SAAB	900 - 9000	
OPEL	Calibra	2.5; 2.5L; 2.6 V6
	Cavalier	2.5L V6 2.5; 2.5L; 2.6 V6
	Omega-B	2.5; 2.6; 3.0; 3.2; V6
	Sintra	3.0 V6
	Vectra	2.5L; 2.6 V6

ROVER

25	1.4; 1.6; 1.8VVC
45	1.4; 1.6; 1.8
75	1.8
200	VI
214	1.6V
216	1.6V; Cabrio; Coupé
218	Coupé
414	1.6V
416	1.6V; BRM 1.8VVC

VOLKSWAGEN

Bora	1.9 TDI
Golf	1.9 TDI
Lupo	1.2; 1.4; 3.0 TDI
Polo	1.4 TDI
Passat	1.9 TFI

CITROËN

Berlingo	1.9 D
Jumper	1.9 D; TD-FSO 1.9D;
Jumpy	1.9 D/TD
Synergie	1.9; 2.0 T
Xantia	1.9; 2.0 D; TD; HDI
Xsara	1.9; 2.0 D; TD; HDI

FIAT

Ducato	2.0 D
Ulysse	1.8; 2.0 Turbo

FORD

Maioria dos Motores Diesel	
----------------------------	--

PEUGEOT

205	1.6; 1.8; 1.9 D
305	1.6; 1.8; 1.9 D
306	1.8; 1.9 D; TD
309	1.6; 1.9 D
405	1.6; 1.9 D
406	1.9 D
605	2.0 D; TD
806	1.9 D
Boxer	1.9; 2.0 D; TD
Expert	1.9 D
Partner	1.9 D

TALBOT

Express	D
Horizon	D-J5D
Solara	D

ISUZU

Motores Diesel	1.5; 1.7
----------------	----------

OPEL

Motores Diesel	1.6; 1.7
Motores Gasolina	1.2; 1.4; 1.6; 1.8; 2.0

AI010041

125.90€

Kit comando de motores com 19 peças

Composição:

Marca	Modelo	Motorização	
CITROËN	Synergie	2.0/Turbo; ZX 1.9D/TD	
	Xantia	1.9D/TD	
	Berlingo	1.9D	
FIAT	Ulisses	2.0/Turbo	
	Ducato	2.0	
FORD	Fiesta	1.25; 1.4 (95-); 1.8-XR2i/RS1800 16V	
	Mondeo	1.6; 1.8; 2.0 16V (93-)	
	Escort/Orion	1.6; 1.8i 16V (92-)	
HONDA	Accord/Prelude	2.3i (93-);	
	Prelude	2.2 V-Tec; motor SOHC	
	Accord	1.8, 2.0; 2.2 (-93); 2.0i (93-)	
	Shuttle	2.2i;	
	Civic	1.6 VTI	
	Accord	(90-)	
	Prelude	2.0 16V (-90)	
LAND ROVER	Discovery MPi	2.0 16V (93-), motor 20T4	
MAZDA	121	1.25	
OPEL	Cavalier	2.5	
	Calibra	2.5	
	Vectra	2.5	
	Omega	2.5; 3.0	
	Sintra	3.0	
	Astra	1.8; 2.0 16V	
	Cavalier	2.0 16V	
	Calibra	2.0 16V/Turbo	
	Omega-B	1.6 16V	
	Motor Gasolina OHC	1.2; 1.4; 1.6; 1.8; 2.0	
	Motor Diesel OHC	1.6D i; 1.7D	
	Motor Diesel OHC		
	Diesel Isuzu	1.5D i; 1.7D	
	PEUGEOT	205; 305; 309; 405	1.6; 1.9
		405	1.8; 2.0 (92-)
		605	2.0
		Boxer	2.0
		205; 305	1.8; 1.9D
		306	1.8; 1.9D/TD
309		1.8; 1.9D; 1.8TD	
405		1.8TD; 1.9D	
406		1.9D	
Partner		1.9D	
Talbot/Horizon/Solara		1.9D	
J5/Talbot Express		1.9D	
605		1.9D/TD	
806	1.9TD		
Expert	1.9D		
Boxer	1.9D/TD		
RENAULT	R5	1.6D	
	R9	1.6D	
	411	1.6D	
	Express/Extra	1.6D - motores Diesel F8M	
	Clio; Express/Extra		
	R19	1.9D - motor diesel F8Q	
	Espace	2.1D	
	R21	2.1D	
	R25	2.1D	
	Trafic/Master	2.1D - motor Diesel J8S	
	Clio	1.2; 1.4	
	Express/Extra	R19 1.4	
	Megane/Scenic	1.4; 1.6 - motor E7F/E7J	
	R5	1.7	
	Clio	1.7; 1.8	
	R19	1.7	
	R21	1.7	
	Megane/Scenic	2.0	
	Laguna	1.8; 2.0	
	Trafic	1.7 - motor F3N; F3P; F2R	
Clio Williams; R19; Megane	2.0 16V - motor F7P; F7R;		
Laguna/Safrane	2.0 16V - motor N7Q/N7U		
ROVER	623	(93-)	
	618/620	motor SOHC (93-)	
	216; 416	GTi 16V (-95) motor D16A9, motor K16 DOHC; motor SOHC 820.8V (m8) GTa/GTi 16V K16 (-95)	
	Metro		
	214; 414	K16(89-)	
	216; 416	K16 (95-)	
	MGF	1.8 MPi/VVC (95-)	
	220	M16 (-92)	
	220	Turbo T16 (92-)	
	420	M16 (-92)	
	420	T16 (92-)	
	320	Turbo M16 (-91)	
	620	Ti (94-)	
820	Turbo T16 Vitesse (91-)		
SAAB	900	2.5	
	9000	3.0 V6	
	VW; AUDI; SEAT; SKODA	TDI desde 2000	
	ECOTEC 1.4; 1.6; 1.8; 2.0 16V		



AI010060-B

18.60€

Chaves para injetores 1/2"

Faces: 12
Diâmetro: 22mm
Medida: 75mm



AI010060-C

17.00€

Chaves para injetores 1/2"

Faces: 12
Diâmetro: 27mm
Medida: 78mm



AI010060-D

17.70€

Chaves para injetores 1/2"

Faces: 12
Diâmetro: 28mm
Medida: 78mm



AI010063A

61.30€

Medidor de tensão de correias



AI010086

153.80€

Jogo de 12 chaves para terminais



AI010092

86.90€

Bloqueador do volante do motor



AI010104

45.60€

Ferramenta para retirar a tampa do depósito de combustível

Ajustável entre 122-199mm



AI010127

6.90€

Chave de remoção da correia trapezoidal

Aplicação: VOLVO e grupo VAG

AI010137

48.50€

Organizador para peças desmontadas

AI010090A

101.50€

Jogo de 22 chaves para alternador

AI010166

10.30€

Chave torx para polie alternador 1/2"

Medida: T50

Comprimento: 110mm

AI010167

10.90€

Chave XZN para polie alternador 1/2"

Medida: M10

Comprimento: 110mm

AI010176

47.30€

Chave de remoção do filtro de combustível

Esta ferramenta torna a tarefa rápida e fácil de executar reduzindo os riscos de danificar o alojamento plástico do filtro.

Composição:

Marca	Modelo	Aplicação
CHEVROLET	Captiva, Epica	2.0 VCDi
CITROËN	Hdi Relay	2.0; 2.2; 2.8; 3.0
FIAT	500; Doblo; Strada;	1.3 JTD
	Idea; Panda; Punto	
	Idea; Multipla; Punto;	1.9 JTD
	Sedici (+2.0 JTD)	
	Ducato	2.0; 2.2; 2.3; 2.8; 3.0 JTD
LANCIA	Musa; Ypsilon	1.3 MJTD
OPEL	Agila; Astra; Corsa;	1.3 CDTi
	Combo; Meriva; Tigra	
	Astra; Signum; Vectra;	1.9 CDTi
	Zafira	
PEUGEOT	Boxer	2.0; 2.2; 2.8; 3.0 HDI
SAAB	9-3	1.9 TiD
SUZUKI	Splash; Swift; SX4	1.3 DDiS

AI010195

125.90€

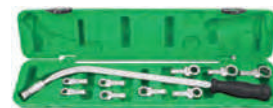
Chave tensionadora de correias com 10 peças

AI020015

27.30€

Grampo para válvulas

Capacidade: 60-120mm

Altura: 150mm

AI0200
Grampo para segmentos

Ref.

 Capacidade
(mm)

Preço

AI020019 115-180 32.80€

AI020020 70-108 25.10€

AI020021 50-100 22.80€

AI020024

94.70€

Grampo para válvulas

Para motores grandes/ diesel

AI020025

80.00€

Grampo para válvulas

Capacidade: 55-175mm

AI020027

37.10€

Desmonta válvulas universal com gancho

Compressor molas de válvulas

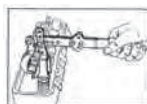
AI020047

25.60€

Extrator das juntas das válvulas

AI020048

Grampo para segmentos

Ref.	Capacidade (mm)	Altura (mm)	Preço
AI020048A	57-125	82	17.30€
AI020048D	90-175	100	18.90€
AI020048E	90-175	165	33.10€



AI020043

Alicate para abraçadeiras de folos



22.80€

AI020049

Grampo universal para válvulas



86.90€

AI020051

Kit teste de compressão para motores a diesel

BMW, CITROËN, DACIA, DAF, DAIHATSU, FIAT, FORD, ISUZU, LAND ROVER, MAZDA, MERCEDES, MITSUBISHI; NISSAN, OPEL, PEUGEOT, RENAULT, ROVER, SEAT, TOYOTA, VOLKSWAGEN, VOLVO

Manómetro: 0-70bar

Diâmetro: 80mm

Turbo: 355mm

Adaptadores:

M10x1 (73,5mm); M10x1 (114,5mm);

M10x1 (119mm); M12x1,25 (54mm);

M14x1,25 (72mm) e M20x1,5 (78mm)

Simulador bucal 19 e 21 mm



261.80€

AI020052

Kit teste de medição compressão em motores a gasolina

Inclui adaptadores e reparadores com rosca

Medidas: M10; M12; M14 e M18



178.30€

AI020054

Kit teste para a pressão do óleo

Inclui adaptadores e reparadores com rosca

Manómetro: 0-10bar/80mm

Turbo: 1 300mm

Jogo de 10 adaptadores



183.90€

AI020056A

Alicate para juntas de válvulas



26.70€

AI020066

Alicates cinta de segmentos

Abertura: 73-111mm



91.90€

AI020101A

Dispositivo para teste de injetores common rail diesel

Este dispositivo permite medir rápida e eficientemente a quantidade de combustível de retorno de cada injetor, permitindo assim verificar se existe alguma anomalia. Medição até 6 injetores em simultâneo.

Inclui adaptadores para injetores Bosch, Delphi, Denso e Siemens.



158.30€

AI020101A-A

Jogo de copos de substituição para AI020101A



55.20€

AI020103

64.60€

Extrator de inércia para desmontagem de injetores

Feito de aço endurecido de alta qualidade.
Desmontagem rápida e fácil de injetores presos em motores a diesel.
Preparado para rosca M8; M12 e M14



AI020158

118.10€

Jogo de 150 anilhas de cobre para injetores com 15 medidas

Composição:

13,85x7,3x1,4; 14,60x7,5x1,3; 14,60x7,5x3,0; 15x7x2;
15x7,5x1; 15x7,5x1,5; 15x7,5x2; 15x7,5x2,5; 15x7,5x3;
15,5x7,5x2; 16x7,5x1,5; 16x7,5x1,7; 16x7,5x2; 16x7,4x2
e 20x9,4x0,9



AI020107

186.10€

Ferramenta de ajuste do ponto de injeção

Permite efetuar o ajuste do ponto de injeção em motores diesel com bomba injetora convencional.
Aplicável entre outros em veículos ALFA ROMEO, AUDI, BMW, FIAT, FORD, ISUZU, IVECO, LANCIA, LAND ROVER, MITSUBISHI, NISSAN, RENAULT, ROVER E VOLKSWAGEN.



AI020109

94.10€

Jogo de 6 chaves para velas de incandescência

Composição/ medidas (mm):

Chaves: 8; 9; 10; 12; 14 e 16
Comprimento: 160mm



AI020131

141.40€

Compressor de molas de válvulas

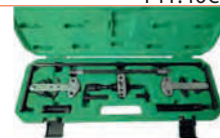

AI020142

429.00€

Jogo de saca rolamentos pequenos

Composição/ medidas (mm):

Saca
Barra
Expansores: 6 a 8; 8 a 10; 12 a 15 e 15 a 18



AI020162

26.20€

Alicate de pontas direitas para remoção de relays



AI020163

25.60€

Alicate de pontas angulares para remoção de relays



AI020178

376.60€

Kit remoção de velas de incandescência danificadas

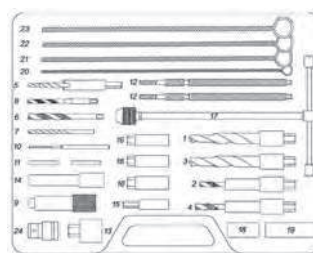

AI020180

139.30€

Teste de sistemas turbo

Este kit pela insuflação de ar comprimido de baixa pressão no sistema do turbo, permite a verificação de fugas.

Composição: 4 pares de adaptadores

Ø	Medida (mm)
55-60	64
65-70	74
75-80	84
85-90	94



AI020184 16.70€

Chave para injetores MERCEDES BENZ

Quadra: 1/2"
Medida: 17mm
Comprimento: 119mm



AI020184A 17.00€

Chave para injetores BMW e Volkswagen

Quadra: 1/2"
Medida: 14mm
Comprimento: 119mm



AI020184B 18.60€

Chave para injetores MERCEDES BENZ

Quadra: 1/2"
Medida: 19mm
Comprimento: 119mm



AI020184S 51.40€

Jogo de 3 chaves 1/2" para linha de injeção

Composição:

Ref.	Medida (mm)	Aplicação
AI020184A	14	BMW; VW
AI0200184	17	Mercedes 100, 130, 314, 360, 360h, 352A, 346/355, 401, 402, 403, 407h, 615, 616 e 617
AI0200184B	19	Mercedes 314, 352, A, 346/355, A, 401, 402/422, LA, 403, 407



AI020185 22.90€

Chave luneta aberta dobrada

Chave especial para desmontar tubos de alta pressão do sistema de combustível em motores a diesel
Medidas: 17x17mm



AI020201 74.70€

Jogo de 6 chaves de caixa com luneta aberta

Especialmente concebidas para trabalhar em espaços apertados e de difícil acesso.

Quadra: 1/2"
Comprimento: 100mm
Medidas: 12; 14; 16; 17; 18 e 19mm



AI020205 142.60€

Saca para injetores (diesel/ gasolina)

Saca especialmente concebido para a remoção de injetores Diesel e Gasolina. As garras são intermutáveis o que permite abranger um maior número de tipos de injetores.



AI030007 22.40€

Jogo de 5 peças para raspar, limpar e tirar juntas



AI050043S 24.00€

Jogo de 3 raspadores

Medidas: 15; 20 e 30mm



AI030010 5.20€

Ferramenta para rodar válvulas grandes



AI030011 4.50€

Ferramenta para rodar válvulas pequenas



AI030020 22.30€

Estetoscópio de mecânico

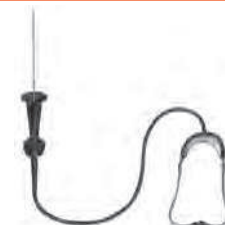

AI030025 7.30€

Jogo de riscador/ tira o-rings e juntas



AI030027

47.40€

Jogo de 6 riscadores com punho



AI040007

14.20€

Alicate para segmentos
Medidas: 1,2 a 6,3mm



AI040008

112.50€

Kit completo para teste de vácuo e sangrar travões



AI040031

161.60€

Bomba para vácuo e pressão com kit sangrador travões
Selecionar a válvula de controlo para a função de vácuo ou pressão.



AI040005

20.10€

Alicate de pontas curvas para anéis de segurança



AI040006

20.10€

Alicate de pontas direitas para anéis de segurança



AI040011

17.60€

Alicate para velas com pontas isoladas



AI040017

65.20€

Jogo de alicates de freios de cabeças recambiáveis

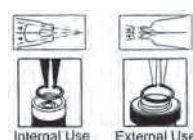

AI040018

25.20€

Alicate para abraçadeiras



AI010201

101.40€

Chave flexível para tubos de combustível
Permite trabalhar em locais com pouco espaço.



AI040060

31.90€

Alicate para tubos de combustível
Alicate para ligações rápidas de tubos de combustível.



Novo AI040064

37.90€

Alicate para freios de segurança



AI040246

47.90€

Jogo para desligar tubos de combustível

Composição:

- 1 Chave direita para tubos 11,8mm
- 1 Chave direita para tubos 16mm
- 1 Chave angular para tubos 11,8mm
- 1 Chave angular para tubos 16mm



AI030002

32.30€

Jogo de 11 chaves para bujões óleo

Quadra: 3/4"

Utilização: chave de caixa 19mm

Hexagonais

8mm: BMW/ FORD/ GM

9mm: GM

10mm: FORD

12mm: FIAT/ LANCIA/ PEUGEOT/

14mm: LANCIA/ MERCEDES

17mm: AUDI/ BMW/ DAC

Quadradas + cabo

8mm: PSA/ RENAULT/ VOLVO

9,5mm: HONDA/ MAZDA/ PEUGEOT/ SAAB/ VOLVO

11mm: FORD

13mm: NISSAN/ SUBARU



AI050004

66.50€

Jogo de 15 peças de copo para filtros

Composição:

Faces	Medidas (mm)	Aplicação
14	65	GM, DAIHATSU, TOYOTA
14	65-67	DAIHATSU
14	68	MAZDA, FORD ESCORT, SUBARU
14	73	TOYOTA, LEXUS
15	74-76	SATURN
15	75-77	VW, AUDI, FORD, ISUZU, MERCEDES, OPEL
14	76	VW, PORSCHE, MERCEDES, BMW, AUDI A3, OPEL
30	76	FORD
15	80	NISSAN, HONDA, MAZDA, ISUZU, SUBARU, OPEL, TOYOTA
15	80-82	MAZDA, SUBARU, TOYOTA, HONDA, ACURA, NISSAN
15	90	HONDA ACCORD, MITSUBISHI, ISUZU
15	93	OPEL, MAZDA, VOLVO, MITSUBISHI, NISSAN, VW, PORSCHE, RENAULT, FORD, HONDA, AUDI
36	93	FORD
15	100	ISUZU, MITSUBISHI

Adaptador 1/2" (F)x3/8"(M)





HC

Chaves de copo para filtros

Ref.	Faces (mm)	Medida (mm)	Preço
HC-100/15	15	100	5.70€
HC-106/15	15	106	6.00€
HC-108/15	15	108	5.20€
HC-108/18	18	108	5.60€
HC-65/14	14	65	6.00€
HC-65/67	14	65-67	5.80€
HC-65103		65-120	18.90€
HC-66/6	6	66	5.30€
HC-68/14	14	68	5.30€
HC-73/14	14	73	5.60€
HC-74/15	15	74	5.60€
HC-74/76	15	74-76	5.80€
HC-75/77	15	75-77	5.80€
HC-76/12	12	76	5.60€
HC-76/14	14	76	5.60€
HC-76/30	30	76	5.60€
HC-76/8	8	76	5.50€
HC-78/15	15	78	5.50€
HC-80/15	15	80	5.60€
HC-80/82	15	80-82	5.20€
HC-86/16	16	86	5.70€
HC-86/18	18	86	5.60€
HC-9.5mm	adaptadores 1/2"-3/8"		2.20€
HC-90/15	15	90	5.70€
HC-92/10	10	92	5.70€
HC-93/15	15	93	5.70€
HC-93/36	36	93	5.60€
HC-93/45	45	93	5.70€
HC-95/15	15	95	5.80€
HC-96/18	18	96	5.60€



AI050004A

156.00€

Jogo de 30 peças de copo para filtros

Composição:

Faces	Medida (mm)	Aplicação
14	65	GM, DAIHATSU, TOYOTA
14	65-67	DAIHATSU
14	68	MAZDA, FORD ESCORT, SUBARU
14	73	TOYOTA, LEXUS
15	74	AUDI, GM, ROVER, CHRYSLER
15	74-76	SATURN
15	75-77	VW, AUDI, FORD, ISUZU, MERCEDES, OPEL
8	76	FIAT MAREA, LANCIA DELTA
12	76	FIAT (DUCATO, SCUDO, ULYSSE), RENAULT (MEGANE, LAGUNA, ESPACE)
14	76	VW, PORSCHE, MERCEDES, BMW, AUDI A3, OPEL
30	76	FORD
15	78	NISSAN, FORD, TOYOTA
15	80	NISSAN, HONDA, MAZDA, ISUZU, SUBARU, OPEL, TOYOTA
15	80-82	MAZDA, SUBARU, TOYOTA, HONDA, ACURA, NISSAN
16	86	Volvo (S40, S60, S70, S80)
18	86	VW (GOLF TDI, PASSAT/TDI), AUDI A6 TDI, RENAULT (CLIO, RAPID 1.9D, LAGUNA, SAFRANE, ESPACE 2.1D, CITROEN; PEUGEOT
15	90	HONDA ACCORD, MITSUBISHI, ISUZU
10	92	FIAT (CINQUECENTO, COUPE, CROMA, PANDA, REGATA, RITMO, SEICENTO, TEMPRA, TIPO), LANCIA (BETA, DEDRA, KAPPA, THEMA)
15	93	OPEL, MAZDA, VOLVO, MITSUBISHI, NISSAN, VW, PORSCHE, RENAULT, FORD, HONDA, AUDI
36	93	FORD
45	93	VW AUDI (2.4; 2.6; 2.8L)
15	95	TOYOTA, ALFA, GM, FORD, CHRYSLER
18	96	AUDI (A4, A6TDI), VW (PASSAT 97 TDI), RENAULT (LAGUNA 2.2D, SAFRANE 2.2D, ESPACE 2.2D, R19, RAPID, MEGANE 1.9/2.1D)
15	100	ISUZU, MITSUBISHI
15	106	FIAT DUCATO 2.5 TD
18	108	RENAULT (ESPACE, LAGUNA,
15	108	MASTER, SAFRANE, TRAFFIC 2.4; 2.5; 2.8D)

Chave filtro de óleo ajustável 65-120
Adaptador 1/2"(F)x3/8"(M)



AI050009A

9.80€

Chave de filtros

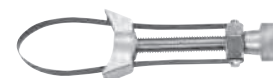

AI050022

12.60€

Chave de filtros

Ajustável: 60-90mm



Novo

AI050008-10

14.40€

Chave de filtros

Ajustável: 55-85mm



AI050024

24.50€

Jogo de 4 alavancas

Medidas: 200; 330; 540 e 600mm



AI050001

23.40€

Chave de filtros de 3 pernas

Capacidade: 60-120mm



AI050037

21.70€

Chave de filtros de 3 pernas

Capacidade: 45-110mm



AI030067

47.80€

Jogo de 17 chaves para bujões de óleo 3/8"

Composição:

6 Chaves hexagonais: 8; 9; 10; 11; 12; 13 e 14mm

9 Chaves quadradas: 7; 8; 10; 11; 12; 13 e 14mm 5/16" e 3/8"

1 Chave quadrada (fêmea): 10mm

1 Chave triangular



AI050040

13.30€

Chave para bujões

Medidas: 8 e 10mm



AI050175

20.10€

Chave para remover/ instalar o alojamento plástico dos filtros de óleo

Aplicação: Motores TDCI - HDI - Ford, Peugeot, Citroën



AN010009A

8.00€

Chave para bujões de carter

Medidas (mm): 10; 11; 12; 13; 14; 15 e 17mm

Comprimento: 150mm



AN010030

16.70€

Alicate para remoção de pesos de rodas



AI050042

21.70€

Chave para remoção de ventoinha

Medidas: 8 e 10 mm



AI050043

22.70€

Alicate de pressão para filtros de óleo

Medida: 53-118mm



AI050076

66.30€

Chave de filtros ajustável 1/2"

Medida: 60-80mm



AI050077

20.10€

Chave de filtros de cinta

Medida: 25-160mm



AI050080

11.10€

Chave para parafusos cabeça do motor 1/2"

Medida: M9

Comprimento: 100mm



AI05009

Chave de velas longa 3/8"

Ref.	Medida (mm)	Compr. (mm)	Preço
AI050092	14	250	19.50€
AI050093	16	250	20.20€

Novo
AI040038

Chave Velas VAS, Mercedes, Smart

42.90€

AI050096S

Jogo de 7 chaves especiais

 Sensores de vácuo e de oxigénio
Válvulas pressostáticas

61.80€

AI050102

Chave de filtros 3 pernas auto ajustáveis

Capacidade: 95-165mm

91.90€

AI050202

Chave de copo para filtros de 14 faces 3/8" com 54mm

11.10€

Marca	Modelo	Motorização
TOYOTA	Auris/ Corolla/ Prius	1.8/ 2.0 4 cilindros

AI010033

Chave para sensor de oxigénio

8.50€



Mecânica

AI050104

Chave para sensor de oxigénio

Medida: 22mm

24.30€

AI050109

Chave de filtros de corrente

 Comprimento: 350mm
Filtros: 60 a 105mm

55.20€

AI050110

Chave de filtros de corrente

 Comprimento da corrente: 520mm
Filtros: 60-165mm

63.50€

AI050113

Jogo de bits impacto de 3/4" e 1"

 Composição/ medidas (mm):
5 Chaves torx T60, T70, T80, T90 e T100 (107mm)
4 Chaves hexagonais 17, 19, 22 e 24mm (107mm)
4 Chaves torx E18, E20, E22 e E24 (107mm)
1 Chave sextavada 3/4" 22mm
1 Chave sextavada 1" 22mm
1 Chave hexagonal em L 4mm

219.00€

AI050152

Tubo para descarga de óleo usado do alojamento do filtro

25.00€

AI050152A

Tubo para descarga de óleo usado do alojamento do filtro

Aplicação: TOYOTA e LEXUS

14.30€

AI050191

Chave magnética para bujões

14.20€



AI050176 221.70€

Kit para montagem de correias estriadas com 11 peças

Composição:

Marca	Modelo
AUDI	A3
BMW	118/ 120/ 318/ 325/ 330/ 335/ 520/ 525/ 530/ 535/ 635/ 720/ 730/ X3/ X5
CITROËN	C2/ C3/ C4/ Jumper/ Relay
CHRYSLER	Grand Voyager/ Voyager
FIAT	Albea/ Doblo/ Ducato/ Fiorino/ Marea/ Multipla/ Qubo/ Linea/ Palio/ Siena/ Stilo e Strada
FORD	C-Max/ Courier/ Fiesta/ Focus C-Max/ Fusion/ Mondeo/ Tourneo/ Transit
IVECO	Daily
LANCIA	Lybra
MAZDA	2/ 3/ 5/ Axela
MERCEDES	Sprinter/ Viano/ Vito
MINI	ASX
PEUGEOT	206/ 207/ 307/ Boxer
SEAT	Altea/ Ibiza
SKODA	Octavia/ Yeti
VOLKSWAGEN	EOS/ Golf/ Passat/ Polo/ Sirocco
VOLVO	C30/ S40/ V50



AI010093 37.70€

Ferramenta para montagem/ desmontagem de correias elásticas poli-v



AE300180 52.40€

Funil para líquido refrigerante

Dimensões: 160x160x260mm
Funil + 2 adaptadores



AE300179-02 45.70€

Adaptadores para funil líquido refrigerante AE300180



AE300179-03 45.70€

Jogo de 6 adaptadores para funil líquido refrigerante AE300180

Adaptadores para veículos Europeus.



AE300221

Adaptadores para funil líquido refrigerante AE300180

Ref.	Aplicação	Preço
AE300221-02	Veículos Japoneses	17.30€
AE300221-03	Honda, Toyota	24.50€
AE300221-04	Ford, Mazda, Mitsubishi, Nissan	17.80€



AI050192 42.90€

Funil universal para óleo

Grampo de fixação ajustável: 28-74mm



AI060006 9.60€

Reparador "rosca" alojamento de velas

Medida: 14mm



AI060020 4.20€

Apalpa folgas com 20 lâminas

Medidas (mm): 0,05; 0,10; 0,15; 0,20; 0,25; 0,30; 0,35; 0,40; 0,45; 0,50; 0,55; 0,60; 0,65; 0,70; 0,75; 0,80; 0,85; 0,90; 0,95 e 1



AI060030

229.10€

Kit de reparação de roscas de alojamento de velas com 56 peças

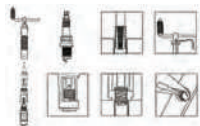
AI060030

Helicoides

Ref.	Medida	Quadra	Quantid.	Preço
AI060030-A	M10x1,0	3/8	10	8.40€
AI060030-B	M12x1,25	3/4	10	16.40€
AI060030-C	M14x1,25	7/16	10	18.70€

AI060030

Punção

Ref.	Medida	Quantid.	Preço
AI060030-D	M10x1,0	1	12.80€
AI060030-E	M12x1,25	1	16.20€
AI060030-F	M14x1,25	1	23.10€

AI060031

150.40€

Kit reparador de roscas com 87 peças

Composição:

Helicoides:

Medidas:

25x M6x1.0x1.5 (9mm)

25x M8x1.25x1.5 (12mm)

25x M10x1,5x1,5 (15mm)

Macho:

M6x1.0

M8x1.25

M10x1.5

Punção:

M6x1.0

M8x1.25

M10x1.5

Broca:

6,3mm

8,3mm

10,4mm

Punho:

M6x1.0

M8x1.25

M10x1.5



Mecânica

AI060031

Helicoides

Ref.	Medida	Quantid.	Preço
AI060031-A	M6x1,0	10	6.10€
AI060031-B	M8x1,25	10	7.10€
AI060031-C	M10x1,5	10	9.50€

AI060031

Punção

Ref.	Medida	Quantid.	Preço
AI060031-D	M6x1,0	1	7.70€
AI060031-E	M8x1,25	1	10.30€
AI060031-F	M10x1,5	1	13.60€

AI060031

Broca

Ref.	Medida (mm)	Quantid.	Preço
AI060031-G	6,6	1	5.30€
AI060031-H	8,3	1	9.20€
AI060031-J	10,4	1	14.90€

AL010006

36.20€

Jogo de 3 alicates

Para ligações rápidas de tubos de combustível

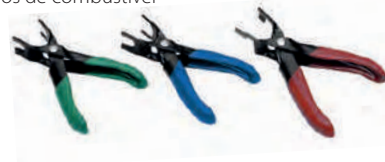
AL010011

25.90€

Chave para fêmeas suspensão

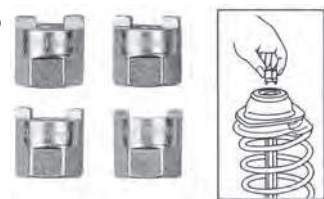

AL010073

193.90€

Kit para remoção das cabeças dos amortecedores

Aplicação: BMW, Fiat, Honda, Mercedes, Mitsubishi, Nissan, Opel, Peugeot, Renault, Suzuki, Toyota e Volvo

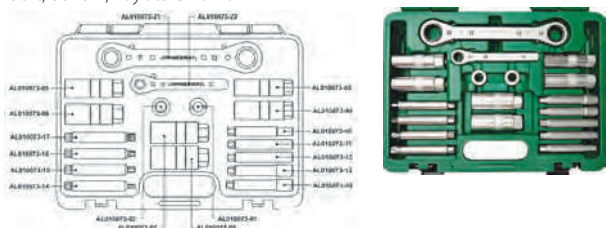

AN010001

56.80€

Kit de ferramenta para travões com 11 peças

Para recuar e rodar êmbolos dos travões



AN010001C

75.40€

Kit de ferramenta para travões com 18 peças

Para recuar e rodar êmbolos dos travões



AN010001D

200.60€

Kit de ferramenta para travões

Para recuar e rodar êmbolos dos travões



AN010001D

Adaptadores

Ref.	Marca	Preço
AN010001D-2	Citroën, Honda	7.60€
AN010001D-3	Vários	8.00€
AN010001D-4	Vários	5.20€
AN010001D-5	Adaptador 3/8"	6.90€
AN010001D-6	Nissan, VW	5.10€
AN010001D-7	Vários	5.10€
AN010001D-A	Renault	5.10€
AN010001D-E	Nissan, Ford	5.10€
AN010001D-F	Opel	5.10€
AN010001D-K	Citroën	8.20€
AN010001D-M	Vários	5.10€
AN010001D-N	Ford, Mazda, Mini	5.10€



AN010293

41.10€

Chave especial para pressionar as pinças de travão

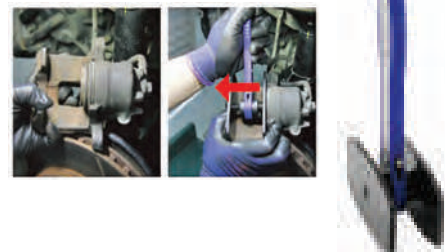

AN010102

16.70€

Alicate para comprimir a mola do travão de mão



AN010321

26.70€

Alicate para cabo do travão de mão



AN010322

41.20€

Alicate para molas de travões do tambor



AN010033 6.50€

Removedor do interior de válvulas 

AN010085A 17.40€

Ferramenta para colocar válvulas de pneus 

AN010038 8.60€

Extrator de vedantes 

AN010049 14.50€

Centrador de embraiagens 

AN010063 75.80€

Alicate para freios de travão 

AN010065 74.70€

Jogo de 4 pinças para cilindros de travão 

AN010081A 27.60€

Alicate de molas de travões 

AN010160 22.30€

Ferramenta para verificação da altura dos calços de travão 

AN010066 51.30€

Kit de desmontagem de embraiagem do compressor A/C
Aplicável em várias marcas de compressores A/C



AN010054A 25.10€

Jogo de 3 alicates para oclusão de tubos 

AN010054N 28.80€

Alicate de pressão para tubos 

AR060062 40.80€

Alicate tensor para abraçadeiras de tubos
Amplitude: 5 a 55mm 

AN010068 8.00€

Limpa bornes e terminais de bateria 

AN010072 34.90€

Reparador de rosca interno e externo
Medidas das rosca: 0,8; 1; 1,25; 1,50; 1,75; 2 e 3mm



AN010072C 20.70€

Reparador de roscas SAE (polegadas)
Medidas das roscas: 9"; 10"; 16"; 20"; 27"; 28" e 32"



AN010091A 111.30€

Removedor da barra de direção

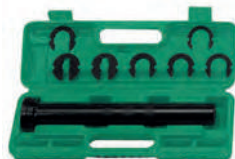

AN010092 84.50€

Chave excêntrica para direções/ barras
Medida: 33-42mm



AN040327 30.10€

Ferramenta de ajuste do eixo traseiro MB



AI030075 30.90€

Alicate para tubos de escape



AN010106A 55.20€

Corta tubos de escape
Não utilizável em tubos de aço inox
Medidas: 19 a 76mm de diâmetro



AN010106A-C 31.20€

Corrente de corte para corta tubos de escape



AN010112 22.80€

Adaptador para saca de semieixo



AN010131 20.40€

Rolete calçador



AN010137 90.80€

Alicate para cubos de rodas



AN010186B 696.40€

Kit para embraiagens auto ajustáveis



AN010188
Ferro desmonta pneus



Ref.	Medida (mm)	Preço
AN010188A	500	27.00€
AN010188B	350	12.30€
AN010188C	200	5.20€

AN010225 663.00€

Ferramenta para instalar/ remover rolamento manga eixo
Permite rapidez, segurança e profissionalismo sem esforço na tarefa
Aplicação: PEUGEOT, CITROËN e RENAULT



AN010226

20.30€

Medidor de espessura dos discos de travão e profundidade do piso dos pneus

 Discos de travão: 0-60mm
 Material: alumínio

AN010319

135.90€

Medidor digital da espessura dos discos de travão e profundidade da espessura pneus

Capacidade medição: 0-100mm

AN010320

90.30€

Medidor dos discos de travão

AG010205

22.30€

Medidor digital de profundidade

Utilizado para medir a profundidade do piso dos pneus e das pastilhas de travões.

Especificações:

Gama de medição: 0-25,4mm

Resolução: 0,01mm

Display: LCD

Medição em milímetros ou polegadas.

Utiliza pilhas SR44/ LR44 de 1,4V (não incluídas).

AN010272

16.20€

Alicate para tampas plásticas fêmea da roda

Permite retirar as tampas plásticas das fêmeas da roda sem danificar as jantes.

AN010279

406.70€

Mecanismo para desbloqueio de roda MB/ BMW

Aplicação

Mercedes Benz: W164 (Classe GL); W197 (SLS); W204 (Classe C); W212 (Classe E); W221 (Classe S) e W251 (CLR)

BMW: F01/F02 (Série 7); F07/F10 (Série 5);

F12/F13 (Série 6); F25 (x3) e

F30/ F31/ F32/ F33/ F34 (Séries 3 e 4)

AN020007

33.40€

Despolidor de cilindros

Medida: 51-177mm

AN020007-1

14.20€

Jogo de 3 pedras para despolidor de cilindros

Aplicável ao despolidor AN020007

AN020022

35.00€

Jogo de despolidor de cilindros

Composição/ medidas (mm):

Medida: 18-89

Pedras: 19; 28,8 e 51

Jogo de pedras de substituição

AN020022
Jogo de pedras para despolidor de cilindros

Ref.	Medida (mm)	Unidades	Preço
AN020022-A	51	3	9.60€
AN020022-B	28,8	2	6.90€
AN020022-C	19	3	6.50€
AN020022-D	28,8	2	6.10€

AN040035A

19.90€

Corta tubos

AN040043A

66.90€

Jogo de cortar tubos e abocardador

Composição/ medidas (mm):

Fixador de tubos: 4; 6; 8; 10; 12; 15 e 16

Punções abocardador: 4; 6; 8; 10 e 12

AN040101

8.70€

Bit 1/2" pentagonal para freios travões

AN040168

490.30€

Jogo de ferramenta para instalar/ remover rolamentos de roda
Permite rapidez, segurança e profissionalismo sem esforço na tarefa
Para rolamentos: 60 a 85mm



AR020018

27.80€

Teste de compressão

Tubo flexível com adaptador: 14 e 18mm
Escala: 0-300psi; 21kg/cm²; 21bar e 2 100kpa



AR020019

26.70€

Teste de vácuo e bomba combustível



AR020053A

262.10€

Kit de acessórios eletricitista/ eletrônica auto



AR030013

4.80€

Densímetro para líquido de baterias



AR030034

7.20€

Auto tester circuitos entre 3-48V
Indicação da polaridade por Leds



AR030041

84.90€

Jogo de 7 aplicadores de o'ring

Composição/ medidas (mm):
14,4-16; 15,9-17,5; 17,5-19,1; 20,7-22,4;
24-26; 25,5-27,5 e 30,3-32,3



AR030047

27.90€

Teste fluido de travões
Bateria não incluída.



AR030062

46.20€

Teste de atuadores

Este aparelho permite o teste a componentes eletrónicos que atuem por campos magnéticos e eletromagnéticos.



AR040043

20.20€

Saca terminais de cabo de bateria e limpa parabrisas



AR040016

91.40€

Jogo de cabos de arranque de bateria 500 Amp

Dimensões: 0.3x268x12mm
Comprimento: 3 600mm



AR060002A

29.90€

Alicate para abraçadeiras - matriz "+"



AR060003

19.60€

Alicate para abraçadeiras - matriz "V"



AR060008

19.80€

Alicate para abraçadeiras de filtros de combustível e tubos de vácuo



Novo

AR060009

21.60€

Alicate de aperto para abraçadeira de baixo perfil



AR060038

22.30€

Alicate angular para abraçadeiras tubos



AR060039A

21.70€

Alicate para abraçadeiras tubos



AR060055

28.70€

Alicate de abraçadeiras de tubos
Abertura de 22 a 55mm



AR060056

32.30€

Alicate abraçadeiras tubos
Medida: 0-38mm



AR060010

26.00€

Alicate para tubos do radiador



AR060020

16.20€

Alicate para remover tubos



AR060021

55.20€

Alicate para abraçadeiras



AR060024A

221.40€

Kit de 7 alicates para abraçadeiras



AN010177B

64.60€

Alicate especial para abraçadeiras de fole



AR060029A

83.20€

Alargador de foles



Novo

AR060032

20.90€

Kit de adaptadores para desencaixe de tubos A/C



AR060043

133.70€

Jogo de 52 peças para remoção de rádios

Aplicação:
Marca Auto: AUDI; BMW; FIAT; FORD; SKODA;
MERCEDES; OPEL; PORSCHE e VOLKSWAGEN
Marca Rádio: Becker; Blaupunkt; Clarion; JVC;
Grundig; Kenwood; Panasonic; Pioneer e Sony



Ferramenta - aplicação especial por MARCAS GRUPO BMW e MINI

AI010121

75.80€

Chave para boia do depósito de combustível

Aplicação: AUDI, BMW, MERCEDES, PORSCHE e VOLKSWAGEN



AI010139

135.90€

Ferramenta para desmontagem do sensor do nível de combustível

Aplicação: BMW e MINI

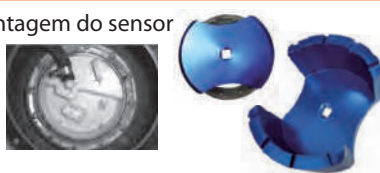

AI020184A

18.00€

Chave para injetores BMW e Volkswagen

Quadra: 1/2"

Medida: 14mm

Comprimento: 119mm



AI050071S

386.70€

Jogo de 8 chaves especiais BMW

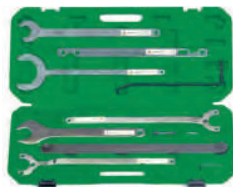

AL010099

345.50€

Kit comando de motor diesel BMW

Modelo	Motorização
E34/ E36/ E38/ E39/ E46/	M41/ M51/ M47TU/ M47T2/
E53/ E60/ E61/ E63/ E65/	M57TU/ M57T2
E66/ E70/ E83/ E87/ E90/ E91/	
Land Rover	2.5DT/ 3.0TD6/
Freelander	2.0TD4



AI010115

33.10€

Saca bombas injetoras BMW

Modelo	Motorização
318D/ 320D/TD/ 330D	E46
525D/ 530D	E39
525D/ 530D/ 535D	E60/E61
730D	E38
X5 3,0D	E53



AL010128

68.30€

Kit comando de motor BMW

Modelo	Motorização	Ano
118d	E87	2003-2007
120d	E87	2003-2007
318d/td	E46 E90/91	2000-2008
320d/crd	E46 E90/91	1997-2008
325d	E90/91/92/93	2006-2010
330d/xd/crd	E46 E90/91/92/93	1998-2008
510d	E39 E60/61	1999-2010
525d/xd	E39 E60/61	1999-2010
530d/xd	E39 E60/61	1998-2010
535d	E60/61	2004-2010
635d	E63/64	2004-2010
730d	E38 E65/66	2003-2010
X3 2,0d	E83	2003-2007
X3 3,0d	E83	2003-2010
X5		



**Ferramenta - aplicação especial por MARCAS
FIAT e OPEL**

AL010044

172.70€

Kit comando de motor FIAT/ OPEL

Marca	Modelo	Motorização	Ano	Peças nº
FIAT	Panda/ Idea/ Doblo	1.3JTD MultiJet	2004-2007	7; 8; 9; 10
		1.7D/ 1.9D/ TD/ JTD2.4		1; 3; 4
		1.9/ 2.4JTD 16V/ 20V		2; 3; 4; 5; 6; 7
OPEL	Agila/ Corsa/ Astra H/ Tigra B/ Meriva/ Astra/ Vectra/ Signum/ Zafira	1.3CDTI	2004-2007	7; 8; 9; 10
		1.9CDTI		2; 3; 4; 5; 6; 7
ALFA ROMEO	147/ 156	1.9JTD 16V/ 2.4JTD 20V		2; 3; 4; 5; 6; 7



AL010196

61.30€

Kit comando de motor gasolina

Marca	Modelo	Motorização
ALFA ROMEO	159	939A4.000
CHEVROLET	Aveo/ Cruze/ Orlando	
FIAT	Croma	939A4.000
OPEL	Astra G/ Astra H/ Corsa D/ Meriva A/ Zafira B/C/ Vectra C/ Signum/ Insignia	Z16LEL/ Z16LER/ Z16LET/ Z16ZE1/ Z16XEP/ Z16ZER/ LLu/ A16LET/ A16XEL/ 2HO/A18XEL/ 2HO/A18XE R/Z18XER



**Ferramenta - aplicação especial por MARCAS
FORD, MAZDA e VOLVO**

AL010070

29.00€

Kit comando motor FORD/ PEUGEOT/ CITROËN

Marca	Modelo	Motorização:
FORD	Fiesta/ Fusion	1.4TDCI
	Focus/ Focus C-Max	1.6TDCI
	Fusion/ Fiesta	1.6TDCI
CITROËN	C4	1.6HDI
PEUGEOT	206	1.4HDI
PEUGEOT	307	HDI



AL010071

96.80€

Kit comando motor FORD

Modelo	Motorização	Ano
Fiesta	1.8D Turbo	
Focus		
Focus C-Max	1.8TDCI	
Tourneo Connect	1.8TDDI/ TDCI	
Transit Connect	1.8TDDI/ TDCI	2002-2006



AI010107

89.10€

Kit comando motor FORD

Modelo	Motorização em diesel
Fiesta	1.8TDDI/ TDCI
Focus	Turbo
Transit	
Transit Connect	



AL010175

36.20€

Pino de fixação árvore de cames

Marca	Modelo	Motorização	Ano
FORD	Fiesta/ Fusion	1.4TDCI	2002>2009
	Focus C-Max	1.4/ 1.6TDCI	
	Mondeo	2.0TDI/ TDCI/ 2.2TDCI	
	Transit	2.0TDI/ TDCI/ 2.4TDI/ TDCI	
	VOLVO	S40/ V50	1.6D/ 1.9D



AL010205

10.60€

Kit comando motor FORD/ MAZDA/ VOLVO

Marca	Modelo	Motorização
FORD	C-Max/ Cougar/ Fiesta/ Focus	HWDA/ HWDB/ CSDA/ QQDA/ QQDB/ QQDC/ AODA/ AODB/ DBA/C/ EDBB/ EDBD/ F8JA/ F8JB/ FUJA/ FUJB/ M7JA/ M7JB/ FXJA/ FX JB/ FYJA/ FYJB/ N4JB/ FHA/ FHE/ L1T/ L1V/ ASDA/ ASDB/ FXDA/C/ FXDB/D/ FYDA/C/ FYDB/D/ EYDB
	MAZDA	6
VOLVO	C-30/ S40/ S80/ V50/ V70	B4164S3/ B4184S11/ B4204S3



AL010218

174.90€

Kit comando motor FORD

Modelo:

Fiesta/ Fusion/ Focus/ C-Max/ B-Max/ S-Max/ Mondeo/ Galaxy



AN040286

390.00€

Extrator de sinoblocos

Marca	Modelo	Ano
FORD	Focus I	1998-2005
	Focus II	2004-2008
	CB4	2008-2011
MAZDA	3	2003-2008
	3	2009 ->
	5	2005-2010



**Ferramenta - aplicação especial por MARCAS
HYUNDAI e KIA**

AL010282

76.90€

Kit comando motor HYUNDAI/ KIA

Aplicação:

HYUNDAI: Accent; Elantra; Getz; i10; i20; i30; i40; ix35; ix55; Matrix e Tucson.

KIA: Carens; Cee'd; Cerato; Optima; Picanto; Pro-Cee'd; Rio; Soul; Sportage e Venga.



**Ferramenta - aplicação especial por MARCAS
MERCEDES**

AG010204

11.10€

Chave de impacto para rodas especial - MERCEDES 1/2" com 17mm

Aplicação:

MERCEDES: W204 (Classe C); W204(GLK); W207/ W211/ W212 (Classe E); W166 (Classe M); W221/ W222 (Classe S); W172 (SLK); W164/ W166 (ML) e W216 (CL) e Maybach.



AI010114

43.90€

Jogo de ferramentas para airbag



AI010097

20.90€

Chave hexagonal 1/2" especial para SCANIA e MERCEDES

Comprimento: 27mm



AI010116

53.50€

Saca velas de incandescência

Motorização: 611/ 612/ 613

Comprimento: 10mm



AI020113

179.00€

Jogo saca injetores common rail MB

Motorização:

OM 611/ OM 612/ OM 613



AI020184

16.70€

Chave para injetores MERCEDES BENZ

Quadra: 1/2"

Medida: 17mm

Comprimento: 119mm



AI020184B

18.60€

Chave para injetores MERCEDES BENZ

Quadra: 1/2"

Medida: 19mm

Comprimento: 119mm



AI020186

65.70€

Jogo saca bicos injetores

Modelo

Motorização

Classe C/ Classe E/
Sprinter

108CDI/ 110CDI 16V/ 112CDI 16V/
C220CDI 16V/ E200CDI 16V



AI050071S

386.70€

Jogo de 8 chaves especiais MB

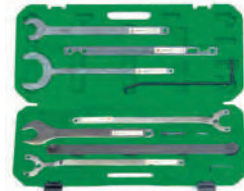

AI050085A

19.50€

Chave de filtros de 14 faces com 74mm

Nota: Se usar com uma chave caixa de 27mm, deve ser aplicada uma força máxima de 25Nm, caso sejam aplicadas forças superiores, corre-se o risco de danificar a chave filtros.

Marca:

MERCEDES/AUDI A3/ BMW E36/ CITROËN/
FIAT/ FORD/ LANCIA/ MAZDA/ NISSAN/
OPEL/ PEUGEOT/ PORSCHE/ RENAULT/
TOYOTA/ VOLKSWAGEN Golf IV



AI050200

98.30€

Jogo de 4 varetas para óleo de transmissão

Aplicacion: Mercedes Benz



AL010057

164.90€

Chave bloqueadora de cambotas MB



AN040126

250.70€

Extrator de sinoblocos eixo traseiro MB



Ferramenta - aplicação especial por MARCAS GRUPO PSA - PEUGEOT/ CITROËN

AI010136

124.80€

Kit comando motor HPI (gasolina) e HDI (diesel) PEUGEOT/ CITROËN

Marca	Modelo	Motorização	Ano
PEUGEOT	206/ 307/ 406	1.8 16V	2000-2004
	607/ 806/ 807	2.0 16V	2002-2005
	Expert		
CITROËN	C4/ C5	1.8/ 2.0HPI	2002-2005
	Xsara	2.0 16V	2002-2005
	Xsara Picasso	1.8/ 2.0 16V	2002-2005
	Evasion/ C8 Jump		

Códigos motor: 6FZ (EW7J4)/ FRN (EW10J4/L4/5)/ RLZ (EW10D)



AL010175

36.20€

Pino de fixação árvore de cames

Marca	Modelo	Motorização
CITROËN	C1/ C2/ C3/ Xsara	1.4HDI
	C3/ C4	1.6HDI
PEUGEOT	107/ 206/ 207	HDI
	307	1.4/ 1.6HDI



AN040100

9.20€

Chave de caixa pentagonal para travões PSA

Medida: 17mm



AL010041

197.20€

Kit comando motor HPI (gasolina) e HDI (diesel) PEUGEOT/ CITROËN

Marca	Modelo	Motorização	Ano	
CITROËN Diesel	Visa/ BX/ ZX/ Xantia/ Xsara/ Synergie/ C15/ Berlingo/ Dispatch/ C25/ Relay	1.7/ 1.8/ 1.9/ D/ TD	1984-2002	
	Saxo/ AX/ Xsara	1.5D	1994-2007	
	Xsara/ Berlingo/ Dispatch	1.9D	1998-2007	
	Xsara/ Xsara Picasso/ Xantia/ C5/ Synergie/ Berlingo/ Dispatch/ Relay	2.0HDI	1998-2007	
	C4	2.0HDI	2004-2008	
	C5	2.2HDI	2000-2004	
	C8	2.0/ 2.2/ HDI	2002-2007	
	Relay	2.5D/ TurboD	1994-2002	
	XM/ Xantia/ Dispatch/ Synergie/ Evasion	2.1D/ 2.2D/ TD	1994-2002	
	CITROËN Gasolina	AX/ Xsara/ AX GTI/ Saxo/ ZX/ Berlingo	1.0/ 1.1/ 1.4/ 1.6	1994-2004
		C2/ C3/ C3 Pluriel/ Berlingo	1.0/ 1.1/ 1.4	2002-2007
		Saxo/ Xsara	1.6 16V	1997-2006
		C2/ C3 Pluriel/ C4	1.6	1997-2006
Xsara/ Xantia		1.8 16V	2002-2008	
ZX/ Xsara		2.0 16V	1996-2000	
Synergie/ Evasion/ Relay/ Jumper		2.0 Turbo	1994-2002	
Xsara		2.0 16V	2000-2004	
Xsara/ C5/ Xsara Picasso		2.0HPI/ 2.0 16V/ 1.8	1999-2002	
Xsara/ C5/ Xsara Picasso		2.0HPI/ 2.0 16V/ 1.8	2002-2008	
PEUGEOT Diesel		205/ 305/ 405/ Partner/ 306/ 309 Talbot Horizon/ Solara Express	1.8/ 1.9/ D/ TD	1982-2001
		206/ 307	1.4 HDi	2001-2008
		206/ 306/ Express/ Partner	1.9D	1998-2007
	206/ 306/ 307/ 406/ 806/ 807	2.0HDI/ 2.0HDI 16V	1997-2007	
	307/ 307 CC/ 407	2.0HDI	2003-2008	
	406/ 607	2.2HDI	2002-2007	
	406/ 806/ Expert/ Boxer	1.9D/ TD	1994-2002	
	406/ 605/ 806	2.1D Turbo	1994-2002	
	PEUGEOT Gasolina	106/ 205/ 306/ 307/ 405/ Partner	1.0/ 1.1/ 1.4/ 1.6	1993-2008
		206	1.1/ 1.4/ 1.6	1998-2008
		205/ 309/ 306/ 405/ 806/ 605/ 406/ Partner/ Boxer	1.6/ 1.9/ 1.8/ 2.0	1989-2002
		206/ 307	1.6 16V	2000-2008
		306/ 407	1.8 16V	1999-2002
206/ 307/ 406/ 406 Coupe/ 607/ 806		2.0 16V	1998-2000	
306/ 406		1.8 16V	1995-1998	
306/ 406		2.0 16V	1994-2001	
306/ 406		1.6/ 2.0 Turbo	1994-2001	
406		1.8 16V	2000-2004	
406/ 406 Coupe/ 607		2.2 16V	1998-2008	
807		2.0 16V	2002-2005	



RENAULT, NISSAN e DACIA

AL010038
23.50€
Kit comando de motor RENAULT/ NISSAN

Marca	Modelo	Motorização
RENAULT	Modus/ Laguna/ Kangoo/ Clio	1.5dCi/ 1.9dCi
NISSAN	Almera/ Micra	1.5dCi

AL010190
71.30€
Kit comando de motor

Marca	Modelo	Motorização	Ano
RENAULT	Clio	1.2/ 1.4/ 1.6	
	Clio Sport	2.0	
	Espace	2.0	
	Scenic	1.4/ 1.6/ 1.8/ 2.0	
	Scenic II	1.4/ 1.6/ 2.0	
	Grand Scenic II	1.4/ 1.6	
	Laguna	1.8/ 2.0	
	Laguna II	2.0	
	Megane	1.4/ 1.6/ 1.8/ 2.0	
	Megane II	1.4/ 1.6/ 2.0	
DACIA	Logan	1.4/ 1.6	
	Sandero	1.4/ 1.6	
NISSAN	Micra		2003>2008
	Almera		2002>2006
	Note		2006>2008
	Qashqai		2007>2008
Diesel		1.2/ 1.4/ 1.6/ 1.8 (8v-16v)/ 2.0IDE/ 2.0Turbo	

Códigos motor: D4F/ K4J/ K4M/ K7M/ K9K/ F4P/ F3R/ F4R/ F5R/ F4RT



Ferramenta - aplicação especial por MARCAS GRUPO VAS - AUDI, VOLKSWAGEN, SKODA, SEAT e PORSCHE

AI010069
26.70€
Ferramenta de bloqueio da cambota VOLKSWAGEN

Para bloquear a cambota quando se quiser substituir a correia ou outros componentes.

Marca	Modelo	Motorização
AUDI	A4/ A6	
SEAT	Alhambra/ Altea/ Arosa/ Cordoba/ Ibiza/ Leon/ Toledo	
VOLKSWAGEN	Bora/ Golf/ Lupo/ Passat/ Polo	TDI's

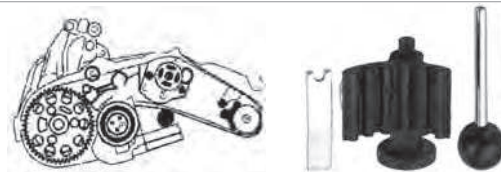
AI010070
37.40€
Ferramenta de bloqueio da cambota (VAS)

Marca	Modelo	Motorização	
AUDI	A2	1.4TDI	
	A3	1.9TDI/ 2.0TDI	
	A4	1.6TDI/ 1.9TDI/ 2.0TDI	
	A6	1.9TDI	
	SEAT	Altea	1.9SDI/ TDI
		Leon	1.9/ 2.0TDI
Toledo		1.9SDI/ TDI	
VOLKSWAGEN	Beetle/ Bora/ Sharan	1.9TDI	
	Fox/ Lupo	1.4TDI	
	Golf	1.9/ 2.0TDI	
	Polo	1.4/ 1.9TDI	

AI020127
50.10€
Ferramenta para tirar injetores

Aplicação: Grupo VAS (motores TDI)

AI020154
326.50€
Instalador vedante da cambota VOLKSWAGEN

Marca	Modelo	Ano
AUDI	A3	2004>
	A4	
SKODA	Octavia2/ Roomster/ Fabia	
VOLKSWAGEN	Golf	2004>
	Transporter T5/ Caddy/ Touran	2004>



AI020184A 18.00€

Chave para injetores BMW e VOLKSWAGEN

Quadra: 1/2"
Medida: 14mm
Comprimento: 119mm



AI050079 14.20€

Chave bujão caixa de velocidades e transmissões 1/2"

Marcas: AUDI e VOLKSWAGEN
Chave estriada XZN Tamperproof M16



AI050201 39.60€

Varetas para óleo

Aplicação: Audi/Volkswagen



AL010029 35.10€

Ferramenta de alinhamento dupla árvore cames motores gasolina

Marca	Modelo	Motorização
AUDI	A2	1.4/ 1.6
SEAT	Arosa/ Ibiza/ Cordoba/ Toledo/ Leon/ Inca	1.4/ 1.6
SKODA	Fabia/ Octavia	1.4/ 1.6
VOLKSWAGEN	Lupo/ Polo/ Golf/ Bora/ Beetle/ Caddy	1.4/ 1.6



AL010053A 70.70€

Kit comando do motor

Marca	Modelo	Motorização	Ano
VOLKSWAGEN	Polo	1.2 6V/ 12V	2002>
SEAT	Ibiza	1.2 6V	2002>
SKODA	Fábia	1.2 6V/ 12V	2003>



AL010072 9.20€

Kit comando do motor

Marca	Modelo
AUDI	A4/ S3/ A6/ TT
SEAT	Ibiza/ Cordoba/ Leon/ Toledo/ Alhambra
SKODA	Octavia
VOLKSWAGEN	Golf/ Bora/ Beetle/ Passat



AL010081 379.00€ **Novo**

Kit comando motor BMW

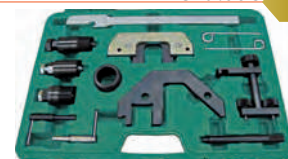

AL010087 220.60€

Kit comando de motor AUDI

Marca	Modelo	Motorização
AUDI	A4	3.2FSI
	A6	2.4
	A6	2.4quattro
	A6	3.2FSI A)
	A8	3.2FSI A



AL010088 88.00€

Kit comando de motor a gasolina

Marca	Modelo	Motorização
AUDI	A3	1.4L/ 1.6 FSI
SKODA	Octavia	
VOLKSWAGEN	Polo/ Golf/ Golf Plus/ Jetta/ Passat/ Touran	



AN010202 31.20€

Chave de impacto especial XZN 3/4" para cubos rodas AUDI/ VOLKSWAGEN

Medida: M18
Comprimento: 105mm



AN010202B 15.40€

Chave de impacto XZN 1/2" AUDI/ VOLKSWAGEN

Especialmente concebida para o aperto dos parafusos que fixam o eixo traseiro

Medida: M18
Comprimento: 78mm



AI010108 26.70€

Ajustador do rolete tensionador

Marca	Modelo
AUDI	A4/ A6/ Cabrio
SEAT	Ibiza
SKODA	Superb
VOLKSWAGEN	Polo/ EOS/ Passat

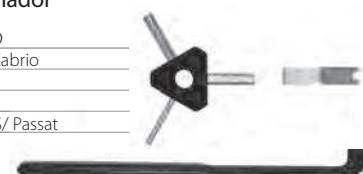

AL010291
132.60€
Kit comando motores VAS

AI010110
245.10€
Jogo sincronismo motor - grupo VAS

Marca	Modelo	Motorização	Ano
AUDI	A3	1.6FSI	2003-2006
	A3/ S3	1.8Turbo	1996-2003
	A4/ A6	1.8Turbo	1994-2006
	Cabriolet		1997-2000
SEAT	TT	1.8Turbo	1998-2006
	Ibiza	1.8Turbo	1999-2002
	Cordoba	1.8Turbo	
SKODA	Leon	1.8Turbo	1999-2005
	Toledo	1.8Turbo	1999-2005
	Octavia	1.8Turbo	1996-2005
VOLKSWAGEN	Octavia	1.8Turbo	2000-2005
	20V RS		
	Golf	1.6FSI	
	Touran	1.6FSI	
	Beetle	1.8Turbo	1999-2006
	Golf/ Bora	1.8Turbo	1997-2005

AL010202
7.20€
Pino fixação cambota - grupo VAS

Esta chave é equivalente à ferramenta especial VAG T10340

Marca	Modelo	Motorização
VOLKSWAGEN	Polo/ Golf/ Golf VI	1.4/1.6TSI/FSI
	Cabrio/ Golf Plus/	
	Golf Variant/ Touran/ EOS/	
	Passat/ Jetta/ Scirocco/	
	Beetle/ Sharan/ Tiguan/	
	Caddy/ Caddy Maxi/ Fox	
AUDI	A3	1.4/1.6TSI/FSI
SEAT	Cordoba/ Ibiza	1.4/1.6TSI/FSI
SKODA	Fabia/ Roomster	1.4/1.6TSI/FSI



Códigos de motor: AWY/ AXU/ AZQ/ BAG/ BBM/ BKG/ BLF/ BLG/ BLN/ BLP/ BMD/ BME/ BMY/ BTS/ BWK/ BZG/ CAVA/ CAVB/ CAVC/ CAVD/ CAXA/ CEVA/ CGPA/ CGPB/ CHFA

AL010203
7.10€
Pino de fixação da cambota - grupo VAS

Esta chave é equivalente à ferramenta especial VAG T40069

Marca	Motorização
AUDI/ SEAT/ SKODA/ VOLKSWAGEN	2.0/ 2.4/ 3.2FSI/ 3.0V6 TDI/ 4.2 V8 TDI/ 2.8/ 1.4/ 1.6 TSI/FSI

Código de motor: BGP/ BGQ/ CBUA/ CBTA/ BPR/ BPS

AL010225
86.90€
Kit comando motores VOLKSWAGEN

Modelo	Motorização	Ano
Transporter	2.4D T4	1995>2003
Código de motor: AAB/ AJA		
Transporter	2.5TDI	1995>2003
Código de motor: ACV/ AHY/ AJT/ AUF/ AXG/ AXL/ AYC		
Crafter	2.5TDI	2006 >2012
Código de motor: BJJ/ BJK/ BJL/ BJM		

ME010001
490.60€
Jogo de guias para montagem de retentores suspensão

Composição:

Ref.	Compr. (mm)
329-01	449/50
329-02	45
329-03	43
329-04	41
329-05	39
329-06	35/36
329-07	48
329-08	54
329-09	46/47

ME010007
37.90€
Chave de montagem/ desmontagem da forqueta invertida

Marca: Kayaba/ Showa

ME010009
12.30€
Saca pip de válvula de ar

ME010010
22.80€
Jogo de guias para casquilhos suspensão

 Composição/ medidas (mm):
12,5; 14; 16 e 18

ME010012
35.70€
Guia para montagem/ desmontagem forqueta invertida

ME020001

43.50€

Removedor do rolamento da coluna da direção
Abertura: 30-68mm



ME020002

68.00€

Ferramenta para instalação rolamento da direção
Diâmetro da haste: 26, 30, 31 e 35mm



ME020003

345.40€

Saca do rolamento da haste da mesa da direção
Medidas (mm): 44, 48 e 51mm



ME020005

100.30€

Guia para instalação do rolamento da direção
Diâmetro da haste: 26, 30, 31 e 35mm



ME020006

278.60€

Dispositivo de instalação das caixas dos rolamentos cônicos na coluna de direção

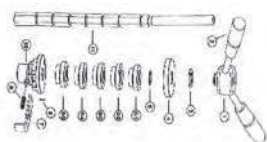

MG010001

48.20€

Saca cubo embraiagem/ polie alternador



MG01000

Chave fêmea da embraiagem



Ref.	Medida (mm)	Pinos	Preço
MG010002	34x59	2	22.30€
MG010003	41x59	2	22.30€
MG010004	39x72	2	25.60€
MG010005	46x72	2	25.60€
MG010006	46	3	25.60€

MG010008

43.40€

Ferramenta para comprimir embraiagem
Para motores 50 a 250cc
com polie de \varnothing 125 a 155mm



MG010009

43.50€

Ferramenta para comprimir embraiagem
Para motores 50 a 250cc
com polie de \varnothing 125 a 155mm



MG020001

41.60€

Corta corrente

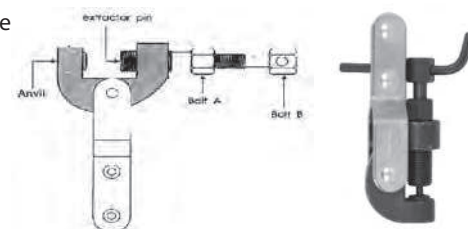

MG020003

83.60€

Corta/ rebitador da corrente



MG020004

13.90€

Alicate para o elo de fecho



MG020006

18.40€

Ferramenta de fecho da corrente (transmissão ou distribuição)



MG020007

61.30€

Kit limpeza da corrente



MG020008

15.70€

Escova limpa correntes



MI010014

25.60€

Saca válvulas do motor



MI010016

52.40€

Removedor/ instalador do pino do piston

Medidas (mm):

Pistões: 40 a 100

Pinos: 12 a 25



MI010017

26.70€

Instalador dos segmentos do pistão



MI010018

25.20€

Protetor em alumínio para torno

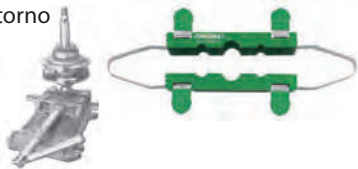

MI010019

215.10€

Ferramenta de auxílio para fecho do motor



MI010020

30.10€

Ferramenta de bloqueio embraiagem/ volante scooter



MI010021

25.60€

Saca para volante magnético



Motociclos

MI020001

13.70€

Chaves para jets 6 e 8mm



MI020002

24.00€

Jogo de chaves para carburadores FCR



MI020004

28.70€

Medidor do nível da altura da bóia do carburador



MN020004

8.90€

Protetor de jantes



MN020005

5.60€

Descolador de pneus



MT010001

9.90€

Oleador de cabos



MT010002

51.80€

Ferramenta de furação da fêmea e parafuso de segurança



MT010003

132.00€

Cavalete para roda traseira



MT010004

130.00€

Suporte central universal



MT010005

25.60€

Chave ajustável bloqueio de embraiagem



MT010006

29.20€

Chave ajustável bloqueio de embraiagem



MT010007

42.30€

EZ-ROLL (sistema rotação roda traseira)



MT010008

9.90€

Gancho para molas



CHAPEIRO

AB010001

53.50€

Kit de 10 peças para montagem de vidros



AB010002

95.80€

Kit de remoção para vidros parabrisas



AB010002-A

18.50€

Bobine de arame para remoção de vidros - 15m



AB010017

22.30€

Faca parabrisas



AB0100

Lâmina em aço para faca parabrisas

Ref.	Medida	Preço
AB010018	3/4"	2.10€
AB010019	1"	2.10€
AB010020	1-1/2"	2.20€



AB010026S

40.60€

Removedor de frisos e plásticos



AB010041 44.60€

Jogo de 12 chaves para remoção de painéis



AB010043 63.50€

Espelho auxiliar para reparação de mossas



AB020002 23.40€

Ventosa simples para vidros



AB020003 55.70€

Ventosa dupla para vidros



AB020009 52.40€

Ventosa dupla articulada para vidros

Estrutura em alumínio
Ventosas: ø115mm



AB020010 74.70€

Ventosa tripla para vidros

Estrutura em alumínio
Ventosas: ø123mm
Capacidade: 35 kg/100 kg



AB020015 8.60€

Jogo de ventosas para colocar vidros



AB020019 44.60€

Jogo de 6 ventosas

Para auxílio durante a colagem de frisos, vidros, etc



AB030001 7.60€

Jogo de 4 espátulas de 25 a 100mm



AB030014 11.80€

Ferramenta para colocação borrachas nos vidros



AB030028 5.10€

Chave para cavilhas e encaixes plásticos



AB030041 5.60€

Chave para cavilhas e encaixes plásticos



AB030043 5.70€

Chave para cavilhas e encaixes plásticos

Encaixe em "V"



AB030046 5.70€

Chave para cavilhas e encaixes plásticos

Encaixe de 8mm



AB030047 3.90€

Chave para cavilhas e encaixes plásticos

Encaixe de 6mm



AB030048 7.40€

Chave para cavilhas e encaixes plásticos



Novo **AB030049** 10.70€

Chave para cavilhas e encaixes plásticos



AB030076

Molas de plástico

Ref.	Quant. Embl.	Preço
AB030076-01	300	21.70€
AB030076-02	300	24.10€
AB030076-03	200	21.70€
AB030076-05	150	18.90€
AB030076-06	150	18.90€
AB030076-07	200	21.60€
AB030076-11	200	24.80€
AB030076-13	200	21.60€
AB030076-14	100	23.20€
AB030076-15	100	23.40€
AB030076-17	100	23.20€
AB030076-18	200	21.70€
AB030076-20	200	22.30€
AB030076-21	100	25.60€
AB030076-24	100	27.20€
AB030076-26	100	27.50€
AB030076-27	100	27.70€
AB030076-28	100	27.70€
AB030076-30	100	23.40€
AB030076-32	100	23.30€
AB030076-34	200	40.10€



AB030076-00 99.20€

Jogo de 21 tipos de molas com 20 peças de cada
Caixa plástica



AB030060 52.40€

Jogo de 2 alicates para molas plásticas



AB030068A 35.60€

Alavanca de chapeiro

Medida: 380mm



AB030068C 44.40€

Alavanca de chapeiro

Medida: 900mm



AB030068D 41.20€

Alavanca de chapeiro

Medida: 750mm



AB030068F 27.30€

Alavanca de chapeiro

Medida: 450mm



AB030069A 31.00€

Cunha de chapeiro

Medida: 125mm



AB030069B 38.40€

Cunha de chapeiro

Medida: 137mm



AB030069E 10.10€

Cunha de chapeiro

Medida: 48mm



AB030094J 11.10€

Cunha de chapeiro

Medida: 84,7mm



AB030070B 28.10€

Encontrador de dupla face



AB030070C 24.40€

Encontrador curvo



AB030070D 37.70€

Encontrador tipo vírgula



AB030089

157.10€

Jogo de 7 encontradores para alumínio em polietileno de alta densidade



AB030100

69.10€

Martelo para alumínio com acessórios



Novo

AB030105

69.60€

Tira mossas com almofadas autocolantes



AB030071

43.50€

Martelo de cabeça redonda serrilhada



M10110

27.30€

Martelo de cabeça plana redonda e pena pontiaguda



M10210A

22.80€

Martelo de cabeça plana redonda e pena curva



M10210B

22.40€

Martelo de cabeça plana redonda e pena direita



Chapeiro

M10410A

29.70€

Martelo de puxar com cabeça redonda plana e quadrada rendilhada picotada



M10410B

31.20€

Martelo de puxar com cabeça redonda plana e quadrada rendilhada normal



AG010024

35.70€

Armação flexível para lima de chapeiro

Para limas de 355mm



AG010024

Lima para AG010024

Ref.	Serra	Compr.	Preço
AG010024-1	9	14"/355mm	34.50€
AG010024-2	12	14"/355mm	40.70€

AG010030A

181.60€

Jogo de martelos e encontradores



AG010185

120.30€

Alicate de rebordear

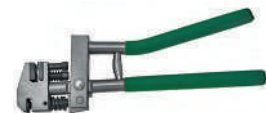

AG010055

29.20€

Desandador de percussão com acessórios



AG010055-B

3.70€

Jogo de 4 bits para AG010055/AG010138

Composição:

Fenda: 8 e 10mm
Philips: PH2 e PH3



AE310003

117.00€

Jogo de tira mossas



Novo

AE310004

284.10€

Jogo extractores



AE330004

76.00€

Pinça de chapeiro uni-direcional

Capacidade: 3t



AE330005

85.80€

Pinça de chapeiro bi-direcional

Capacidade: 2t (transversalmente)
3t (longitudinalmente)



AE330008

68.00€

Pinça de chapeiro bi-direcional

Capacidade: 2t (puxar cruzado)
3t (puxar direito)



AE330009

150.40€

Pinça de chapeiro tipo alicate uni-direcional

Capacidade: 3t



AE330013

148.20€

Pinça de chapeiro bi-direcional

Capacidade: 3t (transversalmente)
5t (longitudinalmente)



AE330015

268.50€

Pinça de chapeiro bi-direcional de 2 pontos

Capacidade: 5t



AE330016

51.80€

Gancho para união de corrente

Capacidade: 6t



AE330030

98.10€

Ponto fixo de puxar

Capacidade: 5t



AE330034

222.90€

Pinça de chapeiro de posição variável até 90°

Capacidade: 5t



AE330035

106.00€

Pinça de chapeiro

Capacidade: 5t



AG010138

25.90€

Desandador de percussão com 13 bits de 36mm

Phillips: PH1; PH2; PH3 e PH4
Fenda: 5; 6; 8; 10 e 12mm
Hexagonais: 4; 5; 6 e 8mm



AG010138-B

9.90€

Jogo de 13 bits para AG010138/AG010055



Chapeiro

AG010140

Encontrador múltiplo



13.70€

AG010141

Punho para chapeiro com pontas intermutáveis



74.10€

AG010142

Martelo para chapeiro com pontas intermutáveis



66.90€

AG010143

Punho com punções e escopros intermutáveis



75.20€

PESADOS

AL010113

Chave de 1/2" para rodar cambota

Aplicação: SCANIA



41.00€

AL010114

Chave de 1/2" para alinhar cambota

Aplicação:

Marca Motorização

MERCEDES 6.8/ 10 cilindros

MAN 12 cilindros



51.30€

AL010116

Chave de 11 dentes para alinhar cambota

Medida: Parafuso hexagonal de 24mm

Aplicação: DAF CF65/ CF75/ CF85/
F65/ F75/ F85/ F95/ XF95



68.10€

AL010117

Chave de 1/2" para alinhar cambota

Aplicação: DAF XF105 euro



37.80€

AN010187

Alicate para cintas de travões

Aplicação: VOLVO



174.90€

AI010153

Chave sensor de posição com 8 faces de 1/2"

Não utilizar com máquinas pneumáticas

Medida: 27mm

Comprimento: 60mm

Aplicação: MERCEDES Actros/ série SK/ MAN/ SCANIA



21.70€

AI020164

Chave para válvula eletromagnética com 8 faces de 3/4"

Medida: 38mm

Comprimento: 100mm

Aplicação: SCANIA



35.10€

AI040245

Chave para rolamentos da cambota de 3/4"

Medida: E28 - Torx

Comprimento: 90mm

Aplicação: SCANIA



29.00€

AI050135

147.10€

Jogo de chaves de copo para filtros - pesados

Composição:

- Chave 6 faces 36mm
- Chave 15 faces 74mm
- Chave 15 faces 106mm
- Chave 15 faces 107mm
- Chave 15 faces 108mm
- Chave 18 faces 108mm
- Chave 18 faces 135mm
- Chave de cinta Ø 160mm
- Chave 21mm



AI050172

205.30€

Chave de filtros ajustável de 1/2"

Medida: 104-150mm



AN010235

76.80€

Chave de 3/4" para instalação/ remoção de fêmea embraiagem

- Diâmetro interno: 64mm
- Diâmetro externo: 79mm
- Comprimento: 78mm
- Espigões: 7mm
- Aplicação: SCANIA



AN010237

139.30€

Extrator para articulações tirante de travões

Haldex



AN04005

Chave para remoção da tampa do cubo da roda traseira

Ref.	Medida (mm)	Preço
AN040055	111	169.40€
AN040056	120	173.80€

AN040062

38.40€

Chave de desmontagem da camisa dos injetores

Aplicação: SCANIA/ MERCEDES/ MAN



AN040066

213.50€

Saca rótulas

Medida: 39mm

Aplicação: SCANIA/ MERCEDES/ MAN/ HINO



AN040105

183.90€

Chave para roda traseira com 8 faces de 1"

Medida: 100mm

Aplicação: SCANIA



AN040200

127.00€

Chave cubo para roda dianteira de 1"

Medida: 80mm

Aplicação: SCANIA





JONNESWAY®

Ferramenta Pneumática



**Ferramenta
pneumática**

**Acessórios
para redes de
ar comprimido**



JAI-1024

211.70€

Máquina compacta de impacto de 1/2"

Caraterísticas:

Rotações em vazio:	10 000rpm
Torque trabalho:	510Nm
Torque máximo:	570Nm
Comprimento:	99mm
Peso:	1 400g
Consumo ar:	127l/min
Pressão de funcionamento:	6,2bar
Ruído:	97dB



JAI-1024-RK

12.30€

Kit de reparação para JAI-1024

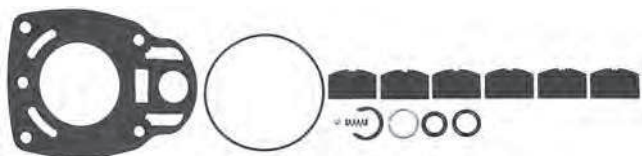

JAI-1124

219.00€

Máquina compacta de impacto de 1/2"

Máquina ultra leve em compósito com mecanismo de 2 percutores e 3 velocidades de aperto e 1 velocidade de desaperto (potência máxima). Cobertura frontal em liga alumínio resistente.

Caraterísticas:

Rotações em vazio:	9 500rpm
Torque trabalho:	560Nm
Torque máximo:	620Nm
Comprimento:	112mm
Peso:	1 150g
Consumo ar:	136l/min
Pressão de funcionamento:	6,2bar
Ruído:	99,9dB



BREAKAWAY

torque **1 100Nm**

JAI-1124-RK

14.50€

Kit de reparação para JAI-1124



JAI-1114

226.20€

Máquina de impacto de 1/2"

Máquina em compósito preparada para trabalho intensivo com mecanismo de 2 percutores.

Caraterísticas:

Rotações em vazio:	9 500rpm
Torque trabalho:	880Nm
Torque máximo:	1 356Nm
Comprimento:	190mm
Peso:	2 300g
Consumo ar:	207l/min
Pressão de funcionamento:	6,2bar
Ruído:	99,2dB



JAI-1114K

300.90€

Máquina pneumática de impacto de 1/2" com kit de chaves

Máquina em compósito preparada com mecanismo de 2 percutores.

Caraterísticas:

Rotações em vazio:	9 500rpm
Torque trabalho:	880Nm
Torque máximo:	1 356Nm
Comprimento:	190mm
Peso:	2 300g
Interior mangueira:	10mmø
Consumo ar:	207l/min
Ruído:	99,2dB



Acessórios:

- 10 Chaves impacto de 1/2": 9; 10; 11; 13; 17; 19; 22; 24 e 27mm
- 1 Extensão de 125mm

JAI-1114-RK

17.30€

Kit de reparação para JAI-1114

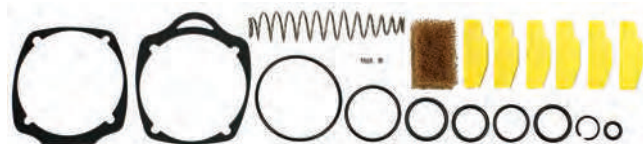

JAI-1524

169.40€

Máquina pneumática de impacto de 1/2"

Máquina em compósito para trabalho intensivo preparada com mecanismo de 2 percutores.

Caraterísticas:

Rotações em vazio:	8 500rpm
Torque trabalho:	840Nm
Torque máximo:	1 080Nm
Comprimento:	190mm
Peso:	2 500g
Interior mangueira:	10mmø
Consumo ar:	125l/min
Ruído:	104,8dB
Posições de aperto:	3
Posições de desaperto:	1

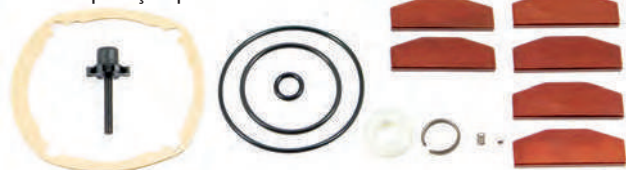

JAI-1524-RK
11.10€
Kit de reparação para JAI-1524

JAI-0954
276.30€
Máquina de impacto de 1/2"

Máquina em compósito preparada com mecanismo de 2 percutores (Twin Hammer).

Características:

Rotações em vazio:	8 500rpm
Torque trabalho:	880Nm
Torque máximo:	1 356Nm
Comprimento:	181mm
Peso:	1 900g

JAI-0954-RK
23.40€
Kit de reparação para JAI-0954

JAI-1232K
195.00€
Máquina para remoção de velas de incandescência de 1/4" com kit de chaves

Máquina com comutador de direção incorporado no botão de acionamento, permitindo efetuar a mudança de direção só com uma mão.

4 Posições reguláveis para 20; 30; 40 e 45Nm

Características:

Rotações em vazio:	11 000rpm
Torque:	20-45Nm
Comprimento:	180mm
Peso:	800g
Consumo ar:	150l/min
Pressão de funcionamento:	6,2bar
Ruído:	102dB

Acessórios:

 Chaves caixa longas: 8; 9; 10; 11 e 12mm
 Cardan
 Extensão

JAI-1232-RK
15.40€
Kit de reparação para JAI-1232

JAI-1054
265.00€
Máquina de impacto de 1/2"

Máquina para trabalho intensivo com mecanismo de 2 percutores.

Características:

Rotações em vazio:	8 000rpm
Torque trabalho:	780Nm
Torque máximo:	920Nm
Comprimento:	186mm
Peso:	2 560g
Interior mangueira:	13mmø
Consumo ar:	119l/min
Ruído:	90dB

JAI-1054-RK
27.30€
Kit de reparação para JAI-1054

JAI-1513
276.30€
Máquina pneumática de impacto angular de 3/8"

Características:

Rotações em vazio:	6 500rpm
Torque trabalho:	339Nm
Torque máximo:	380Nm
Comprimento:	248mm
Peso:	1 350g
Interior mangueira:	10mmø
Consumo ar:	119l/min
Ruído:	105dB

JAI-1513-RK
23.40€
Kit de reparação para JAI-1513

JAI-1514

275.00€

Máquina pneumática de impacto angular de 1/2"

Caraterísticas:

Rotações em vazio:	6 500rpm
Torque trabalho:	407Nm
Torque máximo:	460Nm
Comprimento:	248mm
Peso:	1 400g
Interior mangueira:	10mmø
Consumo ar:	119l/min
Ruído:	105dB



JAI-1514-RK

24.00€

Kit de reparação para JAI-1514

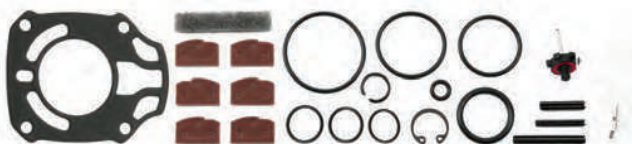

JAI-0926-RK

47.40€

Kit de reparação para JAI-0926



JAI-0936

757.70€

Máquina de impacto de 3/4"

Máquina em compósito preparada para trabalho intensivo com mecanismo de 2 percutores.

Caraterísticas:

Rotações em vazio:	6 500rpm
Torque trabalho:	1 620Nm
Torque máximo:	2 025Nm
Comprimento:	225mm
Peso:	1 940g
Interior mangueira:	13mmø
Consumo ar:	190l/min
Ruído:	90,5dB



JAI-0936-RK

73.50€

Kit de reparação para JAI-0936



JAI-6212K

523.70€

Máquina de impacto de 3/4" com kit de chaves

Máquina com mecanismo pin clutch.

Caraterísticas:

Rotações em vazio:	4 800rpm
Torque máximo:	1 086Nm
Peso:	4 900g
Interior mangueira:	13mmø

Acessórios:

Chaves: 26-38mm
Mala



JAI-6212-RK1

23.40€

Kit de reparação para JAI-6212

JAI-6211

468.00€

Máquina de impacto de 3/4" (19mm)

Máquina com mecanismo de 2 percutores.

Caraterísticas:

Rotações em vazio:	6 500rpm
Torque máximo:	1 016Nm
Peso:	4 550g
Interior mangueira:	13mmø



JAI-6211-RK

45.80€

Kit de reparação para JAI-6211



JAI-1206L

1 002.90€

Máquina de impacto de 3/4"

Máquina para trabalho intensivo com veio longo e mecanismo de 2 percutores.

Caraterísticas:

Rotações em vazio:	5 500rpm
Torque trabalho:	2 100Nm
Torque máximo:	2 300Nm
Comprimento:	465mm
Peso:	6 400g
Interior mangueira:	19mmø
Consumo ar:	212l/min
Ruído:	106dB

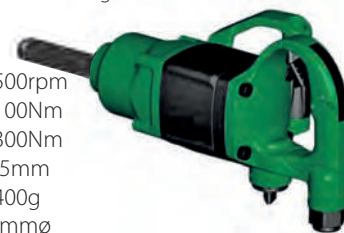

JAI-1206L-RK

68.00€

Kit de reparação para JAI-1206



JAI-0938

846.90€

Máquina de impacto de 1"

Máquina em compósito para trabalho intensivo com mecanismo de 2 percutores.

Caraterísticas:

Rotações em vazio:	6 500rpm
Torque trabalho:	1 740Nm
Torque máximo:	2 150Nm
Comprimento:	230mm
Peso:	4 100g
Consumo ar:	190l/min
Pressão de funcionamento:	6,2bar
Ruído:	190,5dB



JAI-0938-RK

70.20€

Kit de reparação para JAI-0938



JAI-1138

863.60€

Máquina de impacto de 1"

Máquina de veio curto com mecanismo de 2 percutores.

Caraterísticas:

Rotações em vazio:	5 000rpm
Torque trabalho:	2 430Nm
Torque máximo:	2 712Nm
Comprimento:	347mm
Peso:	7 400g
Interior mangueira:	19mmø
Consumo ar:	255l/min
Ruído:	100dB



JAI-1138-RK

105.90€

Kit de reparação para JAI-1138/ JAI-1138L



JAI-1138L

902.60€

Máquina de impacto de 1"

Máquina de veio longo com mecanismo de 2 percutores.

Caraterísticas:

Rotações em vazio:	5 000rpm
Torque trabalho:	2 430Nm
Torque máximo:	2 712Nm
Comprimento:	487mm
Peso:	8 300g
Interior mangueira:	19mmø
Consumo ar:	255l/min
Ruído:	100dB



JAI-1408

1 537.70€

Máquina de impacto pesados de 1"

Máquina de veio curto.

Caraterísticas:

Rotações em vazio:	4 800rpm
Torque trabalho:	3 270Nm
Torque máximo:	3 520Nm
Comprimento:	370mm
Peso:	10 500g
Consumo ar:	450l/min
Pressão de funcionamento:	6,3bar
Ruído:	105,5dB



JAI-1408-RK

101.50€

Kit de reparação para JAI-1408/ JAI-1408L



JAI-1408L

1 582.30€

Máquina de impacto pesados de 1"

Máquina de veio longo.

Caraterísticas:

Rotações em vazio:	4 800rpm
Torque trabalho:	3 270Nm
Torque máximo:	3 520Nm
Comprimento:	570mm
Peso:	11 900g
Consumo ar:	450l/min
Pressão de funcionamento:	6,3bar
Ruído:	105,5dB



JAI-6202-RK

72.40€

Kit de reparação para JAI-6202



JAI-0501-RK

24.50€

Kit de reparação para JAI-0501



JAR-1012

102.50€

Roquete pneumático de 1/4"

Caraterísticas:
 Rotações em vazio: 230rpm
 Torque máximo: 40Nm
 Comprimento: 140mm
 Peso: 469g
 Interior mangueira: 10mmø
 Consumo ar: 338l/min



JAR-1012-RK

37.90€

Kit de reparação para JAR-1012



JAR-1013

101.40€

Roquete pneumático de 3/8"

Caraterísticas:
 Rotações em vazio: 230rpm
 Torque máximo: 40Nm
 Comprimento: 140mm
 Peso: 469g
 Interior mangueira: 10mmø
 Consumo ar: 338l/min



JAR-1013-RK

37.90€

Kit de reparação para JAR-1013



JAR-1094

135.50€

Roquete pneumático de 1/2"

Caraterísticas:
 Rotações em vazio: 170rpm
 Torque máximo: 100Nm
 Comprimento: 275mm
 Peso: 1 400g
 Interior mangueira: 10mmø
 Consumo ar: 113l/min
 Ruído: 87dB



JAR-1094-RK

41.20€

Kit de reparação para JAR-1094



JAR-6309AK

163.80€

Roquete pneumático de 1/2" com kit de chaves

Caraterísticas:
 Rotações em vazio: 170rpm
 Torque máximo: 100Nm
 Comprimento: 275mm
 Peso: 1 400g
 Interior mangueira: 10mmø



Acessórios:

Chaves: 9; 10; 11; 13; 14; 17 e 19mm
 Extensão: 75mm
 União universal de 1/2"
 Bits e porta bits
 Mala



JAR-6309A-RK

33.40€

Kit de reparação para JAR-6309A



JAR-6310A

117.00€

Roquete pneumático de 3/8"

Caraterísticas:
 Rotações em vazio: 170rpm
 Torque máximo: 100Nm
 Comprimento: 275mm
 Peso: 1 300g
 Interior mangueira: 10mmø



JAR-6310A-RK
32.30€
Kit de reparação para JAR-6310A

JAR-6310AK
161.60€
Roquete pneumático de 3/8" com kit de chaves

Caraterísticas:
 Rotações em vazio: 170rpm
 Torque máximo: 100Nm
 Comprimento: 275mm
 Peso: 1 300g
 Interior mangueira: 10mmø



Acessórios:

Chaves: 9; 10; 11; 13; 14; 17 e 19mm
 Extensão: 75mm
 União universal de 3/8"
 Bits e porta bits
 Mala

JAR-1033
356.60€
Roquete pneumático combinado de 3/4" com kit de chaves

Caraterísticas:
 Rotações em vazio: 180rpm
 Torque máximo: 107Nm
 Comprimento: 9,5mm
 Peso: 1 400g
 Interior mangueira: 10mmø



Acessórios:

Chaves: 8 a 19mm
 Adaptadores

JAR-1033-RK
89.10€
Kit de reparação para JAR-1033A

JAD-0212
131.50€
Berbequim pneumático de 1/4"

Máquina em compósito.

Caraterísticas:
 Rotações em vazio: 1 800rpm
 Potência: 2cv
 Comprimento: 199mm
 Peso: 780g
 Interior mangueira: 10mmø
 Consumo ar: 54,4l/min
 Ruído: 97dB

JAD-0212-RK
11.40€
Kit de reparação para JAD-0212

JAD-0413
133.70€
Berbequim reversível pneumático de 3/8"

Caraterísticas:
 Rotações em vazio: 1 800rpm
 Motor: 0,4cv
 Capacidade da bucha: 10mm
 Comprimento: 210mm
 Peso: 950g
 Interior mangueira: 10mmø
 Consumo ar: 99l/min
 Vibração: 3,3m/s²
 Ruído: 80dB

JAD-0413-RK
13.90€
Kit de reparação para JAD-0413

JAD-0534
366.60€
Berbequim pneumático de 1/2"

Caraterísticas:
 Potência: 0,6cv
 Rotações em vazio: 7 000rpm
 Comprimento: 240mm
 Peso: 1 400g
 Consumo de ar: 113 l/m
 Ruído em carga: 97 dB

JAD-0534-RK
104.50€
Novo

JAD-1020

123.10€

Berbequim reversível pneumático de 1/2"

Caraterísticas:

Rotações em vazio: 800rpm
 Capacidade da bucha: 13mm (aperto com chave)
 Comprimento: 220mm
 Peso: 1 300g
 Interior mangueira: 10mmø



JAD-1020-RK

2.80€

Kit de reparação para JAD-1020



JAD-1021

140.40€

Berbequim pneumático angular de 3/8"

Caraterísticas:

Rotações em vazio: 1 900rpm
 Capacidade da bucha: 10mm (aperto com chave)
 Comprimento/ altura: 190x110mm
 Peso: 960g
 Interior mangueira: 10mmø
 Consumo ar: 280l/min



JAD-1021-RK

15.50€

Kit de reparação para JAD-1021



JAD-1027

156.00€

Berbequim reversível pneumático de 1/2"

Caraterísticas:

Rotações em vazio: 800rpm
 Capacidade da bucha: 13mm (aperto sem chave)
 Comprimento: 178mm
 Peso: 1 820g
 Interior mangueira: 10mmø



JAD-1027-RK

2.70€

Kit de reparação para JAD-1027



JAD-6252A

81.30€

Berbequim pneumático de 3/8"

Caraterísticas:

Rotações em vazio: 2 500rpm
 Capacidade da bucha: 9,5mm (aperto com chave)
 Comprimento: 228mm
 Peso: 900g
 Interior mangueira: 10mmø



JAD-6252A-RK

4.50€

Kit de reparação para JAD-6252



JAB-1017

122.60€

Aparafusadora pneumática reversível de 1/4"

Caraterísticas:

Rotações em vazio: 1 800rpm
 Capacidade da bucha: 1/4"
 Comprimento: 190mm
 Peso: 1 100g
 Interior mangueira: 10mmø



JAB-1017-RK

2.30€

Kit de reparação para JAB-1017

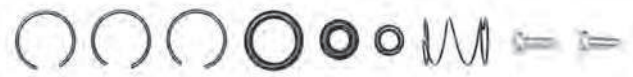

JAB-1018

139.30€

Aparafusadora pneumática reversível de 1/4"

Caraterísticas:

Rotações em vazio: 800rpm
 Capacidade da bucha: 1/4"
 Comprimento: 226mm
 Peso: 1 300g
 Interior mangueira: 10mmø



JAB-1018-RK

2.30€

Kit de reparação para JAB-1018



JAB-7003A
144.90€
Aparafusadora pneumática reversível de 1/4"
Caraterísticas:

Rotações em vazio: 1 800rpm
 Capacidade da bucha: 1/4"
 Comprimento: 254mm
 Peso: 1 140g
 Interior mangueira: 10mmø

JAB-7003A-RK
5.10€
Kit de reparação para JAB-7003A

JAD-1015K
392.00€
Máquina pneumática de descraçar pontos com kit de acessórios
Caraterísticas:

Rotações em vazio: 1 800rpm
 Capacidade de furo: 8mm
 Comprimento: 254mm
 Peso: 2 100g
 Interior mangueira: 10mmø

Acessórios:

Chave hexagonal: 2,5mm
 Brocas
 Lubrificador
 Ligador: 1/4"x1/4"
 Mala

JAD-1015-RK
2.90€
Kit de reparação para JAD-1015K

JAZ-7207
94.70€
Jogo de 5 brocas para máquina descraçar

Aplicável aos modelos: JAD-1015/ JAD-6246

Caraterísticas:

Brocas em HSS e cobalto
 Diâmetro: 6,5mmø

JAG-0903-MS
17.00€
Jogo de 10 buris

Aplicável aos modelos:

JAG-0903/ JAG-0906/ JAG-0913/ JAG-0923/ JAG-0925/ JAG-0955

JAG-0906RMK
101.50€
Retificadora pneumática de 1/4" com kit de acessórios
Caraterísticas:

Rotações em vazio: 22 000rpm
 Capacidade da pinça: 6mm
 Potência: 0,4Kw
 Comprimento: 175mm
 Peso: 490g
 Interior mangueira: 10mmø

Acessórios:

Buris: 6mm (1/4")
 Buris: 3mm (1/8")
 Chaves
 Redução: 3mm (1/8")
 Mala

JAG-0906R/RM-RK
9.00€
Kit de reparação para JAG-0906RMK

JAG-0913RMK
125.00€
Retificadora pneumática angular de 1/4" com kit acessórios
Caraterísticas:

Rotações em vazio: 18 000rpm
 Capacidade da pinça: 6mm
 Potência: 0,21Kw
 Comprimento: 155mm
 Peso: 490g
 Interior mangueira: 10mmø

Acessórios:

Buris: 6mm (1/4")
 Buris: 3mm (1/8")
 Chaves
 Redução: 3mm (1/8")
 Mala

JAG-0913RM-RK
6.20€
Kit de reparação para JAG-0913RMK

JAG-0923RM

60.20€

Mini retificadora pneumática de 1/4"

Caraterísticas:

Rotações em vazio:	25 000rpm
Capacidade da pinça:	6mm
Potência:	0,5hp
Comprimento:	170mm
Peso:	700g
Consumo ar:	76l/min
Pressão de funcionamento:	6,2bar
Ruído:	97dB



JAG-0923RM-RK

7.10€

Kit de reparação para JAG-0923RM



JAG-0925RM

63.50€

Retificadora pneumática de 1/4"

Caraterísticas:

Rotações em vazio:	22 000rpm
Capacidade da pinça:	6mm
Potência:	0,5hp
Comprimento:	170mm
Peso:	700g
Consumo ar:	113l/min
Pressão de funcionamento:	6,2bar
Ruído:	97dB



JAG-0925RM-RK

21.70€

Kit de reparação para JAG-0925RM



JAG-0955RM

100.30€

Retificadora pneumática de 1/4"

Caraterísticas:

Rotações em vazio:	22 000rpm
Capacidade da pinça:	6mm
Potência:	0,5hp
Comprimento:	260mm
Peso:	700g
Consumo ar:	113l/min
Pressão de funcionamento:	6,2bar
Ruído:	97dB



JAG-0955RM-RK

8.50€

Kit de reparação para JAG-0955RM



JAG-1087

174.90€

Micro retificadora pneumática

Caraterísticas:

Rotações em vazio:	60 000rpm
Bucha:	3mm
Interior mangueira:	10mmø
Peso:	220g
Consumo ar:	180l/min
Dimensões:	17x120mm



JAG-1087-RK

34.50€

Kit de reparação para JAG-1087



JAG-6638

190.10€

Rebarbadora pneumática angular de 125mm

Caraterísticas:

Rotações em vazio:	11 000rpm
Dimensão do disco:	125mm
Potência:	0,7Kw
Comprimento:	230mm
Peso:	1 800g
Interior mangueira:	10mmø
Vibração do punho:	6,45m/s ²
Ruído:	86dB



JAG-6638-RK

78.00€

Kit de reparação para JAG-6638



JAG-6638-DC

2.10€

Disco de corte

Medida: 125mm

JAG-6638-DR

3.60€

Disco de rebarbar

Medida: 125mm

JAG-6639

356.60€

Rebarbadora pneumática angular de 180mm

Caraterísticas:

Rotações em vazio:	7 000rpm
Dimensão do disco:	180mm (7")
Potência:	1,4Kw
Comprimento:	343mm
Peso:	3 100g
Interior mangueira:	10mmø



JAG-6639-RK

105.90€

Kit de reparação para JAG-6639



JAG-6639-DC

3.60€

Disco de corte

Medida: 180mm

JAG-6639-DR

6.10€

Disco de rebarbar

Medida: 180mm

JAS-6505

198.80€

Lixadora de disco de 180mm

Caraterísticas:

Rotações em vazio: 4 500rpm
 Dimensão do disco: 178mm
 Rosca do veio: 5,8" (11UNC)
 Comprimento: 406mm
 Peso: 2 500g
 Interior mangueira: 10mmø



JAS-6505-RK

7.00€

Kit de reparação para JAS-6505



JAS-6551

192.80€

Lixadora de disco de 180mm

Caraterísticas:

Rotações em vazio: 2 500rpm
 Dimensão do disco: 178mm
 Rosca do veio: 5,8" (11UNC)
 Comprimento: 406mm
 Peso: 2 500g
 Interior mangueira: 10mmø



JAS-6551-RK

6.90€

Kit de reparação para JAS-6551



JAS-6552

196.00€

Polidora pneumática de 180mm

Caraterísticas:

Rotações em vazio: 2 500rpm
 Dimensão do disco: 178mm
 Peso: 2 800g
 Interior mangueira: 10mmø
 Consumo ar: 260l/min



JAS-6552-RK

22.30€

Kit de reparação para JAS-6552



JAS-0010

284.10€

Lixadora com base triangular em vinil

Caraterísticas:

Rotações em vazio: 9 000rpm
 Dimensão da base: 93x132mm
 Interior mangueira: 10mmø
 Consumo ar: 260l/min



JAS-0010-RK

26.20€

Kit de reparação para JAS-0010



JAS-0010-41

23.40€

Base para lixadora JAS-0010

Dimensão da base: 93x132mm



JAS-0413

146.30€

Lixadora orbital angular

Máquina em compósito

Caraterísticas:

Rotações em vazio: 15 000rpm
 Dimensão do disco: 76mm
 Órbita: 3mm
 Motor: 0,4cv
 Comprimento: 125mm
 Peso: 720g
 Interior mangueira: 10mmø
 Consumo ar: 99l/min
 Vibração: 6,3m/s²
 Ruído: 80dB



JAS-0413-RK

12.30€

Kit de reparação para JAS-0413



JAS-0423K

190.00€

Polidora angular

Máquina em compósito

Caraterísticas:

- Rotações em vazio: 2 100rpm
- Dimensão do disco: 76mm
- Motor: 0,4cv
- Comprimento: 135mm
- Peso: 770g
- Consumo ar: 99l/min
- Pressão de funcionamento: 6,2bar
- Vibração: 2,3m/s²
- Ruído: 78dB



JAS-0423-RK

27.30€

Kit de reparação para JAS-0423

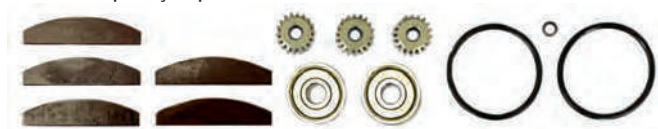

JAS-0423-31

13.40€

Base em velcro para JAS-0423



JAS-1021-6HE(2.5)

247.40€

Lixadora orbital angular com base em vinil aderente com 6"

Máquina em compósito

Caraterísticas:

- Rotações em vazio: 12 000rpm
- Dimensão do disco: 150mm
- Órbita: 2,5mm
- Peso: 960g
- Interior mangueira: 10mmø
- Consumo ar: 170l/min



JAS-1021-6HE-RK

11.70€

Kit de reparação para JAS-1021-6HE



JAS-1206-6HE

390.00€

Lixadora orbital para ligação a central de aspiração com base em vinil aderente com 6"

Máquina em compósito

Caraterísticas:

- Rotações em vazio: 12 000rpm
- Dimensão do disco: 150mm
- Órbita: 5mm
- Interior mangueira: 10mmø



JAS-1206-6HE-RK

52.40€

Kit de reparação para JAS-1206-6HE



JAS-1206-6HP

59.10€

Base com velcro para lixadora JAS-1206/ JAS-1207 com 6"



JAS-1207-6HE

434.60€

Lixadora orbital com auto aspiração com base em vinil aderente com 6"

Máquina em compósito

Caraterísticas:

- Rotações em vazio: 12 000rpm
- Dimensão do disco: 150mm
- Órbita: 5mm
- Interior mangueira: 10mmø
- Saco para recolha de pó



JAS-1207-6HE-RK

52.40€

Kit de reparação para JAS-1207-6HE



JAS-1207-6HE-56

32.30€

Saco em tecido para proteção do saco papel de recolha de pó para JAS-1207-6HE.



JAS-1207-6HE-57 4.00€

Saco em papel para recolha de pó para JAS-1207-6HE

JAS-1206-6HP 59.10€

Base com velcro para lixadora JAS-1206/ JAS-1207 com 6"

JAS-1031-6HE 254.00€

Lixadora orbital com base em velcro com 6"

Máquina em compósito

Características:

Rotações em vazio:	10 000rpm
Dimensão do disco:	150mm
Órbita:	5mm
Peso:	1 040g
Interior mangueira:	10mmø

JAS-1031-6HE-RK 56.80€

Kit de reparação para JAS-1031-6HE

JAS-1031-6VE-RK 55.70€

Kit de reparação para JAS-1031-6VE

JAS-1031-6HP 27.90€

Base em velcro para lixadora JAS-1031/ JAS 6535-6HE

JAS-6531 163.80€

Lixadora retangular estreita

Máquina em compósito

Características:

Movimentos/ minuto:	2 500
Dimensão da base:	63,5x407mm
Comprimento:	406mm
Peso:	3 100g
Interior mangueira:	10mmø
Consumo ar:	226l/min
Ruído:	93,3dB

JAS-6531-RK 3.50€

Kit de reparação para JAS-6531

JAS-6531-LIXA 56.20€

Rolo de lixa tela flexível

JAS-6535-5HE 228.40€

Lixadora orbital com base em velcro com 5"

Máquina em compósito

Características:

Rotações em vazio:	10 000rpm
Dimensão do disco:	125mm
Órbita:	5mm
Peso:	1 040g
Interior mangueira:	10mmø

JAS-6535-5HE-RK 59.10€

Kit de reparação para JAS-6535-5HE

JAS-6535-5HE-47 23.40€

Base em velcro para JAS-6535-5HE

JAS-6535-5VE-RK 43.50€

Kit de reparação para JAS-6535-5VE

JAS-6535-6HE 228.40€

Lixadora orbital com base em velcro com 6"

Máquina em compósito

Características:

Rotações em vazio:	10 000rpm
Dimensão do disco:	150mm
Órbita:	5mm
Peso:	1 040g
Interior mangueira:	10mmø

JAS-6535-6HE-RK 55.70€

Kit de reparação para JAS-6535-6HE

JAS-1031-6HP 27.90€

Base em velcro para lixadora JAS-1031/ JAS 6535-6HE



JA-6111(1.4)

131.20€

Pistola de pintura tipo gravidade

Caraterísticas:

Entrada ar: 1/4"
Capacidade copo nylon: 600ml
Bico standard: 1,4mm



JA-6111

Kit de bico para pistola JA-6111

Ref.	Medida (mm)	Preço
JA-6111-NS13	1.3	52.20€
JA-6111-NS17	1.7	50.10€
JA-6111-NS20	2	50.10€



JA-6111K

280.40€

Jogo de pistola de pintura tipo gravidade e acessórios

Caraterísticas:

Pistola: JA-6111
Capacidade copo nylon: 250 e 600 ml
Bicos: 1,7 e 2mm
Interior mangueira: 10mmø
Kit de limpeza
Mala



JA-HVLP-1080GK

341.20€

Jogo de pistola de pintura HVLP e acessórios

Caraterísticas:

Pistola: JA-HVLP-1 080G
Capacidade copo nylon: 250 e 600ml
Bicos: 1,4; 1,7 e 2mm
Interior mangueira: 10mmø
Kit de limpeza
Mala



JA-HVLP-1080GD-N1.4

69.70€

Bico de 1.4 para pistola JA-HVLP-1 080GD



JA-HVLP-300C (1.3)

208.80€

Pistola de pintura tipo gravidade

Caraterísticas:

Entrada ar: 1/4"
Capacidade copo nylon: 600 ml
Bico standard: 1,3mm
Pressão ar: 2bar
Consumo ar: 481l/min
Peso: 545g
Interior mangueira: 10mmø



JA-HVLP-3000-NS17

80.20€

Kit bico 1.7 para pistola de pintura

JA-HVLP-3000-NS19

80.20€

Kit bico 1.9 para pistola de pintura

JA-300C-NS13

79.10€

Bico completo 1.3 para pistola de pintura JA-HVLP3000/ JA-HVLP300C

JA-LVLP-0303W

218.80€

Pistola de pintura para tintas à base de água tipo gravidade

Caraterísticas:

Entrada ar: 1/4"
Capacidade copo nylon: 600ml
Bico standard: 1,3mm
Interior mangueira: 10mmø



JA-LVLP-0303W-N

64.60€

Kit bico 1.3 para pistola de pintura



JA-LVLP-0303W-N18

64.60€

Kit bico 1.8 para pistola de pintura

JA-HVLP-6112

195.00€

Pistola de pintura tipo gravidade

Caraterísticas:

Entrada ar: 1/4"
Capacidade copo nylon: 125ml
Bico standard: 1mm
Pressão ar: 3bar
Consumo ar: 112l/min
Peso: 240g
Interior mangueira: 10mmø



ACC-609

25.60€

Regulador de ar 0-10 bar

JA-3806C

13.50€

 Regulador de pressão para pistola de pintura
 Aplicável à pistola JA-HVLP-6112

JA-3808A

13.20€

Separador de óleo/ água para pistolas de pintura

JA-0001RK

6.70€

Kit de reparação para pistola de pintura

AS-0026

17.30€

Kit de limpeza para pistolas de pintura com 12 peças

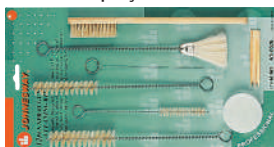
AS-0013A2

31.80€

Copo de alumínio para pistola de pintura tipo gravidade

Capacidade: 600ml

AS-001

Copo para pistola de pintura

Ref.	Capacidade (ml)	Preço
AS-0013	600	17.30€
AS-0015	125	11.30€



Ferramenta pneumática

JA-300C-28

16.30€

Copo para pistola de pintura JA-HVLP-3000

 Capacidade: 600ml
 Tampa não incluída

AS-001

Tampa para copo de pistola de pintura

Ref.	Capacidade (ml)	Preço
AS-0013C	600	5.00€
AS-0015C	250	5.00€

JA-950

88.60€

Pistola de secagem para tintas à base de água

JA-950-04

3.90€

Filtro de rede para pistola JA-950

JA-960

245.10€

Suporte para 2 pistolas de secagem

Não inclui as pistolas

JAS-0452

230.00€

Lixadora de faixa larga

Máquina em compósito

Características:

rotações em vazio:	16 000rpm
Dimensão da base:	20x520mm
Comprimento:	430mm
Peso:	1 400g
Interior mangueira:	10mmø
Consumo ar:	113l/min
Vibração:	2,8m/s ²
Ruído:	95dB



JAS-0452-RK 44.00€

Kit de reparação para JAS-0452

JAS-6542 228.40€

Lixadora de faixa larga

Caraterísticas:

Rotações em vazio: 16 000rpm
 Dimensão da base: 20x520mm
 Comprimento: 360mm
 Peso: 1 200g
 Interior mangueira: 10mmø



JAS-6542-RK 31.20€

Kit de reparação para JAS-6542

JAS-6543 140.20€

Lixadora de faixa estreita

Caraterísticas:

Rotações em vazio: 16 000rpm
 Dimensão da base: 10x330mm
 Comprimento: 290mm
 Peso: 800g
 Interior mangueira: 10mmø



JAS-6543-RK 25.70€

Kit de reparação para JAS-6543

JAT-1020K 317.60€

Serra/ lima pneumática de baixa vibração com kit de acessórios

Mecanismo de baixa vibração

Caraterísticas:

Oscilação por minuto: 16 000bpm
 Curso: 25mm
 Peso: 960g
 Interior mangueira: 10mmø



Acessórios:

Lâminas: T14; T18 e T24
 Limas
 Mala



JAT-1020-RK 69.10€

Kit de reparação para JAT-1020

JAT-12F

Limas para JAT-1020

Ref.	Forma	Preço
JAT-12F1	triangular	7.60€
JAT-12F2	meia cana	7.80€
JAT-12F3	redonda	7.60€
JAT-12F4	chata	7.10€



JAT-20T

Serras para JAT-1020

Ref.	Dentes	Preço
JAT-20T14	14	5.20€
JAT-20T18	18	5.20€
JAT-20T24	24	5.20€



JAT-1041 200.60€

Assentador pneumático de válvulas

Caraterísticas:

Oscilação por minuto: 3 000bpm
 Capacidade máxima: 4,5mmø
 Comprimento: 153,5mm
 Peso: 1 550g
 Interior mangueira: 10mmø
 Consumo ar: 100l/min
 Ventosas: 16; 20; 30 e 35mm



JAT-1041-16S 26.70€

Jogo de 4 ventosas para JAT-1041

Caraterísticas:

Medidas: 16; 20; 30 e 35mm



JAT-1011 178.30€

Serra pneumática de baixa vibração

Caraterísticas:

Oscilação por minuto: 11 000bpm
 Curso: 8mm
 Peso: 450g
 Interior mangueira: 10mmø
 Consumo ar: 90l/min
 Ruído: 86,8dB



JAT-1011-RK 30.60€

Kit de reparação para JAT-1011

JAT-6613 234.00€

Máquina pneumática de decapar

Características:

Diâmetro base: 105mm
 Rotações em vazio: 3.500rpm
 Entrada ar: 1/4"
 Dimensões (comp/alt): 203x106mm
 Peso: 960g
 Consumo ar: 280l/min
 Ruído: 98dB

JAT-6613-P 17.60€

Disco de borracha para JAT-6613

JAT-6613-PA 18.80€

Disco abrasivo de limpeza para JAT-6613

JAT-6613-RK 31.80€

Kit de reparação para JAT-6613
JAT-6676 148.20€

Serra pneumática

Características:

Capacidade de corte: 1,6mm (espessura aço)
 Oscilação por minuto: 10 000bpm
 Curso: 10mm
 Comprimento: 235mm
 Peso: 960g
 Interior mangueira: 10mmø

JAT-6676-RK 8.40€

Kit de reparação para JAT-6676
JAT-10T
Serras para JAT-6676 5 unidades

Ref.	Dentes	Compr. (mm)	Preço
JAT-10T18	18	75	17.30€
JAT-10T32	32	75	17.70€



JAT-6421 55.70€

Máquina de corte pneumática de discos com 3"

Características:

Rotações em vazio: 20 000rpm
 Peso: 1 040g
 Interior mangueira: 10mmø

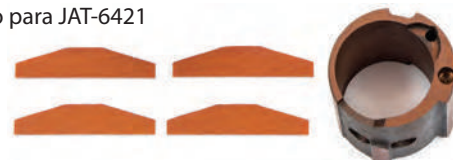
JAT-6421-RK 3.00€

Kit de reparação para JAT-6421

JAT-6421-33 2.30€

Disco de serra para JAT-6421
JAT-6441K 161.00€

Faca pneumática com kit de acessórios

Características:

Oscilação por minuto: 22 000bpm
 Comprimento: 120mm
 Peso: 1 200g
 Interior mangueira: 10mmø



Acessórios:

Lâminas: 30; 35 e 57mm
Mala

JAT-6441-RK 2.20€

Kit de reparação para JAT-6441
CF-K
Lâminas para JAT-6441K

Ref.	Compr. (mm)	Preço
CF-K-C	35	13.30€
CF-K-E	57	10.00€
CF-K-F	90	26.30€
CF-K-G	24	15.00€
CF-K-I	36	19.50€
CF-K-J	63	22.30€



JAT-6443K

200.60€

Ferramenta de corte por oscilação

Caraterísticas:

Amplitude de corte: 3mm
 Potência: 0,3cv
 Oscilação por minuto: 20 000bpm
 Comprimento: 180mm
 Peso: 700g
 Consumo de ar: 54l/m
 Ruído em carga: 95dB



Acessórios:

8 acessórios de corte

JAT-6443-RK

15.60€

Kit de reparação para JAT-6443



JAT-6443-K

Acessórios de corte para JAT-6443

Ref.	Tipo lâmina	Compr. (mm)	Preço
CF-K-E	Corte	57	10.00€
JAT-6443-K1	Corte nivelado	10	6.40€
JAT-6443-K2	Corte nivelado	20	6.40€
JAT-6443-K3	Corte nivelado	30	7.20€
JAT-6443-K4	Raspadora	51	6.40€
JAT-6443-K5	Lixadora triangular	80	8.70€
JAT-6443-K6	HSS meia lua	88	25.60€
JAT-6443-K7	Meia lua rebarbar	64	12.80€



JAT-6952

109.70€

Tesoura pneumática direita

Caraterísticas:

Oscilação por minuto: 2 300/ 2 500bpm
 Capacidade de corte: 1,2mm (espessura aço)
 Tamanho do corte: 5,5mm
 Comprimento: 255mm
 Peso: 1 000g
 Interior mangueira: 10mmø



Acessórios:

Lâminas: 30; 35 e 57mm

JAT-6952-RK

2.20€

Kit de reparação para JAT-6952

JAT-6952P

122.60€

Tesoura pneumática

Caraterísticas:

Oscilação por minuto: 2 200bpm
 Capacidade de corte: 1,2mm (espessura aço)
 Tamanho do corte: 5,5mm
 Comprimento: 215mm
 Peso: 1 200g
 Interior mangueira: 10mmø



JAT-6952P-RK

2.20€

Kit de reparação para JAT-6952P

JAT-6952P

Lâminas para JAT-6952/P

Ref.	Lâmina	Preço
JAT-6952P-37	esquerda	12.30€
JAT-6952P-39	central	14.50€
JAT-6952P-40	direita	12.30€

JAT-6943A

139.50€

Alicate pneumático de rebaixos

Caraterísticas:

Capacidade de corte: 1,4mm
 Capacidade de rebaixo: 8mm
 Quinagem: 12mm
 Comprimento: 248mm
 Peso: 1 300g
 Interior mangueira: 10mmø



JAT-6943A-RK

10.40€

Kit de reparação para JAT-6943A

JAT-6412

84.70€

Reboredadora pneumática

Caraterísticas:

Velocidade de corte: 3 200rpm
 Capacidade de corte: 1,4mm (espessura aço)
 Comprimento: 210mm
 Peso: 1 000g
 Interior mangueira: 10mmø



JAT-6412-RK

2.20€

Kit de reparação para JAT-6412

JAH-0288 132.60€

Martelo pneumático de agulhas

Caraterísticas:
 Pancadas por minuto: 5 000
 Número de agulhas: 12
 Comprimento: 290mm
 Peso: 1 200g
 Consumo ar: 90l/min
 Interior mangueira: 10mmø

JAH-0288-15 17.00€

Cinzel para JAH-0288
JAH-0288-16 8.80€

Jogo de agulhas para JAH-0288
JAH-0288-17 6.90€

Alojamento de agulhas para JAH-0288
JAH-0288-RK 28.40€

Kit de reparação para JAH-0288
JAH-308HK 209.50€

Martelo pneumático de baixa vibração

Caraterísticas:
 Encaixe hexagonal
 Curso do pistão: 64mm
 Golpes por minuto: 3 000
 Comprimento: 230mm
 Peso: 2 000g
 Consumo de ar: 170l/m



Acessórios:
 5 acessórios
 Mala

JAH-308H-RK 8.40€

Kit de reparação para JAH-308H

JAH-6837 180.50€

Martelo burilador direito

Caraterísticas:
 Golpes por minuto: 4 600
 Encaixe: 25,4x43,5
 Comprimento: 380mm
 Peso: 2 100g
 Interior mangueira: 10mmø

JAH-6837-RK 23.40€

Kit de reparação para JAH-6837
JAH-6837-5
Cinzel para JAH-6837

Ref.	Tipo	Compr. (mm)	Preço
JAH-6837-50	plano	35-175	20.60€
JAH-6837-50-2	ponteiro		23.30€

JAH-7104H

460.00€

Martelo pneumático de 1"

Caraterísticas:
 Golpes por minuto: 2 820
 Comprimento: 308mm
 Peso: 5 500g
 Consumo ar: 228l/min
 Interior mangueira: 10mmø

JAH-7104H-RK

7.20€

Kit de reparação para JAH-7104H
JAZ-01
Buril hexagonal

Ref.	Tipo	Preço
JAZ-011H	bico	25.60€
JAZ-016H	ponta	25.60€

JAT-6034

137.10€

Rebitadora pneumática

Caraterísticas:
 Capacidade: 2,4 a 4,8mm (aço+aço inox)
 Potência tração: 10 250Nm
 Curso: 16mm
 Comprimento: 308mm
 Peso: 1 500g
 Interior mangueira: 10mmø

JAT-6034-RK

34.50€

Kit de reparação para JAT-6034

JAT-6034
Bicos para rebitadora JAT-6034

Ref.	Diâmetro (mm)	Preço
JAT-6034-1A	4,8	1.40€
JAT-6034-1B	4	1.40€
JAT-6034-1C	3,2	1.40€
JAT-6034-1D	2	1.40€



JAT-6673

405.00€

Rebitadora pneumática

Caraterísticas:
 Capacidade: 2,4 a 6,4mm (aço+aço inox)
 Curso: 18mm
 Peso: 1 750g
 Consumo ar: 2,9l/ciclo
 Interior mangueira: 10mmø



JAT-6673-RK

66.30€

Kit de reparação para JAT-6673

JAT-1035

591.00€

Rebitadora pneumática de fêmeas

Caraterísticas:
 Dimensões: 270x190mm
 Capacidade: M4-M10 (aço)
 Capacidade: M4-M8 (aço inox)
 Curso: 6mm
 Peso: 1 550g
 Consumo ar: 1,5l/ciclo
 Interior mangueira: 10mmø



JAT-1035-RK

8.70€

Kit de reparação para JAT-1035

JAT-460

37.20€

Bomba de massa manual de ponteira rígida

Acionamento por alavanca
 Capacidade: 400cc



JAT-481

54.00€

Bomba de massa manual de ponteira flexível

Acionamento por pistoleta
 Capacidade: 400cc

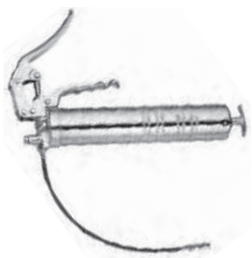

JAT-480-NS

12.90€

Ponteira flexível para JAT-480

Compatível com JAT-460



JAT-6004K

88.90€

Bomba de massa pneumática de ponteira rígida com acessórios

Acionamento por pneumático
 Capacidade: 400cc

Acessórios:



Ponteira flexível
 Alavanca por acionamento manual

JAT-501

72.40€

Pistola pneumática para mastique

Caraterísticas:
 Entrada: 1/4"
 Capacidade: 310ml
 Pressão: 2,5 a 5,1bar
 Interior mangueira: 10mmø
 Cartucho tipo "Salsichão"



JA-5032

41.20€

Pistola pneumática para mastique

Caraterísticas:
 Pressão: 2 a 4bar
 Comprimento: 330mm
 Peso: 1 225g
 Consumo ar: 170l/min
 Interior mangueira: 10mmø
 Material: metal



JAZ-3811E

74.70€

Balaceiro

Caraterísticas:
 Capacidade de carga: 3 a 5kg
 Comprimento do fio: 1,5mt
 Diâmetro do fio: 3,2mm



JA-3812A

48.00€

Balaceiro

Caraterísticas:
 Capacidade de carga: 0,5 a 1,2kg
 Comprimento do fio: 1,6m
 Diâmetro do fio: 1,8mm
 Peso: 560g



JA-3812D

50.00€

Balaceiro

Caraterísticas:
 Capacidade de carga: 1 a 2kg
 Comprimento do fio: 1,6m
 Diâmetro do fio: 1,8mm
 Peso: 560g



JAT-6904S

21.20€

Pistolete para água com kit de acessórios com 5 bicos

JAT-6905B

20.10€

Pistolete de ar

JAT-6905S

39.70€

Pistolete de ar com conjunto de acessórios

JAT-6905-C

3.80€

 Bico para pistolete de ar
Bico triangular espalmado

JAT-6905-J

14.00€

 Bico para pistolete de ar
Bico com escova em nylon

JAT-6959

7.60€

Pistola para ar de bico longo de 1/4"

 Comprimento: 100mm
Pressão trabalho: 75-120psi
Ruído: 85-90dba
Fêmea: 1/4"

JAT-6959A

9.20€

Pistola para ar de bico longo de 1/4"

 Comprimento: 280mm
Pressão trabalho: 75-120psi
Ruído: 85-90dba
Fêmea: 1/4"

Acessórios para redes de ar comprimido

JAZ-000

Enrolador ar

Ref.	Mangueria ø (mm)	Mangueria compri.(m)	Preço
JAZ-0001B	8x12	15	167.10€
JAZ-0002A	8x12	9	123.70€
JAZ-0002B	9,5x13,3	7,5	115.90€
JAZ-0002C	6,5x10	10	122.60€

JAZ-39520

243.20€

Enrolador móvel para ar de 3/8"

 Comprimento: 20m
Pressão máxima: 15bar
Peso: 7 000g
Interior mangueria: 9,5mmø
Ligação: 3/8"

JA-725

Mini lubrificador óleo para máquinas pneumáticas

Ref.	Medida	Preço
JA-7253	1/4"	9.30€
JA-7254	3/8"	12.80€

JAZ-0042

17.80€

Cardan para máquinas pneumáticas 1/4"

JAZ-0513

Copo plástico para filtros lubrificadores JAZ-0512/ JAZ-0513

Ref.	Especif.	Preço
JAZ-0514-06	purga	2.80€
JAZ-0513-09	copo ar	6.40€
JAZ-0514-13	freio	0.40€
JAZ-0513-50	óleo	5.80€

JAZ-0514

Copo plástico para filtros lubrificadores JAZ-0514/ JAZ-0516

Ref.	Especif.	Preço
JAZ-0514-06	purga	2.80€
JAZ-0514-09	copo ar	11.50€
JAZ-0514-13	freio	0.40€
JAZ-0514-48	copo óleo	8.10€



JAZ-051

Filtro lubrificador com regulador de pressão



Ref.	Entrada	Fluxo (l/min)	Pressão (bar)	Filtro (µm)	Preço
JAZ-0512	1/4"	1 000	0,5-8,5	5	85.20€
JAZ-0513	3/8"	1 350	0,5-8,5	5	92.50€
JAZ-0514	1/2"	3 000	0,5-8,5	5	124.80€
JAZ-0516	3/4"	3 100	0,5-8,5	5	131.00€

Nota: A pressão máxima de alimentação é de 8.5bar

JAZ-6704A

Filtro lubrificador com regulador de pressão

Entrada	Fluxo (l/min)	Pressão (bar)	Filtro (µm)	Preço
1/2"	1 250	1-10	5	120.70€



JAZ-6710A

Filtro de ar 1/2"

47.30€

JAZ-6711A

Regulador de pressão 1/2"

58.80€

JAZ-6712A

Lubrificador de ar 1/2"

48.20€

JAZ-6715A

Filtro de ar com regulador 1/2"

79.10€

JAZ-6704

Copo plástico para filtros lubrificadores JAZ-6704A/ JAZ-6710A

Ref.	Especif.	Preço
JAZ-6704-W	ar	11.60€
JAZ-6704-O	óleo	6.10€

JAZ-7214

Tubo espiral fêmea de 1/4"

Ref.	Medida (mm)	Compr. (m)	Preço
JAZ-7214F	5x8	13	30.50€
JAZ-7214S	6,5x10	13	38.20€
JAZ-7214Z	8x12	15	57.70€

GM-0

Tomada rápida fêmea

Ref.	Medida	Preço
GM-02AF	1/4"	7.20€
GM-03AF	3/8"	7.70€
GM-04AF	1/2"	8.00€

Acessórios para redes de ar comprimido
GM-0

Tomada rápida macho

Ref.	Medida	Preço
GM-02AM	1/4"	7.60€
GM-03AM	3/8"	7.20€
GM-04AM	1/2"	7.80€

GM-0

Tomada rápida tubo

Ref.	Medida	Preço
GM-02AH	1/4"	8.20€
GM-03AH	3/8"	8.20€
GM-04AH	1/2"	8.60€
GM-02BH	5/16"	8.40€

GM-0

Ponteira fêmea

Ref.	Medida	Preço
GM-02PF	1/4"	1.40€
GM-03PF	3/8"	2.60€
GM-04PF	1/2"	3.00€

GM-0

Ponteira macho

Ref.	Medida	Preço
GM-02PM	1/4"	1.30€
GM-03PM	3/8"	2.30€
GM-04PM	1/2"	2.80€

GM-0

Ponteira tubo

Ref.	Medida	Preço
GM-02PH	1/4"	1.60€
GM-03PH	3/8"	1.60€
GM-04PH	1/2"	1.90€
GM-02BPH	5/16"	1.60€

KIT AR

66.40€

Jogo de acessórios de ligação a rede de ar

Composição:

- GM-02AF Tomada rápida fêmea de 1/4"
- GM-02PF Ponteira fêmea de 1/4"
- GM-02PM Ponteira macho de 1/4"
- JAT-6905B Pistolete simples para ar
- JAZ-7214S Tubo espiral 13m





JONNESWAY®

Ferramentas Profissionais

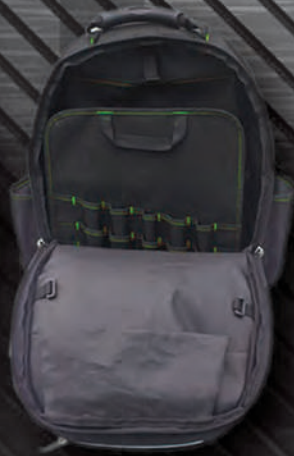



JONNESWAY[®]

Merchandising



Merchandising

BOUTJW01A-M 20.20€

BOUTJW01A-L 20.20€

BOUTJW01A-XL 20.20€

T-shirt

Com o logotipo da Jonnesway estampado no peito e na manga, nos tamanhos M, L e XL.



BOUTJW02A 10.90€

Boné

Com o logotipo da Jonnesway bordado.



JW-01B 21.10€

Boné

Com o logotipo da Jonnesway bordado.



BOUTJW03B 82.70€

Esferográfica 50 unidades

Com o logotipo da Jonnesway.



BOUTJW04A-M 63.20€

BOUTJW04A-L 63.20€

BOUTJW04A-XL 63.20€

Polar bege

Com o logotipo da Jonnesway bordado no peito, nos tamanhos M, L e XL.



BOUTJW05A 33.70€

Guarda-chuva 1 unidade

Com o logotipo da Jonnesway estampado.



BOUTJW06B 34.70€

Lona Jonnesway

Medidas: 1 480x890mm



BOUTJW07A-M 20.60€

BOUTJW07A-L 20.60€

BOUTJW07A-XL 20.60€

Polo

Com o logotipo da Jonnesway bordado no peito, nos tamanhos M, L e XL.



BOUTJW07B-M 30.10€

BOUTJW07B-L 30.10€

BOUTJW07B-XL 30.10€

Polo

Com o logotipo da Jonnesway bordado no peito, nos tamanhos M, L e XL.



BOUTJW08B-50 65.00€

BOUTJW08B-52 65.00€

BOUTJW08B-54 65.00€

Fato-macaco cinza

Com o logotipo da Jonnesway estampado no peito e nas costas.



JW-USB 19.60€

Dispositivo de armazenamento de dados - pen USB 1 unidade
Capacidade: 16 Gb



BOUTJW13A 16.50€

Para-sol

Com o logotipo da Jonnesway.



BOUTJW14B 28.80€

Mochila

Com o logotipo da Jonnesway bordado.

Dimensões: 280x380x120mm



JW-BACKPACK 130.00€

Mochila



BOUTJW15B 94.30€

Esferográfica "touch" 50 unidades
Com o logotipo da Jonnesway.



BOUTJW16A 3.80€

Porta chaves 1 unidade



JW-KEYRING02 2.00€ **Novo**

Porta chaves "Martelo" 1 unidade



JW-KEYRING03 2.00€ **Novo**

Porta chaves "Chave Inglesa" 1 unidade



BOUTJW17A-1 4.50€

Autocolante Jonnesway
Medidas: 70x400mm



BOUTJW17A-2 10.80€

Autocolante Jonnesway
Medidas: 100x600mm



BOUTJW18A 5.40€

Esferográfica
Com o logotipo da Jonnesway.



BOUTJW19A 60.40€

Esferográfica "roller ball"
Com o logotipo da Jonnesway.



BOUTJW20A-M 31.40€

BOUTJW20A-L 31.40€

BOUTJW20A-XL 31.40€

Sweat shirt

Com o logotipo da Jonnesway bordado no peito,
nos tamanhos M, L e XL.



BOUTJW21A-M 111.60€

BOUTJW21A-L 111.60€

BOUTJW21A-XL 111.60€

Colete

Com o logotipo da Jonnesway bordado no peito,
nos tamanhos M, L e XL.



BOUTJW22A-M 75.50€

BOUTJW22A-L 75.50€

BOUTJW22A-XL 75.50€

Casaco

Com o logotipo da Jonnesway bordado no peito,
nos tamanhos M, L e XL.



BOUTJW23A-M 67.80€

BOUTJW23A-L 67.80€

BOUTJW23A-XL 67.80€

Calças

Com o logotipo da Jonnesway bordado,
nos tamanhos M, L e XL.



BOUTJW24A 11.80€

Bloco de notas A5

Com o logotipo da Jonnesway.

Medidas: 140x210mm



BOUTJW25B 48.60€

Pasta A4

Com o logotipo da Jonnesway estampado.

Medidas: 245x325x40mm



BOUTJW26A

92.50€

Mala para portátil

Com o logotipo da Jonnesway estampado.

Medidas: 410x300x80mm



BOUTJW27A

28.90€

Rato sem fios

Com o logotipo da Jonnesway.



BOUTJW28A

35.80€

Base carregadora por indução para telemóveis

Dimensões: 69x10mm

Caraterísticas:

Carregador por indução com potência de carga até 10w.

Inclui cabo USB/ micro USB.

Compatível com smartphones com tecnologia de carregamento sem fios.



BOUTJW29A

215.00€

Bandeira barbatana tubarão

Dimensões: 660x2000mm



C-DSP

547.50€

Expositor para ferramenta com painéis perfurados e 30 ganchos

Medidas:

Altura: 2 140mm

Profundidade: 660mm

Largura: 940mm



C-DSP-0WB10

1.60€

Gancho para expositor C-DSP



DS96

133.70€

Expositor vazio para chaves de fenda

Capacidade: 96 chaves

Dimensões: 595x240x210mm



C-DS14

189.40€

Expositor para chaves caixa

Dimensões: 350x420x350mm



JAZ-ST4

49.00€

Base em acrílico para máquinas pneumáticas



FITA JW

6.00€

Fita Jonnesway para embalagem



JW-OPENER

5.00€

Tira cápsulas





JONNESWAY®

Ferramentas Profissionais





JONNESWAY®

Outros Equipamentos



Outros equipamentos

AE020009

472.50€

Bomba hidropneumática

Pressão de serviço: 690bar
 Alimentação: 7-10bar
 Dimensões: 257,50x127x204,50mm
 Peso: 8 000g
 Capacidade: 1 660cc



AE060002

850.50€

Macaco para transmissões

Altura máxima: 750mm
 Altura mínima: 200mm
 Capacidade: 1t
 Dimensões: 865x480mm
 Peso: 60kg



AE060003

1 636.80€

Macaco para transmissões

Altura máxima: 890mm
 Altura mínima: 165mm
 Capacidade: 1,5t
 Dimensões: 1 105x652mm
 Peso: 130kg



AE070002A

679.00€

Macaco de fossa

Altura máxima: 1 835mm
 Altura mínima: 1 035mm
 Capacidade: 600kg

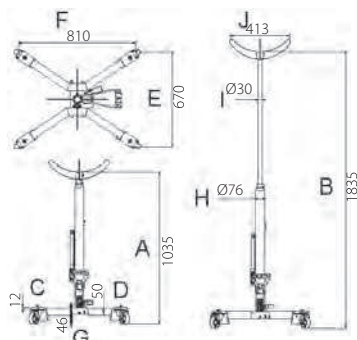

AE080001

943.30€

Macaco de fossa com prato universal

Altura máxima: 1 377mm
 Altura mínima: 880mm
 Capacidade: 500kg
 Prato: 729x597mm

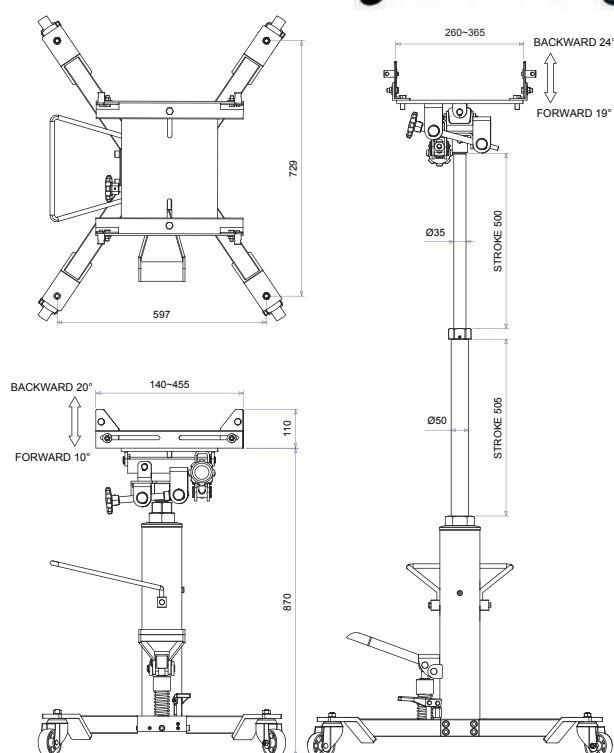

AG010236

72.40€

Suporte para movimentar pneus/ rodas



AG010154

16.70€

Banco plástico de apoio com rodas

Dimensões: 450x335x310mm

Peso: 1 500g



AG010222

101.50€

Banco metálico com rodas

Dimensões: 330x350x560mm

Capacidade: 130kg

Inclui:
Gaveta
Suportes laterais para peças



AE090105A

68.00€

Estrado para mecânico

Dimensões: 1 000x470x130mm

Carga admissível: 120kg



Novo

AE140015

496.70€

Suporte rotativo de motores para bancada

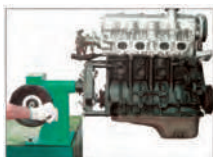

AE110020

1 157.20€

Macaco hidropneumático

Altura máxima: 377mm

Altura mínima: 205mm

Capacidade: 20t

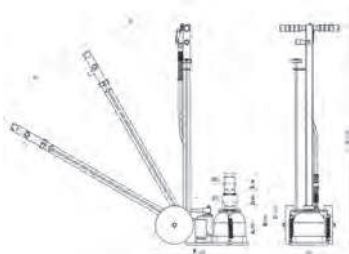

AE130003

1 267.50€

Grua hidráulica de 2t

Caraterísticas em mm:

Altura mínima: 60

Elevação máxima: 2 330

Largura da base: 718-936

Comprimento da base: 1 606-2 426

Comprimento máximo braço: 1 960



AE130003-1

175.00€

Travessa

Capacidade: 500kg



AE140013

1 034.90€

Suporte articulado de motores

Capacidade: 600kg



AE150001

302.90€

Preguiça

Altura: 710-1 065mm
Capacidade: 12t



AE150002

240.90€

Preguiça para pesados

Altura: 456-710mm
Capacidade: 12t



AE170002

183.90€

Travessa para suporte de motores

Ajuste: 530-1 480mm



AE010025A

407.90€

Jogo prensa de chapreiro de 4t

Composição:
Bomba hidráulica manual
Cilindro hidráulico: 4t (369-522mm)
Pinça de alargamento
Adaptadores
Extensões
Mala com rodas



AE010015A

658.50€

Jogo prensa de chapreiro de 10t

Composição:
Bomba hidráulica manual
Cilindro hidráulico: 10t (369-522mm)
Pinça de alargamento
Adaptadores
Extensões
Mala com rodas



AE050003

197.60€

Macaco chapreiro 5t

Capacidade: 5t
Comprimento: 750mm
Curso pistão: 160mm



AE180001

266.00€

Travessa para portas

Comprimento: 74-115mm



AE200003

1 455.00€

Elevador para rodas veículos pesados

Capacidade: 600kg
Elevação: 395mm



AE300149

164.60€

Aparadeira de óleo

Aparadeira regulável em altura em polietileno de alta densidade com descarga por gravidade.

Capacidade: 50l
 Peso: 12kg
 Dimensões: 550x550x990~1 070 mm



AR020016

105.10€

Multímetro digital e analisador automóvel

Funções: RPM, dwell, volts AC/DC, amps DC, resistências, ciclo de trabalho, temperatura, testes díodos e teste continuidade.



AR020060

250.70€

Pinça amperimétrica

De acordo com a norma IEC 1010 CAT III 1 000V

Multímetro digital com escalas automáticas
 Multifunções para AC/DV amp; AC/DC V e Ohms
 Capacitância, frequência e díodos
 Proteção de sobrecarga
 Memória
 RMS (valor eficaz)

Pinça amperimétrica: 2 000A - AC/DC
 Gama medição: 2 000 A AC/400A DC



AR020061

188.30€

Multímetro digital

De acordo com a norma IEC 1010 CAT III 1 000V

Mostrador de grande dimensão
 Escalas automáticas AC/DC para voltagem, amperagem, capacitância, frequência e resistência
 Leitura até 10 Amp com proteção e impedância alta para leituras de mV
 Memória
 RMS (valor eficaz)



AR030067

44.60€

Medidor de voltagem multifuncional

Pilhas não incluídas

Leitura de corrente AC/DC: 12-690V
 Mostrador LED/LCD



C-T4A

636.80€

Bancada de trabalho cinzenta com 3 gavetas

Tampo metálico com cobertura em acrílico

Medidas:
 Altura: 800mm
 Profundidade: 700mm
 Largura: 1 525mm



C-T5G-DP

131.50€

Painel traseiro cinzento para bancada

Aplicação:
 Bancada: C-T4A

Medidas:
 Altura: 700mm
 Largura: 1 525mm



C-DBU1

2.80€

Gancho para painel traseiro de bancada

Aplicação:
 Painel: C-T5G-DP
 Armários: C-SA
 Comprimento: 25,4mm



C-DBU7

3.00€

Gancho para painel perfurado

Aplicação:
 Painel: C-T5G-DP
 Armários: C-SA
 Comprimento: 50,8mm



AB	Pág.	AB030076-27	162	AE300179-02	142	AE320044	126
AB010001	160	AB030076-28	162	AE300179-03	142	AE330004	164
AB010002	160	AB030076-30	162	AE300180	142	AE330005	164
AB010002-A	160	AB030076-32	162	AE300201	127	AE330008	164
AB010017	160	AB030076-34	162	AE300202	127	AE330009	164
AB010018	160	AB030089	163	AE300204	127	AE330013	164
AB010019	160	AB030094J	162	AE300205	127	AE330015	164
AB010020	160	AB030100	163	AE300206	127	AE330016	164
AB010026S	160	AB030105	163	AE300207	127	AE330030	164
AB010041	161	AC	Pág.	AE300211	127	AE330034	164
AB010043	161	ACC-609	181	AE300212	123	AE330035	164
AB020002	161	AE0	Pág.	AE300215	128	AGO	Pág.
AB020003	161	AE010015A	200	AE300220	128	AG010002	88
AB020009	161	AE010025A	200	AE300221-02	142	AG010002S	88
AB020010	161	AE020009	198	AE300221-03	142	AG010002SP	26
AB020015	161	AE040020	122	AE300221-04	142	AG010003	88
AB020019	161	AE040038	122	AE310002	123	AG010005	88
AB030001	161	AE050003	200	AE310002-RK	123	AG010006	88
AB030014	161	AE060002	198	AE310003	164	AG010008	88
AB030028	161	AE060003	198	AE310004	164	AG010009	88
AB030041	161	AE070002A	198	AE310006	123	AG010011	89
AB030043	161	AE080001	198	AE310008	124	AG010012	89
AB030046	161	AE090105A	199	AE310010A	124	AG010023	114
AB030047	161	AE1	Pág.	AE310012	124	AG010024	163
AB030048	161	AE110020	199	AE310016	124	AG010024-1	163
AB030049	162	AE130003	199	AE310024	123	AG010024-2	163
AB030056	122	AE130003-1	199	AE310025	123	AG010026SP	26
AB030060	162	AE140013	199	AE310026	123	AG010030A	163
AB030061	122	AE140015	199	AE310027	123	AG010034	128
AB030068A	162	AE150001	200	AE310034	125	AG010035	128
AB030068C	162	AE150002	200	AE310035	125	AG010036	128
AB030068D	162	AE150005	122	AE310037	125	AG010046	128
AB030068F	162	AE170002	200	AE310038	125	AG010049	128
AB030069A	162	AE180001	200	AE310062	124	AG010055	163
AB030069B	162	AE2	Pág.	AE310063	124	AG010055-B	163
AB030069E	162	AE200003	200	AE310066	124	AG010059	128
AB030070B	162	AE3	Pág.	AE310073	124	AG010059-10	128
AB030070C	162	AE300064	122	AE310077	124	AG010059-12	128
AB030070D	162	AE300064-02	122	AE310087	124	AG010059-6	128
AB030071	163	AE300064-03	122	AE310099	124	AG010059-8	128
AB030076-00	162	AE300064-04	122	AE310109A	125	AG010089	128
AB030076-01	162	AE300064-05	122	AE310110	125	AG010099	129
AB030076-02	162	AE300064-06	122	AE310112	125	AG010109	129
AB030076-03	162	AE300064-07	122	AE310122	126	AG010111	128
AB030076-05	162	AE300064-15	122	AE310135	126	AG010118A	129
AB030076-06	162	AE300064-16	122	AE310146B	125	AG010138	164
AB030076-07	162	AE300100-040	122	AE310146D	125	AG010138-B	164
AB030076-11	162	AE300100-042	122	AE310146E	125	AG010140	165
AB030076-13	162	AE300100-060	122	AE310146G	125	AG010141	165
AB030076-14	162	AE300103	122	AE310146H	125	AG010142	165
AB030076-15	162	AE300149	201	AE310150	126	AG010143	165
AB030076-17	162	AE300152	123	AE310172	126	AG010147	129
AB030076-18	162	AE300154B	126	AE310172-1	126	AG010150SC	26
AB030076-20	162	AE300168	127	AE310180	126	AG010154	199
AB030076-21	162	AE300168-1	127	AE310183	126	AG010159	129
AB030076-24	162	AE300173	123	AE320023	126	AG010163A	128
AB030076-26	162	AE300176-A	123	AE320034	126	AG010164	128

AG010167	129	AI010116	153	AI030007	136	AI050202	141
AG010168	129	AI010121	150	AI030010	136	AI060006	142
AG010169	129	AI010127	133	AI030011	136	AI060020	142
AG010184B	77	AI010136	154	AI030020	136	AI060030	143
AG010184C	77	AI010137	133	AI030025	136	AI060030-A	143
AG010184D	77	AI010139	150	AI030027	137	AI060030-B	143
AG010184E	77	AI010153	165	AI030045	113	AI060030-C	143
AG010184F	76	AI010166	133	AI030067	140	AI060030-D	143
AG010185	163	AI010167	133	AI030075	146	AI060030-E	143
AG010204	153	AI010176	133	AI040005	137	AI060030-F	143
AG010205	147	AI010195	133	AI040006	137	AI060031	143
AG010207	129	AI010201	137	AI040007	137	AI060031-A	143
AG010208	130	AI020015	133	AI040008	137	AI060031-B	143
AG010222	199	AI020019	133	AI040011	137	AI060031-C	143
AG010224	129	AI020020	133	AI040017	137	AI060031-D	143
AG010225	129	AI020021	133	AI040018	137	AI060031-E	143
AG010227	130	AI020024	133	AI040031	137	AI060031-F	141
AG010229	130	AI020025	133	AI040038	141	AI060031-G	143
AG010236	199	AI020027	133	AI040060	137	AI060031-H	143
AG1	Pág.	AI020043	134	AI040064	138	AI060031-J	143
AG10001SP	26	AI020047	133	AI040245	165	AI1	Pág.
AG10001SP-D	130	AI020048A	134	AI040246	138	AI10001SP	26
AG10001SP-G	129	AI020048D	134	AI050001	140	AI10002SP	26
AG10001SP-T	130	AI020048E	134	AI050004	138	AI10003SP	27
AG10001SP-W	130	AI020049	134	AI050004A	139	ALO	Pág.
AG10002SC	38	AI020051	134	AI050008-10	140	AL010006	143
AG10002SC-W	130	AI020052	134	AI050009A	139	AL010011	143
AH0	Pág.	AI020054	134	AI050022	140	AL010029	156
AH020002	130	AI020056A	134	AI050024	140	AL010038	155
AIO	Pág.	AI020066	134	AI050037	140	AL010041	154
AI010006	130	AI020074	127	AI050040	140	AL010044	151
AI010009	130	AI020092	102	AI050042	140	AL010053A	156
AI010017	131	AI020101A	134	AI050043	140	AL010057	154
AI010023	131	AI020101A-A	134	AI050043S	136	AL010070	152
AI010029	131	AI020103	135	AI050071S	150	AL010071	152
AI010030	131	AI020107	135	AI050076	140	AL010072	156
AI010033	141	AI020109	135	AI050077	140	AL010073	144
AI010037	131	AI020113	153	AI050079	156	AL010081	156
AI010041	132	AI020127	155	AI050080	140	AL010087	156
AI010060	131	AI020131	135	AI050080	140	AL010088	156
AI010060-A	131	AI020142	135	AI050085A	153	AL010088	156
AI010060-B	132	AI020142	135	AI050092	141	AL010093	142
AI010060-C	132	AI020154	155	AI050093	141	AL010099	150
AI010060-D	132	AI020158	135	AI050096S	141	AL010113	165
AI010063A	132	AI020162	135	AI050102	141	AL010114	165
AI010069	155	AI020163	135	AI050104	141	AL010116	165
AI010070	155	AI020164	165	AI050109	141	AL010117	165
AI010086	132	AI020178	135	AI050113	141	AL010128	150
AI010090A	133	AI020180	135	AI050135	166	AL010175	152
AI010092	132	AI020184	136	AI050152	141	AL010190	155
AI010097	153	AI020184A	136	AI050152A	141	AL010196	151
AI010104	132	AI020184B	136	AI050172	166	AL010202	157
AI010107	152	AI020184S	136	AI050175	140	AL010203	157
AI010108	156	AI020185	136	AI050176	142	AL010205	152
AI010110	157	AI020186	153	AI050191	141	AL010218	152
AI010114	153	AI020201	136	AI050192	142	AL010225	157
AI010115	150	AI020205	136	AI050200	154	AL010282	153
		AI030002	138	AI050201	156	AL010291	157

ANO	Pág.				
AN010001	144	AN010320	147	AR060043	149
AN010001C	144	AN010321	144	AR060055	149
AN010001D	144	AN010322	144	AR060056	149
AN010001D-2	144	AN020007	147	AR060062	145
AN010001D-3	144	AN020007-1	147	AS	Pág.
AN010001D-4	144	AN020022	147	AS-0013	181
AN010001D-5	144	AN020022-A	147	AS-0013A2	181
AN010001D-6	144	AN020022-B	147	AS-0013C	181
AN010001D-7	144	AN020022-C	147	AS-0015	181
AN010001D-A	144	AN020022-D	147	AS-0015C	181
AN010001D-E	144	AN040035A	147	AS-0026	181
AN010001D-F	144	AN040043A	147	AS-0065	129
AN010001D-K	144	AN040055	166	BL	Pág.
AN010001D-M	144	AN040056	166	BLACK POWER 19	9
AN010001D-N	144	AN040062	166	BO	Pág.
AN010009A	140	AN040066	166	BOUTJW01A-L	192
AN010030	140	AN040082	103	BOUTJW01A-M	192
AN010033	145	AN040100	154	BOUTJW01A-XL	192
AN010038	145	AN040101	147	BOUTJW02A	192
AN010045	124	AN040105	166	BOUTJW03B	192
AN010049	145	AN040126	154	BOUTJW04A-L	192
AN010054A	145	AN040168	148	BOUTJW04A-M	192
AN010054N	145	AN040200	166	BOUTJW04A-XL	192
AN010063	145	AN040286	152	BOUTJW05A	192
AN010065	145	AN040327	146	BOUTJW06B	192
AN010066	145	AN1	Pág.	BOUTJW07A-L	192
AN010068	145	AN100002SP	27	BOUTJW07A-M	192
AN010072	145	ARO	Pág.	BOUTJW07A-XL	192
AN010072C	146	AR020016	201	BOUTJW07B-L	192
AN010081A	145	AR020018	148	BOUTJW07B-M	192
AN010085A	145	AR020019	148	BOUTJW07B-XL	192
AN010091A	146	AR020053A	148	BOUTJW08B-50	193
AN010092	146	AR020060	201	BOUTJW08B-52	193
AN010102	144	AR020061	201	BOUTJW08B-54	193
AN010106A	146	AR030005	99	BOUTJW13A	193
AN010106A-C	146	AR030013	148	BOUTJW14B	193
AN010112	146	AR030022	93	BOUTJW15B	193
AN010131	146	AR030034	148	BOUTJW16A	193
AN010137	146	AR030041	148	BOUTJW17A-1	193
AN010160	145	AR030047	148	BOUTJW17A-2	194
AN010177B	149	AR030058	93	BOUTJW18A	194
AN010186B	146	AR030062	148	BOUTJW19A	194
AN010187	165	AR030067	201	BOUTJW20A-L	194
AN010188A	146	AR040016	148	BOUTJW20A-M	194
AN010188B	146	AR040043	148	BOUTJW20A-XL	194
AN010188C	146	AR060002A	148	BOUTJW21A-L	194
AN010202	156	AR060003	149	BOUTJW21A-M	194
AN010202B	156	AR060008	149	BOUTJW21A-XL	194
AN010225	146	AR060009	149	BOUTJW22A-L	194
AN010226	147	AR060010	149	BOUTJW22A-M	194
AN010235	166	AR060020	149	BOUTJW22A-XL	194
AN010237	166	AR060021	149	BOUTJW23A-L	194
AN010272	147	AR060024A	149	BOUTJW23A-M	194
AN010279	147	AR060029A	149	BOUTJW23A-XL	194
AN010293	144	AR060032	149	BOUTJW24A	194
AN010319	147	AR060038	149	BOUTJW25B	194
		AR060039A	149	BOUTJW26A	195
				BOUTJW27A	195
				BOUTJW28A	195
				BOUTJW29A	195
				C-1	Pág.
				C-10DW42	20
				C-13DW53	20
				C-1DM1	19
				C-3	Pág.
				C-3DH1	21
				C-3DH2	21
				C-3DH262	21
				C-3DH262V	21
				C-3DH5	22
				C-3DH6	22
				C-3DW5	19
				C-4	Pág.
				C-4DWA1	19
				C-4DWA1G	19
				C-5	Pág.
				C-5CD	22
				C-6	Pág.
				C-6DA4	22
				C-6DA494	22
				C-6DWB1	19
				C-6DWB1G	19
				C-6DWB5	19
				C-7	Pág.
				C-7 TOWER	20
				C-7DC2B	19
				C-7DS1	19
				C-7DW1-TS	23
				C-7DW9	20
				C-A	Pág.
				C-A10	24
				C-A11	24
				C-A12	24
				C-A13	24
				C-A16W	20
				C-A17W	20
				C-A17WG	20
				C-A2501S	24
				C-A27	23
				C-A3	23
				C-A3-B	23
				C-A31	23
				C-A3G	23
				C-A456	23
				C-A7	24
				C-A8	24
				C-A9	23
				C-APB	24
				C-B	Pág.
				C-B5	24
				C-BS Kit1	23
				C-BS Kit2	23
				C-BS Kit3	23
				C-D	Pág.
				C-DBU1	201
				C-DBU7	201

C-DM1	129	D10M30M10A	105	D130T30	104	D3750S16	101
C-DMH212	74	D10M30M12A	105	D130T40	104	D3750S20	101
C-DMH314	74	D10M30M14A	105	D130T45	104	D3750S24	101
C-DMH414	74	D10M75M05A	105	D130T50	104	D3750S30	101
C-DS14	195	D10M75M06A	105	D130T55	104	D3750T08S	100
C-DSP	195	D10M75M08A	105	D15	Pág.	D3750T10	101
C-DSP-0WB10	195	D10M75M10A	105	D150F5510A	104	D3750T15	101
C-P	Pág.	D10M75M12A	105	D150F6512A	104	D3750T18S	101
C-PC1	23	D10M75M14A	105	D150F8012A	104	D3750T20	101
C-PC2	23	D100N	Pág.	D150H030A	105	D3750T5	101
C-PC3	23	D100N13M	105	D150H040A	105	D3750T6	101
C-PC4	23	D12	Pág.	D150H050A	105	D3750T7	101
C-T	Pág.	D125F4506A	104	D150H060B	105	D3750T8	101
C-T12	22	D125F6512A	104	D150H070B	105	D3750T9	101
C-T3	21	D125F8016A	104	D150H080B	105	D376514SC	38
C-T4A	201	D125H015A	104	D150MH1AD	106	D70	Pág.
C-T5G-DP	201	D125H020A	104	D150MH1QD	106	D70105KV	34
C-W	Pág.	D125H025A	104	D150P1A	104	D70105SP	27
C-WHEEL1	24	D125H030A	104	D150P2A	104	D70P175	96
C-WHEEL2	24	D125H040A	104	D150P3A	104	D70P2100	96
C-WHEEL5	24	D125H050A	104	D150T20A	105	D70P3125	96
C-WHEEL6	24	D125H060A	104	D150T25A	105	D70P3150	96
C-WHEEL8	24	D125H070A	104	D150T27A	105	D70PP07S	99
C-WHEEL9	24	D125P1F	104	D150T30A	105	D70PP10S	99
CF	Pág.	D125P2F	104	D150T40A	105	D70PS119KV	34
CF-K-C	183	D125P3F	104	D150Z1A	104	D70S475	96
CF-K-E	183	D125T06B	104	D150Z2A	104	D70S5100	96
CF-K-E	183	D125T08B	104	D150Z3A	104	D70S6125	96
CF-K-F	183	D125T10A	104	D16	Pág.	D70S6150	96
CF-K-G	183	D125T15A	104	D160MH1QD	106	D70S8150	96
CF-K-I	183	D125T20A	104	D165MN06M	106	D70S8175	96
CF-K-J	183	D125T25A	104	D165MN07M	106	D70S9175	96
CH	Pág.	D125T27A	104	D165MN08M	106	D70S9250	96
CHAPEIRO20- BLACK	15	D125T30A	104	D165MN10M	106	D71	Pág.
CHAPEIRO20-C	15	D125T40A	104	D165MN12M	106	D71157SV	32
CHAPEIRO20-V	15	D125TT08A	105	D165MN13M	106	D71400T10	99
CHAPEIROALU-BLACK	16	D125TT10A	105	D17	Pág.	D71400T15	99
CHAPEIROALU-C	16	D125TT15A	105	D175H100	105	D71400T20	99
CHAPEIROALU-V	16	D125TT20A	105	D175H120	105	D71400T25	99
D04P	Pág.	D125TT25A	105	D175H40	105	D71400T27	99
D04P180	98	D125TT27A	105	D175H50	105	D71400T30	99
D04P2100	98	D125TT30A	105	D175H60	105	D715N05	98
D04P3150	98	D125TT35A	105	D175H70	105	D715N07	98
D04S	Pág.	D125TT40A	105	D175H80	105	D715N08	98
D04S480	98	D125Z1A	104	D175T20	105	D715N10	98
D04S5125	98	D125Z2A	104	D175T25	105	D715N12	98
D04S6100	98	D125Z3A	104	D175T30	105	D715N13	98
D04S6150	98	D13	Pág.	D175T40	105	D71C105S	99
D10	Pág.	D130H100	104	D175T45	105	D71C106S	99
D100MN08M	105	D130H120	104	D175T50	105	D71P060	97
D100MN10M	105	D130H40	104	D175T55	105	D71P1100	97
D100MN12M	105	D130H50	104	D37	Pág.	D71P1150	97
D100MN13M	105	D130H60	104	D3750P0	101	D71P1300	97
D100MN14M	105	D130H70	104	D3750P00	101	D71P138	97
D10M30M05A	105	D130H80	104	D3750P08S	100	D71P180	97
D10M30M06A	105	D130T20	104	D3750P1	101	D71P2100	97
D10M30M08A	105	D130T25	104	D3750S10	101	D71P2150	97

D71P2250	97	D72	Pág.	EV	Pág.	H01SA150	107
D71P238	97	D725N06	99	EVA POWER BLACK	7	H01SA160	107
D71P2400	97	D725N07	99	EVA POWER-C	7	H01SA180	107
D71P3150	97	D725N08	99	EVA POWER-V	7	H01SM109S	106
D71P3250	97	D725N08SP	27	F	Pág.	H02	Pág.
D71P3400	97	D725N09	99	FITA JW	195	H02MH217S	106
D71P4200	97	D725N10	99	GM	Pág.	H02SM109S	106
D71PP08KV	35	D725N11	99	GM-02AF	189	H02SM209S	106
D71PP08S	99	D725N12	99	GM-02AH	189	H03	Pág.
D71PP08SP	27	D725N13	99	GM-02AM	189	H03MH118S	108
D71PP16S	100	D73	Pág.	GM-02BH	189	H03SM109S	108
D71S10250	97	D737128SV	32	GM-02BPH	189	H03SS109S	108
D71S250	97	D737134SV	32	GM-02PF	189	H05	Pág.
D71S360	97	DBT	Pág.	GM-02PH	189	H05SA109S	108
D71S4100	97	DBT31B	101	GM-02PM	189	H05SS109S	108
D71S4150	97	DBT53A	102	GM-03AF	189	H06	Pág.
D71S4200	97	DR0	Pág.	GM-03AH	189	H06SA109S	108
D71S480	97	DR0107S	101	GM-03AM	189	H06SA1100	107
D71S5125	97	DR0119S	101	GM-03PF	189	H06SA115	107
D71S5200	97	DR0253S	101	GM-03PH	189	H06SA120	107
D71S5300	97	DR04	101	GM-03PM	189	H06SA125	107
D71S538	97	DS9	Pág.	GM-04AF	189	H06SA130	107
D71S575	97	DS96	195	GM-04AH	189	H06SA140	107
D71S6100	97	DV1	Pág.	GM-04AM	189	H06SA150	107
D71S6150	97	DV13P060	116	GM-04PF	189	H06SA160	107
D71S638	97	DV13P180	116	GM-04PH	189	H06SA180	107
D71S6400	97	DV13P2100	116	GM-04PM	189	H06SM209S	108
D71S8150	97	DV13P3150	116	H01	Pág.	H06SM2100	108
D71S8200	97	DV13PP07S	117	H01B1015	106	H06SM225	108
D71S8300	97	DV13S275	116	H01B1020	106	H06SM230	108
D71S8300	97	DV13S3100	116	H01B1025	106	H06SM240	108
D71S8500	97	DV13S4100	116	H01B1030	106	H06SM250	108
D71S9175	97	DV13S5125	116	H01B1035	106	H06SM255	108
D71T10	98	DV13S6150	116	H01B1040	106	H06SM260	108
D71T107S	100	DV13S8175	116	H01B1045	106	H06SM280	108
D71T109S	100	DV13Z060	116	H01B1050	106	H06ST108S	108
D71T15	98	DV13Z180	116	H01B1055	106	H06W106S	108
D71T20	98	DV13Z2100	116	H01B1060	106	H07	Pág.
D71T25	98	DV13Z3150	116	H01B1070	106	H07M09S	108
D71T27	98	DV15109S	117	H01B1080	106	H07MT10	108
D71T30	98	DV15PP-TP	99	H01B1090	106	H07MT15	108
D71T40	98	DV4	Pág.	H01B1100	106	H07MT20	108
D71T45	98	DV4118SV	117	H01B1120	106	H07MT25	108
D71T5	98	DV41M06S	117	H01B1140	106	H07MT27	108
D71T50	98	DV41M10	117	H01B1160	106	H07MT30	108
D71T6	98	DV41M13	117	H01B1170	106	H07MT40	108
D71T7	98	DV41M5	117	H01B1180	106	H07MT45	108
D71T8	98	DV41M6	117	H01B1190	106	H07MT50	108
D71T9	98	DV41M7	117	H01B1220	106	H08	Pág.
D71Z060	98	DV41M8	117	H01MH118S	106	H0816S	109
D71Z105S	100	EL	Pág.	H01SA109S	106	H08MTP09S	109
D71Z107S	100	ELECTR-BLACK	14	H01SA1100	107	H08S110S	109
D71Z138	98	ELECTR-C	14	H01SA115	107	H08ST0908S	109
D71Z180	98	ELECTR-V	14	H01SA120	107	H08ST10090	109
D71Z2100	98	ELECTR. 1000 BLACK	12	H01SA125	107	H08ST15100	109
D71Z3150	98	ELECTR. 1000-C	12	H01SA130	107	H08ST20115	109
D71Z4200	98	ELECTR. 1000-V	12	H01SA140	107	H08ST25130	109

H08ST27145	109	H22	Pág.	JA-HVLP-1080GK	180	JAH-0288-17	185
H08ST30165	109	H22S109S	110	JA-HVLP-3000-NS17	180	JAH-0288-RK	185
H08ST40185	109	HC	Pág.	JA-HVLP-3000-NS19	180	JAH-308HK	185
H08ST45205	109	HC-100/15	139	JA-HVLP-300C (1.3)	180	JAH-308H-RK	185
H08ST50230	109	HC-106/15	139	JA-HVLP-6112	180	JAH-6837	185
H10	Pág.	HC-108/15	139	JA-LVLP-0303W	180	JAH-6837-50	185
H10121SV	32	HC-108/18	139	JA-LVLP-0303W-N	180	JAH-6837-50-2	185
H10MB08KV	35	HC-65/14	139	JA-LVLP-0303W-N18	180	JAH-6837-RK	185
H10MB08S	109	HC-65/67	139	JAB	Pág.	JAH-7104H	185
H10MB08SP	27	HC-65103	139	JAB-1017	174	JAH-7104H-RK	185
H10MB10200	109	HC-66/6	139	JAB-1017-RK	174	JAI	Pág.
H10MB2100	109	HC-68/14	139	JAB-1018	174	JAI-0501-RK	172
H10MB25100	109	HC-73/14	139	JAB-1018-RK	174	JAI-0926-RK	170
H10MB3100	109	HC-74/15	139	JAB-7003A	175	JAI-0936	170
H10MB4100	109	HC-74/76	139	JAB-7003A-RK	175	JAI-0936-RK	170
H10MB5150	109	HC-75/77	139	JAD	Pág.	JAI-0938	171
H10MB6150	109	HC-76/12	139	JAD-0212	173	JAI-0938-RK	171
H10MB8200	109	HC-76/14	139	JAD-0212-RK	173	JAI-0954	169
H10MT08KV	35	HC-76/30	139	JAD-0413	173	JAI-0954-RK	169
H10MT08SP	27	HC-76/8	139	JAD-0413-RK	173	JAI-1024	168
H10MT09S	109	HC-78/15	139	JAD-0534	173	JAI-1024-RK	168
H10MT10100	109	HC-80/15	139	JAD-0534-RK	173	JAI-1054	169
H10MT15100	109	HC-80/82	139	JAD-1015-RK	175	JAI-1054-RK	169
H10MT20100	109	HC-86/16	139	JAD-1015K	175	JAI-1114	168
H10MT25100	109	HC-86/18	139	JAD-1020	174	JAI-1114-RK	168
H10MT27150	109	HC-9.5mm	139	JAD-1020-RK	174	JAI-1114K	168
H10MT30150	109	HC-90/15	139	JAD-1021	174	JAI-1124	168
H10MT40150	109	HC-92/10	139	JAD-1021-RK	174	JAI-1124-RK	168
H10MT45200	109	HC-93/15	139	JAD-1027	174	JAI-1138	171
H10MT50200	109	HC-93/36	139	JAD-1027-RK	174	JAI-1138-RK	171
H12	Pág.	HC-93/45	139	JAD-6252A	174	JAI-1138L	171
H12S09085	107	HC-95/15	139	JAD-6252A-RK	174	JAI-1206L	170
H12S10090	107	HC-96/18	139	JAG	Pág.	JAI-1206L-RK	171
H12S110S	109	HV	Pág.	JAG-0903-MS	175	JAI-1232-RK	169
H12S15100	107	HV1000V-BLACK	13	JAG-0906R/RM-RK	175	JAI-1232K	169
H12S20115	107	HV1000V-C	13	JAG-0906RMK	175	JAI-1408	171
H12S25130	107	HV1000V-V	13	JAG-0913RM-RK	175	JAI-1408-RK	171
H12S27145	107	JA	Pág.	JAG-0913RMK	175	JAI-1408L	171
H12S30165	107	JA-0001RK	181	JAG-0923RM	176	JAI-1513	169
H12S40185	107	JA-300C-28	181	JAG-0923RM-RK	176	JAI-1513-RK	169
H12S45205	107	JA-300C-NS13	180	JAG-0925RM	176	JAI-1514	170
H12S50230	107	JA-3806C	181	JAG-0925RM-RK	176	JAI-1514-RK	170
H15	Pág.	JA-3808A	181	JAG-0955RM	176	JAI-1524	168
H15M105S	110	JA-3812A	186	JAG-0955RM-RK	176	JAI-1524-RK	169
H20	Pág.	JA-3812D	186	JAG-1087	176	JAI-6202-RK	172
H20MB1037S	110	JA-5032	186	JAG-1087-RK	176	JAI-6211	170
H20MT08SP	27	JA-6111-NS13	180	JAG-6638	176	JAI-6211-RK	170
H20MT09S	110	JA-6111-NS17	180	JAG-6638-DC	176	JAI-6212-RK1	170
H20MT10	107	JA-6111-NS20	180	JAG-6638-DR	176	JAI-6212K	170
H20MT15	107	JA-6111(1.4)	180	JAG-6638-RK	176	JAR	Pág.
H20MT20	107	JA-6111K	180	JAG-6639	176	JAR-1012	172
H20MT25	107	JA-7253	187	JAG-6639-DC	177	JAR-1012-RK	172
H20MT27	107	JA-7254	187	JAG-6639-DR	177	JAR-1013	172
H20MT30	107	JA-950	181	JAG-6639-RK	177	JAR-1013-RK	172
H20MT40	107	JA-950-04	181	JAH	Pág.	JAR-1033	173
H20MT45	107	JA-960	181	JAH-0288	185	JAR-1033-RK	173
H20MT50	107	JA-C131SV	32	JAH-0288-15	185	JAR-1094	172
		JA-HVLP-1080GD-N1.4	180	JAH-0288-16	185		

JAR-1094-RK	172	JAT-1041-16S	182	JAT-6952P-RK	184	M06	Pág.
JAR-6309A-RK	172	JAT-10T18	183	JAT-6959	187	M06030	111
JAR-6309AK	172	JAT-10T32	183	JAT-6959A	187	M06040	111
JAR-6310A	172	JAT-12F1	182	JAZ	Pág.	M07	Pág.
JAR-6310A-RK	173	JAT-12F2	182	JAZ-0001B	187	M07016	111
JAR-6310AK	173	JAT-12F3	182	JAZ-0002A	187	M07016-ACE	111
JAS	Pág.	JAT-12F4	182	JAZ-0002B	187	M07016-TPR	111
JAS-0010	177	JAT-20T14	182	JAZ-0002C	187	M09	Pág.
JAS-0010-41	177	JAT-20T18	182	JAZ-0042	187	M09100	111
JAS-0010-RK	177	JAT-20T24	182	JAZ-011H	185	M091000	111
JAS-0413	177	JAT-460	186	JAZ-016H	185	M09103KV	35
JAS-0413-RK	177	JAT-480-NS	186	JAZ-0512	188	M09200	111
JAS-0423-31	178	JAT-481	186	JAZ-0513	188	M09300	111
JAS-0423-RK	178	JAT-501	186	JAZ-0513-09	187	M09500	111
JAS-0423K	178	JAT-6004K	186	JAZ-0513-50	187	M09513SP	28
JAS-0452	181	JAT-6034	185	JAZ-0514	188	M09800	111
JAS-0452-RK	182	JAT-6034-1A	185	JAZ-0514-06	187	M10	Pág.
JAS-1021-6HE-RK	178	JAT-6034-1B	185	JAZ-0514-09	187	M10110	163
JAS-1021-6HE(2.5)	178	JAT-6034-1C	185	JAZ-0514-13	187	M10210A	163
JAS-1031-6HE	179	JAT-6034-1D	185	JAZ-0514-48	187	M10210B	163
JAS-1031-6HE-RK	179	JAT-6034-RK	185	JAZ-0516	188	M10410A	163
JAS-1031-6HP	179	JAT-6412	184	JAZ-3811E	186	M10410B	163
JAS-1031-6HP	179	JAT-6412-RK	184	JAZ-39520	187	M11	Pág.
JAS-1206-6HE	178	JAT-6421	183	JAZ-6704-O	189	M11035	111
JAS-1206-6HE-RK	178	JAT-6421-33	183	JAZ-6704-W	189	M11045	111
JAS-1206-6HP	178	JAT-6421-RK	183	JAZ-6704A	188	M11065	111
JAS-1207-6HE	178	JAT-6441-RK	183	JAZ-6710A	189	M29	Pág.
JAS-1207-6HE-56	178	JAT-6441K	183	JAZ-6711A	189	M2927-T1	111
JAS-1207-6HE-57	179	JAT-6443-K1	184	JAZ-6712A	189	M2927-T2	111
JAS-1207-6HE-RK	178	JAT-6443-K2	184	JAZ-6715A	189	M2932	111
JAS-6505	177	JAT-6443-K3	184	JAZ-7207	175	M2932-T1	111
JAS-6505-RK	177	JAT-6443-K4	184	JAZ-7214F	189	M2932-T2	111
JAS-6531	179	JAT-6443-K5	184	JAZ-7214S	189	M2940-T2	111
JAS-6531-LIXA	179	JAT-6443-K6	184	JAZ-7214Z	189	M2950-T1	111
JAS-6531-RK	179	JAT-6443-K7	184	JAZ-ST4	195	M2950-T2	111
JAS-6535-5HE	179	JAT-6443-RK	184	JW	Pág.	M60	Pág.
JAS-6535-5HE-47	179	JAT-6443K	184	JW-01B	192	M60103	112
JAS-6535-5HE-RK	179	JAT-6613	183	JW-BACKPACK	193	M60104	112
JAS-6535-5VE-RK	179	JAT-6613-P	183	JW-KEYRING02	193	M60105	112
JAS-6535-6HE	179	JAT-6613-PA	183	JW-KEYRING03	193	M61	Pág.
JAS-6535-6HE-RK	179	JAT-6613-RK	183	JW-OPENER	195	M61110	112
JAS-6542	182	JAT-6673	186	JW-USB	193	M61112	112
JAS-6542-RK	182	JAT-6673-RK	186	K	Pág.	M61113	112
JAS-6543	182	JAT-6676	183	KIT AR	189	M61116	112
JAS-6543-RK	182	JAT-6676-RK	183	M01	Pág.	M61119	112
JAS-6543-RK	182	JAT-6904S	187	M01016	111	M61122	112
JAS-6551	177	JAT-6905-C	187	M01020	111	M61125	112
JAS-6551-RK	177	JAT-6905-J	187	M03	Pág.	M61H116	113
JAS-6552	177	JAT-6905B	187	M03025	111	M61H119	113
JAS-6552-RK	177	JAT-6905S	187	M04	Pág.	M61H124	113
JAT	Pág.	JAT-6943A	184	M04008	111	M62	Pág.
JAT-1011	182	JAT-6943A-RK	184	M04012	111	M62102	112
JAT-1011-RK	182	JAT-6952	184	M04016	111	M62103	112
JAT-1020-RK	182	JAT-6952-RK	184	M04024	111	M62104	112
JAT-1020K	182	JAT-6952P	184	M04032	111	M62105	112
JAT-1035	186	JAT-6952P-37	184	M05	Pág.	M62106	112
JAT-1035-RK	186	JAT-6952P-39	184	M05020	111	M62108	112
JAT-1041	182	JAT-6952P-40	184				

M62H102	113	MG0	Pág.	MT010006	160	P-TR (PC303ST)	41
M62H103	113	MG010001	158	MT010007	160	P-TR (S04H4120ST)	41
M62H104	113	MG010002	158	MT010008	160	P-TR (S04H4506ST)	41
M62H106	113	MG010003	158	MT0901	114	P-TR (W26107ST)	41
M63	Pág.	MG010004	158	MT0902	114	P-TR (W26920ST)	41
M63102	112	MG010005	158	MTC	Pág.	P-TR(AG010002SP)	41
M63103	112	MG010006	158	MTC101SP	28	P-TR(AG010026SP)	41
M63104	112	MG010008	158	MTC1150	115	P-TR(AI10002SP)	41
M63105	112	MG010009	158	MTC1200	115	P-TR(D70105SP)	41
M63106	112	MG020001	158	MTC1300	115	P-TR(D71PP08SP)	41
M63106S	113	MG020003	158	MTC150	115	P-TR(H10MB08SP)	41
M63108	112	MG020004	158	MTC153	115	P-TR(M09513SP)	41
M63113KV	35	MG020006	158	MTC155	115	P-TR(M645114SP)	41
M63H103	113	MG020007	158	MTC156	115	P-TR(P018SP)	41
M63H105	113	MG020008	159	MTC200	115	P-TR(P04704SP)	41
M63H106	113	MHS	Pág.	MTC306	115	P-TR(P0803SP)	41
M63H108	113	MHS08KV	35	MTC308	115	P-TR(P0903SP)	41
M63M106S	113	MHS100AG	114	MTC408	115	P-TR(P2710SP)	41
M64	Pág.	MHS300	114	MTC508	115	P-TR(S03A4122SP)	41
M64105	112	MI1	Pág.	MTM	Pág.	P-TR(S04H2125SP)	41
M64105S	113	MI010014	159	MTM1025	115	P-TR(S04H3157SP)	41
M645114SP	28	MI010016	159	MTM1050	115	P-TR(S04H3536SP)	41
M64A155	113	MI010017	159	MTM1075	115	P-TR(S04H4125SP)	41
M64M105S	113	MI010018	159	MTM1100	115	P-TR(S04H4524SP)	41
ME0	Pág.	MI010019	159	P-B	Pág.	P-TR(S04H4726SP)	41
ME010001	157	MI010020	159	P-B (31)	41	P-TR(S04H4728SP)	41
ME010007	157	MI010021	159	P-B (41)	41	P-TR(S06H427SP)	41
ME010009	157	MI020001	159	P-E	Pág.	P-TR(S09H4118SP)	41
ME010010	157	MI020002	159	P-EVA(D70105KV)	39	P-TR(S29H4140SP)	41
ME010012	157	MI020004	159	P-EVA(D71PP08KV)	39	P-TR(W23108SP)	41
ME020001	158	MK2	Pág.	P-EVA(D737128SV)	39	P-TR(W25110SP)	41
ME020002	158	MK2040	114	P-EVA(D737134SV)	39	P-TR(W26112SP)	41
ME020003	158	MK2040-B	114	P-EVA(H10121SV)	39	P-TR(W26116SP)	41
ME020005	158	MK2080	114	P-EVA(H10MB08KV)	39	P01	Pág.
ME020006	158	MKS	Pág.	P-EVA(H10MT08KV)	39	P0118	90
MEC	Pág.	MKS27	114	P-EVA(M09103KV)	39	P011804KV	35
MEC PESADOS 20A	18	MKS27-12	114	P-EVA(M63113KV)	39	P018	88
MEC PESADOS 20B	18	MKS27-16	114	P-EVA(MHS08KV)	39	P018SP	28
MEC POLEGADAS	10	MKS27-16A	114	P-EVA(P011804KV)	39	P018SP1	28
MEC POWER 19C	9	MKS27-20	114	P-EVA(P32M105KV)	39	P03	Pág.
MEC POWER 19V	9	MKV	Pág.	P-EVA(P82714SV)	39	P038	88
MEC PROF20-BLACK	11	MKV7	117	P-EVA(P82736SV)	39	P04	Pág.
MEC PROF20-C	11	MKV7-K	117	P-EVA(S03A4122KV)	40	P046	88
MEC PROF20-V	11	MKV8	117	P-EVA(S04H2132KV)	40	P04704SP	28
MEC SOLUTION BLACK	8	MNO	Pág.	P-EVA(S04H4144KV)	40	P05	Pág.
MEC SOLUTION-C	8	MNO20004	159	P-EVA(S04H42165SV)	40	P0516	90
MEC SOLUTION-V	8	MNO20005	159	P-EVA(S04H4295SV)	40	P0518	90
MF0	Pág.	MSH	Pág.	P-EVA(S04H45121SV)	40	P06	Pág.
MF05A	114	MSH1214	74	P-EVA(S07H2138KV)	40	P068	88
MF05B	114	MSH1414	74	P-EVA(S29H4141KV)	40	P068A	88
MF05C	114	MSH3814	74	P-EVA(W23559SV)	40	P07	Pág.
MF05D	114	MT0	Pág.	P-EVA(W25110KV)	40	P079	88
MF05E	114	MT010001	159	P-EVA(W26116KV)	40	P08	Pág.
MF05S	114	MT010002	159	P-EVA(W26134SV)	40	P0803SP	28
MFM	Pág.	MT010003	160	P-EVA(W2623431SV)	40	P08104S	91
MF06S	114	MT010004	160	P-T	Pág.	P0813SC	38
		MT010005	160	P-TR (D70SP06ST)	41	P0816	90

P0817	90	P32M10C	94	P7802	95	R12	Pág.
P0818	90	P36	Pág.	P7803	95	R1206N	43
P09	Pág.	P36M01P	93	P7804	95	R1206N-R	45
P0903SP	28	P36M02P	93	P7805	95	R1206R	45
P0916	90	P36M06C	95	P78M10C	95	R12081	43
P0917	90	P36M09A	93	P80	Pág.	R12081RK	45
P0918	90	P36M09C	95	P8006	89	R19	Pág.
P10	Pág.	P37	Pág.	P81	Pág.	R19H310S	78
P1016	90	P37M11A	94	P8106	89	R19H3110	78
P1017	90	P37M18A	94	P82	Pág.	R19H3111	78
P1019	94	P38	Pág.	P82714SV	32	R19H3112	78
P11	Pág.	P38M09A	94	P82736SV	33	R19H3113	78
P1116	90	P38M11A	94	P86	Pág.	R19H3114	78
P1118	90	P40	Pág.	P8606	89	R19H3115	78
P12	Pág.	P4016	90	P90	Pág.	R19H3116	78
P1216	90	P43	Pág.	P9006	89	R19H3117	78
P1218	90	P4318	91	P94	Pág.	R19H3118	78
P14	Pág.	P4318-RK	91	P9409	94	R19H3119	78
P1416	90	P4330	91	P95	Pág.	R29	Pág.
P15	Pág.	P4330-RK	91	P9506	88	R2902	44
P1516	90	P52	Pág.	P9508C	89	R2902RK	45
P15808	91	P52A10	94	P9508D	89	R2903RK	45
P17	Pág.	P52B10	94	P9512	88	R2904	44
P178	91	P52C10	94	P96	Pág.	R2904RK	45
P18	Pág.	P52D12	94	P9601	114	R34	Pág.
P1810	91	P52M10	94	P99	Pág.	R3402RK	45
P20	Pág.	P52N10	94	P9902S	89	R3403	44
P2010LA	91	P53	Pág.	P9920-BT	89	R3403RK	45
P2010RA	91	P53M06	94	P9920-ST	89	R3404RK	45
P2010SA	91	P53M11	94	PES	Pág.	R35	Pág.
P22	Pág.	P53M18	94	PESD05	91	R3502	44
P2205E	91	P54	Pág.	PESD10	91	R3503	44
P2208A	91	P54M08A	94	PESD11	91	R3504	44
P2212A	91	P54M10A	94	PIN	Pág.	R36	Pág.
P26	Pág.	P60	Pág.	PINTOR20-BLACK	17	R3602	44
P266	88	P6008	88	PINTOR20-C	17	R3602RK	45
P27	Pág.	P61	Pág.	PINTOR20-V	17	R3603	44
P2706	88	P6106	88	PSV	Pág.	R3603RK	45
P2710	88	P6108	88	PSV110SC	118	R3604RK	45
P2710SP	28	P6118	90	PSV218SP	118	R37	Pág.
P2712	88	P64	Pág.	PV0	Pág.	R3702	44
P28	Pág.	P6424	92	PV0118	117	R3702B	44
P2803SP	29	P71	Pág.	PV0518	118	R3703	44
P2810	88	P7101	89	PV0816	117	R3704	44
P28110	90	P7102	89	PV0817	117	R3704B	44
P28112	90	P7103	89	PV0918	118	R41	Pág.
P28210	90	P7104	89	PV1	Pág.	R4103	44
P28212	90	P7105	89	PV1016	118	R4104	44
P30	Pág.	P76	Pág.	PV1116	118	R45	Pág.
P30M07C	94	P7601	92	PV1118	118	R4602	44
P30M10A	93	P7602	92	PV1218	118	R4603	44
P32	Pág.	P7603	92	PV1416	118	R4604	44
P32M03S	95	P7608	92	PV1516	118	R46	Pág.
P32M05C	94	P77	Pág.	PV2	Pág.	R4502	44
P32M07A	93	P7719	92	PV28110	118	R48	Pág.
P32M105KV	36	P78	Pág.	PV4	Pág.	R4802	44
P32M10A	93	P7801	95	PV4006	118	R4802A	44

R4802B	44	S03A2UT	79	S03A6148	81	S03AD	Pág.
R4802RK	45	S03A3UT	79	S03A6149	81	S03AD4110	80
R4803	44	S03A4UT	79	S03A6150	81	S03AD4111	80
R4804	44	S03A4109	80	S03A6151	81	S03AD4111S	78
R4804A	44	S03A4110	80	S03A6152	81	S03AD4112	80
R4804B	44	S03A4111	80	S03A6153	81	S03AD4113	80
R4804RK	45	S03A4111S	78	S03A6154	81	S03AD4114	80
R48115C	38	S03A4112	80	S03A6155	81	S03AD4115	80
R51	Pág.	S03A4113	80	S03A6156	81	S03AD4116	80
R5103	45	S03A4114	80	S03A6157	81	S03AD4117	80
R5103RK	45	S03A4115	80	S03A6158	81	S03AD4118	80
R5104	45	S03A4116	80	S03A6159	81	S03AD4119	80
R5104RK	45	S03A4117	80	S03A6160	81	S03AD4120	80
R53	Pág.	S03A4118	80	S03A6163	81	S03AD4121	80
R53A-2A	78	S03A4119	80	S03A6165	81	S03AD4122	80
R53A-3A	78	S03A4120	80	S03A6167	81	S03AD4123	80
R53A-4A	78	S03A4121	80	S03A6170	81	S03AD4124	80
R58	Pág.	S03A4122	80	S03A6A4	84	S03AD4125	80
R5802ERK	45	S03A4122KV	36	S03A6A8	84	S03AD4126	80
R5803RK	45	S03A4122SP	29	S03A6E04	84	S03AD4127	80
R5804ERK	45	S03A4123	80	S03A6E08	84	S03AD4128	80
R5804LRK	45	S03A4124	80	S03A6E10	84	S03AD4130	80
R66	Pág.	S03A4127	80	S03A6U6	84	S03AD4132	80
R6602	45	S03A4129	80	S03A8109S	84	S03AD4303S	86
R6603	45	S03A4130	80	S03A8124	82	S03AD4307S	86
R6604	45	S03A4132	80	S03A8127	82	S03AD4317	86
R68	Pág.	S03A4211S	79	S03A8129	82	S03AD4319	86
R6802	45	S03A4A3	78	S03A8130	82	S03AD4321	86
R6802RK	45	S03A4A6	78	S03A8132	82	S03AD4414S	79
R6803	45	S03A4E4	79	S03A8133	82	S03AD4517	86
R6803RK	45	S03A4E5	79	S03A8134	82	S03AD4519	86
R6804	45	S03A4E6	79	S03A8135	82	S03AD4521	86
R6804RK	45	S03A4E8	79	S03A8136	82	S03AD6107S	79
RD0	Pág.	S03A4U4	79	S03A8138	82	S03AD6120S	79
RD01	45	S03A4UT	79	S03A8140	82	S03AD6124	82
RD01032S	102	S03A4UT3S	79	S03A8141	82	S03AD6126	82
RD02	45	S03A6108S	79	S03A8144	82	S03AD6127	82
RD05H2	102	S03A6126	81	S03A8146	82	S03AD6129	82
RD0638S	102	S03A6127	81	S03A8150	82	S03AD6130	82
RV0	Pág.	S03A6129	81	S03A8155	82	S03AD6132	82
RV032	116	S03A6130	81	S03A8160	82	S03AD6133	82
RV033	116	S03A6132	81	S03A8165	82	S03AD6134	82
RV034	116	S03A6133	81	S03A8170	82	S03AD6135	82
S01U	Pág.	S03A6134	81	S03A8173	82	S03AD6136	82
S01U4108S	78	S03A6135	81	S03A8175	82	S03AD6138	82
S01U4113	78	S03A6136	81	S03A8176	82	S03AD6140	82
S01U4114	78	S03A6137	81	S03A8178	82	S03AD6141	82
S01U4115	78	S03A6138	81	S03A8180	82	S03AD6142	82
S01U4116	78	S03A6139	81	S03A8185	82	S03AD6144	82
S01U4117	78	S03A6140	81	S03A8189	82	S03AD6146	82
S01U4119	78	S03A6141	81	S03A8190	82	S03AD6150	82
S01U4121	78	S03A6142	81	S03A8192	82	S03AD8107S	84
S01U4122	78	S03A6143	81	S03A8195	82	S03AD8117	83
S03A	Pág.	S03A6144	81	S03A8A6	84	S03AD8124	83
S03A2110	78	S03A6145	81	S03A8E04	84	S03AD8126	83
S03A2112	78	S03A6146	81	S03A8E07	84	S03AD8127	83
S03A2114	78	S03A6147	81	S03A8E10	84	S03AD8129	83

S03AD8130	83	S04H	Pág.	S04H4121	62	S04H6330	64
S03AD8132	83	S04H2104	61	S04H4122	62	S04H6332	64
S03AD8133	83	S04H2104S	61	S04H4123	62	S04H6334	64
S03AD8134	83	S04H2105	61	S04H4124	62	S04H6336	64
S03AD8135	83	S04H2105S	61	S04H4125	62	S04H6338	64
S03AD8136	83	S04H2106	61	S04H4125S	57	S04H6341	64
S03AD8138	83	S04H2107	61	S04H4125SP	29	S04H6346	64
S03AD8140	83	S04H2108	61	S04H4126	62	S04H6350	64
S03AD8141	83	S04H2109	61	S04H4127	62	S04H6355	64
S03AD8142	83	S04H2110	61	S04H4128	62	S04H6356	64
S03AD8146	83	S04H2111	61	S04H4129	62	S04H6360	64
S03AD8148	83	S04H2112	61	S04H4130	62	S04H6365	64
S03AD8150	83	S04H2113	61	S04H4131SP	30	S04H6419	64
S03AD8155	83	S04H2114	61	S04H4132	62	S04H6421	64
S03AD8158	83	S04H2118S	56	S04H4134	62	S04H6422	64
S03AD8160	83	S04H2125SP	29	S04H4136	62	S04H6424	64
S03AD8165	83	S04H2132KV	36	S04H4144KV	36	S04H6426	64
S03H	Pág.	S04H2141S	56	S04H42165SV	33	S04H6427	64
S03H2327S	56	S04H2184SV	33	S04H4295SV	33	S04H6429	64
S03H2353S	56	S04H3106	61	S04H4524S	57	S04H6430	64
S03S	Pág.	S04H3107	61	S04H4524SP	30	S04H6432	64
S03S8117	84	S04H3108	61	S04H46121SV	34	S04H6433	64
S03S8119	84	S04H3109	61	S04H4726SP	30	S04H6435	64
S03S8121	84	S04H3110	61	S04H4728S	57	S04H6436	64
S03S	Pág.	S04H3111	61	S04H4728SP	30	S04H6438	64
S03SD8117	84	S04H3112	61	S04H5129SC	38	S04H6440	64
S03SD8119	84	S04H3113	61	S04H524127S	60	S04H6441	64
S03SD8121	84	S04H3114	61	S04H52460S	59	S04H6443	64
S03V	Pág.	S04H3115	61	S04H52477S	59	S04H6444	64
S03V2106	118	S04H3116	61	S04H52478S	59	S04H6446	64
S03V2108	118	S04H3117	61	S04H6115S	57	S04H6447	64
S03V2110	118	S04H3118	61	S04H6119	63	S04H6450	64
S03V2114	118	S04H3119	61	S04H6121	63	S04H6456	64
S03V3108	119	S04H3120	61	S04H6122	63	S04H8115S	58
S03V3110	119	S04H3121	61	S04H6124	63	S04H8355	65
S03V3112	119	S04H3122	61	S04H6127	63	S04H8360	65
S03V3113	119	S04H3124	61	S04H6128	63	S04H8365	65
S03V3114	119	S04H3125S	56	S04H6130	63	S04HD	Pág.
S03V3116SC	119	S04H3141S	56	S04H6132	63	S04HD2105	61
S03V3117	119	S04H3157S	57	S04H6134	63	S04HD2106	61
S03V3119	119	S04H3157SP	29	S04H6136	63	S04HD2107	61
S03V3122	119	S04H3194SV	33	S04H6138	63	S04HD2108	61
S03V3136SV	119	S04H3536S	57	S04H6141	63	S04HD2109	61
S03V4110	119	S04H3536SP	29	S04H6146	63	S04HD2110	61
S03V4111	119	S04H4108	62	S04H6150	63	S04HD2111	61
S03V4112	119	S04H4109	62	S04H6152	63	S04HD2112	61
S03V4113	119	S04H4110	62	S04H624101S	59	S04HD2113	61
S03V4114	119	S04H4111	62	S04H6319	64	S04HD3109	62
S03V4117	119	S04H4112	62	S04H6321	64	S04HD3110	62
S03V4119	119	S04H4113	62	S04H6321S	57	S04HD3111	62
S03V4120SC	119	S04H4114	62	S04H6322	64	S04HD3112	62
S03V4122	119	S04H4115	62	S04H6323	64	S04HD3113	62
S03V4124	119	S04H4116	62	S04H6324	64	S04HD3114	62
S03V4124SV	119	S04H4117	62	S04H6325	64	S04HD3115	62
S03V4127	119	S04H4118	62	S04H6326	64	S04HD3116	62
S03V4132	119	S04H4119	62	S04H6327	64	S04HD3117	62
		S04H4120	62	S04H6329	64	S04HD3119	62

S04HD3120	62	S05HD4119	65	S07H207	69	S09H303	70
S04HD3121	62	S05HD4120	65	S07H208	69	S09H304	70
S04HD3124	62	S05HD4121	65	S07H209	69	S09H305	70
S04HD4109	63	S05HD4122	65	S07H210	69	S09H306	70
S04HD4110	63	S05HD4123	65	S07H2138KV	36	S09H307	70
S04HD4111	63	S05HD4124	65	S07H215	69	S09H308	70
S04HD4112	63	S05HD4127	65	S07H220	69	S09H310	70
S04HD4113	63	S05HD4130	65	S07H225	69	S09H312	70
S04HD4114	63	S05HD4132	65	S07H227	69	S09H314	70
S04HD4115	63	S05HD4213S	66	S07H230	69	S09H404	71
S04HD4116	63	S06A	Pág.	S07H240	69	S09H405	71
S04HD4117	63	S06A408S	85	S07H310	69	S09H406	71
S04HD4118	63	S06A4T20	85	S07H315	69	S09H407	71
S04HD4119	63	S06A4T27	85	S07H320	69	S09H408	71
S04HD411S	66	S06A4T30	85	S07H325	69	S09H410	71
S04HD4120	63	S06A4T40	85	S07H327	69	S09H4109S	58
S04HD4121	63	S06A4T45	85	S07H330	69	S09H4118SP	30
S04HD4122	63	S06A4T50	85	S07H340	69	S09H412	71
S04HD4123	63	S06A4T55	85	S07H345	69	S09H414	71
S04HD4124	63	S06A4T60	85	S07H350	69	S09H416	71
S04HD4125	63	S06A4T70	85	S07H355	69	S09H417	71
S04HD4126	63	S06A4T80	85	S07H360	69	S09H419	71
S04HD4127	63	S06H	Pág.	S07H4109S	58	S09H4304	71
S04HD4128	63	S06H204	68	S07H420	69	S09H4305	71
S04HD4130	63	S06H205	68	S07H425	69	S09H4306	71
S04HD4132	63	S06H206	68	S07H427	69	S09H4307	71
S05A	Pág.	S06H207	68	S07H430	69	S09H4308	71
S05A408S	84	S06H208	68	S07H4320	70	S09H4309	71
S05A416S	84	S06H210	68	S07H4325	70	S09H4310	71
S05A4H10	83	S06H211	68	S07H4327	70	S09H4312	71
S05A4H12	83	S06H306	68	S07H4330	70	S09H4314	71
S05A4H14	83	S06H307	68	S07H4340	70	S09H4316	71
S05A4H17	83	S06H308	68	S07H4345	70	S09H4317	71
S05A4H18	83	S06H310	68	S07H4350	70	S09H4319	71
S05A4H19	83	S06H311	68	S07H4352	70	S09V	Pág.
S05A4H4	83	S06H312	68	S07H4355	70	S09V3H4	119
S05A4H5	83	S06H314	68	S07H4360	70	S09V3H5	119
S05A4H6	83	S06H316	68	S07H4370	70	S09V3H6	119
S05A4H7	83	S06H318	68	S07H440	69	S09V3H8	119
S05A4H8	83	S06H320	68	S07H445	69	S09V41H10	119
S05A6105S	84	S06H37S	66	S07H450	69	S09V41H4	119
S05A6H14	85	S06H410	68	S07H4530	73	S09V41H5	119
S05A6H17	85	S06H411	68	S07H4540	73	S09V41H6	119
S05A6H19	85	S06H412	68	S07H4545	73	S09V41H8	119
S05A6H22	85	S06H4127S	58	S07H455	69	S10H	Pág.
S05A6H24	85	S06H414	68	S07H460	69	S10H230	71
S05H	Pág.	S06H416	68	S07H470	69	S10H235	71
S05H4113S	66	S06H418	68	S07H4932S	58	S10H240	71
S05H4213S	66	S06H420	68	S08H	Pág.	S10H245	71
S05HD	Pág.	S06H422	68	S08H208S	102	S10H250	71
S05HD4110	65	S06H424	68	S08H311S	73	S10H255	71
S05HD4111	65	S06H425S	58	S09H	Pág.	S10H260	71
S05HD4112	65	S06H427KV	36	S09H203	70	S10H270	71
S05HD4113	65	S06H427SP	30	S09H204	70	S10H3100	72
S05HD4113S	66	S06H49S	66	S09H205	70	S10H3120	72
S05HD4117	65	S07H	Pág.	S09H206	70	S10H340	72
S05HD4118	65	S07H206	69	S09H207	70	S10H350	72

S10H355	72	S18A4115	87	S25V410	120	S49H4310	73
S10H360	72	S18A4117	87	S25V45	120	S49H4312	73
S10H370	72	S18A4117M	86	S26H	Pág.	S49H4314	73
S10H380	72	S18A4119	87	S26H2150	76	S49H4318	73
S10H4100	72	S18A4119M	86	S26H2280	76	S50H	Pág.
S10H4110	72	S18A4121	87	S27H	Pág.	S50H3106S	73
S10H4120	72	S18A4121M	86	S27H2	77	S50H3206S	73
S10H480	72	S18AD	Pág.	S27H3	77	S54H	Pág.
S10H490	72	S18AD4103S	86	S27H4	77	S54H5509S	73
S11H	Pág.	S18AD4117	87	S29H	Pág.	S57H	Pág.
S11H200	72	S18AD4119	87	S29H2133S	102	S57H108	51
S11H201	72	S18AD4121	87	S29H2180S	106	S57H108S	51
S11H202	72	S21H	Pág.	S29H4140SP	30	S57H109	51
S11H203	72	S21H41125	76	S29H4141KV	36	S57H110	51
S11H300	72	S21H41250	76	S29T	Pág.	S57H111	51
S11H301	72	S21H4150	76	S29TP23S	102	S57H112	51
S11H302	72	S21H4175	76	S40H	Pág.	S57H113	51
S11H303	72	S22H	Pág.	S40H108	77	S57H115	51
S11H304	72	S22H21150	76	S40H110	77	S57H116	51
S11H402	72	S22H21130RK	76	S40H112	77	S57H117	51
S11H403	72	S22H31200	76	S40H114	77	S57H118	51
S11H404	72	S22H31200RK	76	S40T	Pág.	S57H119	51
S12A	Pág.	S22H41375	76	S40T108	77	S57H121	51
S12A4525S	85	S22H41375RK	76	S40T109S	77	S57H122	51
S14A4108S	103	S22H41450	76	S40T110	77	S57H123	51
S14A4117	103	S22H41600	76	S40T112	77	S57H124	51
S14A4118	103	S22H41600RK	76	S40T113	77	S57H125	51
S14A4120	103	S22H6500	76	S40T114	77	S57H127	51
S14A4121	103	S22H6500RK	76	S40T117	77	S57H132	51
S14A4123	103	S23H	Pág.	S40T119	77	S60H	Pág.
S14A4124	103	S23H21115	76	S40TB-1	77	S60H4304S	78
S14A4126	103	S23H31200	76	S41H	Pág.	S63H	Pág.
S14A4127	103	S23H41250	76	S41H41	77	S63H3306	73
S15H	Pág.	S23H41300	76	S42M	Pág.	S63H3307	73
S15H240	75	S23H6450	76	S42M403S	77	S63H3308	73
S15H356	75	S23H6500	76	S42M4125	77	S63H3310	73
S15H472	75	S23H8550	76	S42M4250	77	S63H4132S	58
S15H6109	75	S24H	Pág.	S42M475	77	S63H4306	73
S16H	Pág.	S24H2100	76	S43V	Pág.	S63H4307	73
S16H1234	75	S24H2150	76	S43V38	116	S63H4308	73
S16H1238	75	S24H250	76	S43V48	116	S63H4310	73
S16H1438	75	S24H3150	76	S44H	Pág.	S63H4312	73
S16H302	75	S24H3200	76	S44H2206	77	S63H4313	73
S16H304	75	S24H3250	76	S44H3110A	77	S63H4405	73
S16H3410	75	S24H375	76	S44H3206	77	S63H4405	73
S16H3412	75	S24H4125	76	S44H4110	77	S63H4407	73
S16H3812	75	S24H4224	76	S46T	Pág.	S63H4407	73
S16H3814	75	S24H4250	76	S46TE80	86	S63H4408	73
S16H403	75	S24H450	76	S49H	Pág.	S63H4408	73
S17H	Pág.	S24H475	76	S49H4105	73	S63H4409	73
S17H3116	75	S24H6100	76	S49H4106	73	S63H4409	73
S17H3121	75	S24H6200	76	S49H4108	73	S63H4410	73
S17H3414	76	S24H6400	76	S49H4110	73	S63H4412	73
S17H4116	75	S24H8200	76	S49H4112	73	S63H4413	73
S17H4121	75	S25V	Pág.	S49H4114	73	S63H4414	73
S18A	Pág.	S25V310	120	S49H4116	73	S63H4507S	74
S18A4103MS	86	S25V36	120	S49H4308	73	S63H4605	74

S63H4606	74	S64H4812	74	S68H2111	54	T21341N-R	43
S63H4607	74	S64H4814	74	S68H2112	54	T21550N	42
S63H4608	74	S66H	Pág.	S68H2113	54	T21550N-R	43
S63H4609	74	S66H4108	66	S68H2114	54	T24	Pág.
S63H4610	74	S66H4109	66	S68H2141S	54	T24135	43
S63H4612	74	S66H4110	66	S68H4127S	54	T24135-R	43
S63H4613	74	S66H4111	66	S68H5234111S	55	T24200	43
S63H4614	74	S66H4112	66	T04	Pág.	T24200-R	43
S63H4708	74	S66H4113	66	T04M060-R	43	T25	Pág.
S63H4709	74	S66H4114	66	T04M061-R	43	T25100N	42
S63H4710	74	S66H4115	66	T04M150-R	43	T25100N-R	43
S63H4712	74	S66H4116	66	T04M250-R	43	T25200N	44
S63H4713	74	S66H4117	66	T07	Pág.	T25200N-R	43
S63H4714	74	S66H4118	66	T07030N-R	43	T25340N	42
S63H4808	74	S66H4119	66	T07110N-R	43	T25340N-R	43
S63H4809	74	S66H4120	66	T07700N-R	43	T27	Pág.
S63H4810	74	S66H4121	66	T09	Pág.	T27-D2R	43
S63H4812	74	S66H4122	66	T094602	45	T27-D3R	43
S63H4813	74	S66H4124	66	T094602-RK	45	T27-D4R1	43
S63H4814	74	S66H4125	66	T096801	45	T27-D4R2	43
S64A	Pág.	S66H4126	66	T096801-RK	45	T27-D6R	43
S64A4106S	85	S66H4127	66	T10	Pág.	T27-D8R	43
S64A6116	85	S66H4128	66	T102001S-R	43	T27010N	42
S64A6118	85	S66H4130	66	T10314	42	T27020N	42
S64A6306S	85	S66H4132	66	T10315	42	T27021N	42
S64A6T70	85	S66H4136	66	T10316	42	T27060N	42
S64A6T90	85	S66HD	Pág.	T10317	42	T271001N	42
S64H	Pág.	S66HD4110	67	T10318	42	T27101N	42
S64H4104	74	S66HD4111	67	T10319	42	T27200N	42
S64H4105	74	S66HD4112	67	T10321	42	T27340N	42
S64H4106	74	S66HD4113	67	T10322	42	T27800N	42
S64H4107	74	S66HD4114	67	T10H1210S	42	T29	Pág.
S64H4109	74	S66HD4115	67	T14	Pág.	T29002	42
S64H4112	74	S66HD4116	67	T14200N	43	T29014	42
S64H4113	74	S66HD4117	67	T15	Pág.	T29016	42
S64H4114	74	S66HD4118	67	T154100N-R	43	T30	Pág.
S64H4126S	58	S66HD4119	67	T154200N-R	43	T30200NS	42
S64H4204	74	S66HD4120	67	T16	Pág.	T31	Pág.
S64H4205	74	S66HD4121	67	T16005N-R	43	T31313	42
S64H4206	74	S66HD4122	67	T19	Pág.	T31324	42
S64H4207	74	S66HD4123	67	T19135N	43	T31332	42
S64H4208	74	S66HD4124	67	T19200N	43	T33	Pág.
S64H4209	74	S66HD4127	67	T19600N	43	T33025N	42
S64H4210	74	S66HD4130	67	T21	Pág.	T33025N-R	43
S64H4212	74	S66HD4132	67	T21025N	42	T33050N	42
S64H4214	74	S68H	Pág.	T21025N-R	43	T33050N-R	43
S64H4216	74	S68H2103	54	T21050N	42	T33101N	42
S64H4218	74	S68H2104	54	T21050N-R	43	T33101N-R	43
S64H4705	74	S68H2104S	54	T211000N	42	T33200N	42
S64H4706	74	S68H2105	54	T211000N-R	43	T33200N-R	43
S64H4708	74	S68H2105S	54	T21101N	42	T33341N	42
S64H4709	74	S68H2106	54	T21101N-R	43	T33341N-R	43
S64H4710	74	S68H2106S	54	T21200N	42	T35	Pág.
S64H4712	74	S68H2107	54	T21200N-R	43	T351060	45
S64H4714	74	S68H2108	54	T21340N	42	T41	Pág.
S64H4808	74	S68H2109	54	T21340N-R	43	T41-SK	43
S64H4810	74	S68H2110	54	T21341N	42	T41200N	42

T41200N-R	43	W231415	49	W25108S	50	W26116SP	31
T41340N	42	W231617	49	W25110KV	37	W26117	50
T41340N-R	43	W231719	49	W25110SP	31	W26118	50
V10	Pág.	W231819	49	W25117SC	38	W26119	50
V1001	92	W231922	49	W251213	50	W26120	50
V1002	92	W232022	49	W251214	50	W26121	50
V1002-RK	92	W232123	49	W251415	50	W26122	50
V1003	92	W232224	49	W251417	50	W26123	50
V1003-RK	92	W232426	49	W251617	50	W26124	50
V1005	92	W232427	49	W251618	50	W26125	50
V11	Pág.	W232528	49	W251719	50	W26126	50
V11011SC	38	W233032	49	W251819	50	W26126S	50
V1103	92	W23559SV	34	W251922	50	W26127	50
V13	Pág.	W23V108	120	W252022	50	W26128	50
V1310A-11	93	W23V110	120	W252123	50	W26129	50
V1310B-11	93	W23V111	120	W252224	50	W26130	50
V1310E-11	93	W23V112	120	W252426	50	W26132	50
V1310F	93	W23V113	120	W252427	50	W26134	50
V1310F-11	93	W23V114	120	W252528	50	W26134SV	34
V1310G-11	93	W23V116	120	W252730	50	W26136	50
V1310J-11	93	W23V117	120	W252732	50	W26138	50
V1311A	93	W23V118	120	W253032	50	W26141	50
V1311C	93	W23V119	120	W253236	50	W26142	50
V1311E	93	W23V121	120	W253641	50	W26144	50
V1311SP	31	W23V122	120	W253842	50	W26146	50
V14	Pág.	W23V124	120	W254146	50	W26148	50
V1401	93	W24	Pág.	W254650	50	W26150	50
V1403	93	W240809	49	W25V108	120	W26155	50
V15	Pág.	W241011	49	W25V109	120	W26160	50
V1501	93	W241012	49	W25V110	120	W26165	50
V1505	93	W241065	50	W25V1125SV	120	W2623431SV	34
V21	Pág.	W241213	49	W25V113	120	W26315SV	34
V2101	92	W241214	49	W25V114	120	W26411PRS	51
V2102	92	W241314	49	W25V117	120	W26414S	51
V2102-RK	92	W241417	49	W25V118	120	W27	Pág.
V24	Pág.	W241617	49	W25V119	120	W27AK8	53
V2401	92	W241719	49	W25V121	120	W27AL10	53
V2401-M10A	92	W241819	49	W25V122	120	W27AR10	53
V2401-M10B	93	W241922	49	W25V124	120	W27AR8	53
V2401-M5A	92	W242224	49	W26	Pág.	W27AS10	53
V2401-M5B	93	W242427	49	W26106	50	W27AS15	53
V2401-M6A	92	W242528	49	W26107	50	W27AS18	53
V2401-M6B	93	W243032	49	W26108	50	W27AS8	53
V2401-M8A	92	W24A107S	46	W26108KV	37	W27AT02SC	38
V2401-M8B	93	W24A109SP	31	W26109	50	W27AT10	53
W10	Pág.	W24N0810	49	W26110	50	W27AT12	53
W106115SP	31	W24N1113	49	W26110KV	37	W27AT15	53
W23	Pág.	W24N1214	49	W26111	50	W27AT8	53
W230607	49	W24N1719	49	W26112	50	W28	Pág.
W230809	49	W25	Pág.	W26112S	50	W2808	54
W230810	49	W250607	50	W26112SP	31	W2810	54
W231011	49	W250608	50	W26113	50	W2810RJ-HL	54
W23108S	49	W250809	50	W26114	50	W2812	54
W23108SP	31	W251011	50	W26114S	50	W2812RJ-HL	54
W231113	49	W251012	50	W26115	50	W2814	54
W231213	49	W25106KV	37	W26116	50	W2814RJ-HL	54
W231317	49	W25107KV	37	W26116KV	37	W2818	54

W2818RJ-HL	54	W45316S-ADBH14	47	W66119	47	W77A130	52
W2824	54	W47	Pág.	W66121	47	W77A132	52
W2824RJ-HL	54	W47108SP	31	W66124	47	W77A136	52
W2836	54	W51	Pág.	W67	Pág.	W77A138	52
W2836RJ-HL	54	W51110S	47	W67104S	47	W77A141	52
W28HD8	54	W52	Pág.	W67119	53	W77A146	52
W29	Pág.	W52105S	47	W67121	53	W77A150	52
W290608	51	W61	Pág.	W67124	53	W77A155	52
W290711	51	W611011	48	W67130	53	W77A160	52
W291012	51	W61106S	49	W67132	53	W77A165	52
W291418	51	W611214	48	W67136	53	W77H01	52
W291622	51	W61131S	48	W67138	53	W77H02	52
W292024	51	W611618	48	W67141	53	W77H03	52
W39	Pág.	W611719	48	W67145	53	W77H04	52
W391011	51	W612224	48	W67146	53	W84	Pág.
W39108SA	51	W62	Pág.	W67150	53	W84106	55
W391213	51	W6210607	49	W67155	53	W84107	55
W39141S	51	W6210809	49	W67160	53	W84108	55
W391617	51	W62108S	49	W67165	53	W84108S	55
W391819	51	W6211011	49	W67170	53	W84109	55
W43	Pág.	W6211213	49	W68	Pág.	W84110	55
W43A0607	52	W621141S	49	W680809	47	W84111	55
W43A0809	52	W6211617	49	W680810	47	W84112	55
W43A1011	52	W6211819	49	W681011	47	W84113	55
W43A106S	52	W6212022	49	W68106S	48	W84114	55
W43A1213	52	W6212427	49	W681213	47	W84114S	55
W43A141S	52	W6212528	49	W68141S	47	W84115	55
W43A1617	52	W6213032	49	W681618	47	W84116	55
W43A1819	52	W65	Pág.	W681719	47	W84117	55
W45	Pág.	W65105KV	37	W69	Pág.	W84118	55
W45108	46	W6510810	51	W69116S	51	W84119	55
W45109	46	W6511012	51	W70	Pág.	W86112S	55
W45110	46	W651131S	51	W70A118S	31	W91	Pág.
W45110S	46	W6511417	51	W72	Pág.	W91107S	48
W45111	46	W6511922	51	W72117	53	W91110	48
W45112	46	W65A1012	52	W72118	53	W91112	48
W45112SP	31	W65A105S	52	W72119	53	W91113	48
W45113	46	W65A1214	52	W72121	53	W91114	48
W45114	46	W65A131S	52	W72122	53	W91115	48
W45115	46	W65A1618	52	W72124	53	W91117	48
W45116	46	W65A1719	52	W72127	53	W91119	48
W45117	46	W65A1922	52	W72130	53	W93	Pág.
W45117S	46	W65A2224	52	W72132	53	W93108S	48
W45118	46	W66	Pág.	W72134	53	W93110	48
W45119	46	W66107S	47	W72136	53	W93111	48
W45121	46	W66108	47	W72141	53	W93112	48
W45122	46	W66109	47	W72146	53	W93113	48
W45124	46	W66110	47	W72150	53	W93114	48
W45127	46	W66111	47	W72155	53	W93115	48
W45130	46	W66112	47	W72170	53	W93117	48
W45132	46	W66113	47	W73	Pág.	W93119	48
W45316S	46	W66114	47	W73102S	48	WFS	Pág.
W45316S-AD	46	W66115	47	W7310813	48	WFS46	52
W45316S-AD12	46	W66116	47	W7311419	48	WV2	Pág.
W45316S-AD14	46	W66116S	47	W77	Pág.	WV27AS10	120
W45316S-AD34	46	W66117	47	W77A124	52		
W45316S-AD38	47	W66118	47	W77A127	52		

ARTIGO	PÁG.	ARTIGO	PÁG.
Acessórios de ar comprimido	187 a 189	Chave inglesa	53
Acessórios para carros ferramenta	23 e 24	Chave luneta	48; 49; 50; 51; 52
Alavancas de chapeiro	162	Chave mista	50; 51
Alicate anéis de segurança	137	Chave com roquete	46 a 48
Alicate ajustável	88; 90; 91	Chave para bujão óleo	138; 140
Alicate anti estático	91	Chave pata de galo	78
Alicate corta cabos	91	Chaves alternador	133
Alicate de cravar terminais	93	Chave cavilhas e encaixes plásticos	161; 162
Alicate de descarnar	90; 93	Chaves de caixa	61 a 67
Alicate de freios	88; 89	Chaves de fenda	96 a 100
Alicate de pressão	94; 95	Chaves de filtros	138; 139
Alicate de rebitar	92	Chaves de impacto	78 a 87
Alicate para abraçadeiras	134; 137; 148; 149	Chaves de velas incandescência	135
Alicates (universal, pontas, corte)	88 a 90	Chaves dinamométricas	42; 43
Alicates para tubos	137; 143; 146	Chaves em L hexagonais	106 a 110
Alicate para tubos escape	146	Chaves em L Torx	107 a 109
Alicate para tubos radizador	149	Chaves em T com ponta flexível	77
Alicate tensor abraçadeiras	145	Chave flexível de punho	77
Alicates travões	144	Chaves Phillips	96 a 100
Apalpa folgas	142	Chaves Pozi	98; 100
Aparafusadora pneumática	174; 175	Chave remoção frisos/ plásticos	160; 161
Aparadeira óleo	122; 201	Chave remoção vidros/ pábrabras	160
Assentador pneumático de válvulas	182	Chaves retirar fêmeas danificadas	102; 103
Balanceiros	186	Chave de rodas em cruz	129
Bancada de trabalho	201	Chaves sensor oxigénio	141
Banco de apoio	199	Chaves SuperTech	54; 55
Bandeja magnética	128	Chaves Torx	98
Berberquim pneumático	173; 174	Chaves Torx plus	102
Bits de caixa	68 a 74	Chave para terminais	132
Bits e porta bits	104 a 106	Compasso	115
Bomba de massa	186	Compressor molas	126
Bomba hidropneumática	198	Corta tubos	146; 147
Cabo articulado (rabo de força)	76	Cunhas chapeiro	162
Cabo T corrediço	76	Densímetro	148
Cabos arranque de bateria	148	Desandadores	163; 164
Caixas de ferramenta	54 a 60	Despolidor de cilindros	147
Caneta magnética	128	Detetor de fugas cilindros	127
Cardan	75	Encontrador de chapeiro	162; 163
Carros e caixas vazios	19 a 21	Enroladores de ar	187
Carros e composições de ferramenta	7 a 18	Estrado de mecânico	199
Centrador embraiagens	145	Esquadro metálico	115
Chave bocas	50	Extensões	76; 77
Chave de barra direção	146	Extratores	124
Chave de bocas perfil fino	51	Extrator de juntas	133
Chave de cachimbo	51	Faca pneumática	183
Chave de injetores	136	Ferramenta ajuste eixo traseiro	146
Chave de pancada (bocas e luneta)	53	Ferramenta isolada 1000Volts	116 a 120
Chave de tubos	54	Ferramenta para correias	142
Chave de tubos combustível	137	Ferramenta para travões	144
Chave de velas	75; 141	Ferramenta rodar válvulas	136

ARTIGO	PÁG.	ARTIGO	PÁG.
Ferramentas chapeiro	160 a 165	Porta bits	106
Ferramentas especiais mecânica	122 a 158	Porta caçonetos	130
Ferramentas especiais motas	159; 160	Preguiças	122; 200
Ferramentas especiais pesados	165; 166	Prensas de chapeiro	200
Ferramentas especiais por marca	150 a 155	Punções	112; 113
Ferro de desmonta	146	Punho para chave caixa	76
Filtros de ar	188; 189	Raspadores/ riscadores	136
Fita métrica	114	Rebarbadora pneumática	177
Funil para óleos e refrigerante	142	Rebitadora pneumática	185; 186
Gambiarra sem fios	129	Rectificadora pneumática	175; 176
Grampo segmentos	133	Reduções	75
Grampo válvulas	133	Refratómetro	126
Grua hidráulica	199	Régua metálica	115
Jogo de bits	101; 102	Régua verificação empenos motor	131
Jogo chaves caixa com roquete	56 a 58	Reparador de roscas	142; 143
Kit comando motores	132; 150 a 152	Roquete pneumático	172; 173
Kit remoção de rádios	149	Roquetes	44; 45
Limas	114	Saca casquilhos	128
Lixadora pneumática	177 a 179	Saca injectores	133; 135
Macaco de chapeiro	200	Sacas	124; 125
Macaco de fossa/ transmissões	198	Sangrador travões	123; 137
Macaco de rodas/ hidropneumático	199	Seringa	127
Machos e caçonetos	26; 38; 130	Serra	114
Mala de electricista	148	Serra pneumática	182
Mala de ferramenta	58 a 60	Suporte de motores	199
Máquina decapar pneumática	183	Suporte movimentação rodas/pneus	199
Máquina descavar pneumática	175	Suporte para chaves caixa	74
Máquina pneumática impacto	168 a 171	Tabuleiros ferramenta (caixa plástico)	26 a 31
Martelo pneumático	185	Tabuleiros ferramenta (EVA)	32; 37
Martelos	111	Tabuleiros vazios	39 a 41
Martelos de chapeiro	163	Tesoura	91
Medidor angular de torque	129	Tesoura pneumática	184
Medidor discos travão	147	Teste atuadores	148
Medidor de passo de rosca	129	Teste compressão/ pressão	134
Medidor de profundidade	147	Teste de vácuo/ pressão	137
Medidor de pressão pneus	128	Teste fluido travões	148
Merchandising	192 a 195	Teste fluxo e retorno injectores	134
Micrómetro	115	Teste pressão radiadores	122
Molas de plástico	162	Teste turbo	135
Multímetros	201	Tira mossas	164
Organizador de peças	133	Tomadas de ar	189
Paquímetro	115	Torno de bancada	24
Pesca magnético	128	Travessa para portas	196
Pinça amperimétrica	201	Travessa para motores	195; 196
Pinças de chapeiro	164	Tubo espiral para ar	189
Pistola de pintura	180; 181	Turquês	91
Pistola vaporizadora (tornado)	127	Ventosas	161
Pistoletes ar/ água	187	Verificador altura calços travão	145
Polidora pneumática	177; 178	X-ato/ navalha	114
Ponteira para válvula pneus	128; 129		



Com ferramentas pneumáticas não utilizar chaves de caixa, juntas universais ou outras ferramentas de uso manual.



Não utilizar martelos ou tubos para aumentar o binário em chaves de aperto, chaves dinamométricas e roquetes.



Não utilizar chaves de parafusos como alavanca, punção ou escopro. Existem séries especiais de chaves de parafusos que podem ser marteladas.

Ferramentas Manuais

- Deverá ter bastante cuidado ao utilizar qualquer ferramenta, mantendo-a afastada das crianças.
- Recomenda-se utilizar sempre máscaras, óculos, auriculares e luvas de proteção (se aplicável).
- Deverá desligar sempre a energia elétrica antes de efetuar trabalhos em qualquer tipo de máquina ou equipamento elétrico ou junto de superfícies condutoras, pois poderão ocorrer choques elétricos. Nestes casos, utilizar sempre ferramentas isoladas.
- Deverá escolher o tipo e tamanho correto da ferramenta para o trabalho a realizar. As unidades de medida servem para selecionar a ferramenta com tamanho certo.
- Deverá manter as ferramentas limpas.
- Deverá ler as instruções antes de utilizar as ferramentas.
- Não deverá modificar nenhuma ferramenta.
- Nos carro de ferramentas, nunca deverá abrir mais do que uma gaveta de cada vez (perigo de tombar).
- Nos carro de ferramentas, nunca deverá usar uma gaveta como escada (perigo de tombar).
- Não deverá puxar de costas o carro de ferramentas.

Ferramentas Pneumáticas

As ferramentas pneumáticas Jonnesway permitem que os operadores usufruam de uma utilização segura, um desempenho excelente e reduzidas vibrações. As seguintes instruções de segurança são para as condições normais de utilização. Antes de utilizar as ferramentas pneumáticas, deverá ler com atenção estes avisos para evitar perigos desnecessários.

• Utilizar Proteção Pessoal

Deverá usar sempre proteção (como por exemplo máscaras, óculos, auriculares, luvas, etc.) quando manusear ferramentas pneumáticas de modo a evitar ferimentos.

• Evitar Danos Causados por Vibrações ou Movimentos de Trabalho Repetitivos

A exposição prolongada a vibrações ou a movimentos de trabalho repetitivos poderá ser prejudicial. Se sentir formigueiro, entorpecimento, desconforto ou dor, deverá parar de utilizar a ferramenta de imediato. Os operadores deverão seguir sempre as instruções a seguir indicadas:

- Utilizar as pegas do equipamento para garantir a sua rigidez e eficiência.
- Manter os pulsos o mais direito possível.
- Evitar movimentos muito repetitivos das mãos e pulsos.
- Manter as mãos e o corpo quentes e secos.
- Evitar a exposição contínua a vibrações por períodos muito prolongados.



• **Evitar os Perigos do Ar Comprimido**

- O ar sob pressão pode causar ferimentos. Por favor, observar as seguintes instruções de segurança para garantir um ambiente de trabalho seguro.
- Não direcionar o tubo do ar para si ou para outros. Deverá afastar o escape do ar de si próprio ou de outros.
- Antes de utilizar a ferramenta pneumática, verificar a existência de tubos e acessórios danificados ou soltos.
- Deverá desligar a ferramenta sempre que estiver a substituir acessórios, definir o aperto, efetuar reparações ou não estiver a ser utilizada.
- Deverá manter sempre a pressão do ar nos valores aconselhados, já que a utilização das ferramentas fora destes valores diminuirá o seu rendimento e a vida útil da ferramenta.
- Não ligar ferramentas pneumáticas a tomadas elétricas.
- Quando utilizar uniões universais de torção, deverão ser sempre instalados pinos/garfos de bloqueio para evitar que os tubos se desliguem acidentalmente.

• **Evitar Perigos Adicionais**

- Escorregadelas, tropeções e quedas são a causa principal de ferimentos e morte em acidentes de trabalho.
- Deverá ter cuidado com o excesso de tubos e cabos existentes na área de passagem ou na superfície de trabalho.
- Os operadores e técnicos de manutenção deverão estar fisicamente aptos para efetuar as suas tarefas e suportar o volume, peso e potência da ferramenta.
- Deverão ser utilizadas proteções nas rebarbadoras para reduzir o risco de cortes e escoriações devido às rebarbas.

Sistema Pneumático de Alimentação

- ① Filtro
- ② Drenagem
- ③ Secador de Ar
- ④ Depósito de Ar
- ⑤ Compressor de Ar
- ⑥ Filtro Regulador - Lubrificador

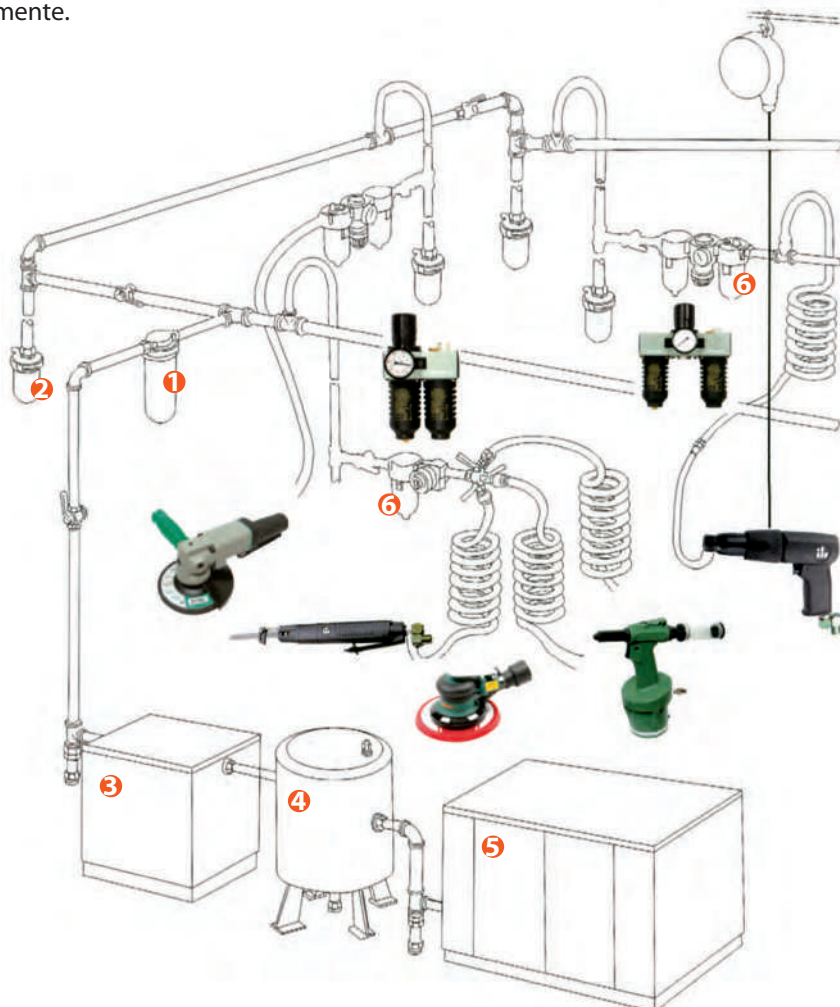

Recomendações de Manutenção

Quando ligar a ferramenta pneumática à rede de ar comprimido, deverá certificar-se que a pressão de alimentação desta deverá ser de 6.2kg/cm² (90PSI), já que se esta for demasiado elevada poderá danificar a ferramenta e se for demasiado baixa influenciará o funcionamento da mesma, reduzindo a sua vida útil.

- É recomendável a instalação dos filtros reguladores-lubrificadores adequados à ferramenta pneumática em uso. A entrada do ar deverá ter óleo lubrificante apropriado, de modo a lubrificar o motor interno da ferramenta. (Colocar um papel branco na saída do ar para verificar se existe uma sujidade gordurosa, que indique a existência de óleo suficiente).
- A entrada de ar não deverá ter água. Se tal ocorrer, recomenda-se a verificação ou instalação de um secador de ar.
- Não deverá desmontar a ferramenta, pois poderá danificá-la e afetar a segurança do utilizador.
- Mesmo que a ferramenta possua danos menores ou não efetue as funções indicadas pelo fabricante, não deverá utilizá-la até que seja inspecionada.
- Para manter o bom desempenho da ferramenta, deverá efetuar verificações regulares (semanalmente) e manutenções preventivas e lubrificações (adicionar massa lubrificante às peças rotativas e óleo lubrificante no motor).
- Sempre que utilizar as ferramentas pneumáticas deverá cumprir com as normas de segurança e instruções de funcionamento (quer aplicáveis à proteção do utilizador, quer à correta utilização da ferramenta).
- É essencial escolher as ferramentas certas e adequadas para o trabalho a realizar, já que se a ferramenta tiver uma potência muito elevada, poderá causar danos na peça em que está a trabalhar e se tiver pouca potência, poderá ficar danificada.

Condições Gerais de Garantia

A ferramenta manual e pneumática Jonnesway é fabricada com os mais elevados padrões de qualidade, mas é, para todos os efeitos, uma ferramenta de desgaste. É pois normal que a ferramenta sofra alteração de algumas características físicas durante o período de utilização, mesmo quando usada em condições normais.

Assim, a garantia da ferramenta fica dependente do conjunto das seguintes condições gerais:

- Para ferramentas manuais é oferecida uma garantia de “vida útil”, garantia esta que cobre defeitos de materiais e fabrico. Entende-se como “vida útil” o período de tempo de vida expectável para a peça de ferramenta em causa, desde que utilizada sempre nas condições normais de utilização e para as quais foi concebida.
- A gama de ferramentas pneumáticas e ferramentas de medição estão excluídas do ponto anterior. Os produtos foram desenhados e fabricados para uso profissional. O período de garantia é de um ano (12 meses) para uso profissional e de dois anos (24 meses) para uso particular. O período de garantia inicia-se à data da aquisição. Esta data deve ser verificada mediante a fatura de aquisição.
- Qualquer produto que tenha sido utilizado ou mantido de forma incorreta, que tenha sofrido um desgaste devido a uma utilização inadequada ou que tenha sido sujeito a alterações não autorizadas, não está coberto pela garantia.
- A ausência de manutenção preventiva ou a utilização de ar comprimido com pressão e lubrificação desajustadas são motivo para a perda imediata da garantia.



JONNESWAY



Certificate TW07/03377

The management system of

JONNESWAY ENTERPRISE CO., LTD.

6F-9, No. 51, Sec. 2, Keelung Rd, Taipei City

has been assessed and certified as meeting the requirements of

ISO 9001:2015

For the following activities

Design and trading management of JONNESWAY brand of professional hand tools, pneumatic tools, automobile repair tools, garage equipment and working machines.

This certificate is valid from 14 February 2022 until 14 February 2025 and remains valid subject to satisfactory surveillance audits. Recertification audit due a minimum of 60 days before the expiration date. Issue 7. Certified since 14 February 2007

Authorized by



SGS United Kingdom Ltd
Rosemead Business Park, Edgemoor Road, Chesham, Chesham, Chesham, UK
t+44 (0)151 250-8600 f+44 (0)151 250-8600 www.sgs.com

219C: 8001 2015 0421

Page 1 of 1







SGS

The document issued by the Certificate holder is the property of SGS Certification Services. It is not to be used for any other purpose, and its use is restricted to the specific scope of the certificate. The authority of the document may be verified at www.sgs.com. Any unauthorized use, reproduction, or distribution of this document is strictly prohibited. Any unauthorized alteration, forgery or falsification of the content or appearance of this document is illegal and punishable by law. Copyright © 2022 SGS



Ferramentas Pneumáticas



Carros, Armários e Composições



Ferramentas para Pintura e Chaparia



Ferramentas Isoladas a 1000V



Ferramentas para Automóveis

Importador para Portugal, França, Espanha, Angola e Cabo Verde



Lusilectra
Salvador Caetano

Rua Eng^o Ferreira Dias, 953/993 • 4100-247 Porto • Portugal
Tel. +351 226 198 750 • Email. lusilectra@lusilectra.pt
www.lusilectra.com • www.jonneswaytools.com

Distribuidor / Revendedor

