

Makita®



2020.10
GENERAL CATALOGUE
KATALOG PRODUK 综合产品目录



XGT

40V **Li-ion**
max





18V Lithium-ion



Teknologi Ekstrim Litium-ion
鋰离子技术

Rear Handle Saw

Recipro Saw

Slide Compound Miter Saw

Rotary Hammer

Stapler

Concrete Vibrator

Pin Nailer

Finish Nailer

Combination Hammer

Portable Cut-off

Shear Wrench

Angle Drill

Inflator

Fan

LED Worklight

LED Flashlight

Flashlight

Flashlight Radio

Area Worklight

Fan Jacket

Fan Vest

Heated Jacket

Heated Vest

Heated Blanket

Coffee Maker

Job Site Radio

Job Site Speaker

Blower

Chain Saw

Hedge Trimmer

Grass Shear

Grass Trimmer

String Trimmer

Cleaner

Cyclone Cleaner

Vacuum Cleaner

Portable Vacuum Cleaner

Robotic Cleaner

Trimmer

Planer

Drywall Saw

Cut-Out Tool

Jig Saw

Plate Joiner

18V LITHIUM-ION

18V Lithium-ion | 18V 锂离子



Chain Saw



Angle Grinder



Circular Saw



Plunge Cut Saw



Power Cutter



Pruning Shears



Blower



Vacuum Cleaner

Backpack Vacuum Cleaner



Multi Function Power Head



Auto Feed Screwdriver



Angle Drill



Angle Impact Wrench



Angle Impact Driver



Hammer Driver Drill



Rotary Hammer



Power Scraper



Impact Wrench



Screwdriver



Mixer



4 Mode Impact Driver



Driver Drill



Impact Driver



Oil-Pulse Driver

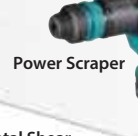

Combination Hammer



Metal Shear



Metal Cutter



Nibbler



Threaded Rod Cutter



Angle Grinder

18V x2

320+

TOOLS

6.0Ah 5.0Ah 4.0Ah
3.0Ah 2.0Ah 1.5Ah



Recipro Saw



Circular Saw



Slide Compound Miter Saw



Multi Tool



Steel Rod Cutter



Die Grinder



Random Orbit Sander



Compound Miter Saw



Drywall Sander



Power Scraper



Metal Shear



Metal Cutter



Nibbler



Threaded Rod Cutter



Angle Grinder

Expand Your Lithium Line Up

INDEX Indeks 索引

CORDLESS Tanpa Kord 充电式	26 - 113	4327	201	AT638A	208	DCL280FZW / ZB / Z NEW	127
LED FLASHLIGHT Lampu Suluh LED LED照明灯	114 - 118	4327M	201	B		DCL281FZW / ZB / Z	127
VACUUM CLEANER Pembersih Vakum 吸尘器	119 - 151	4329	200	BBC231URDE / Z BC231UDWBE	102	DCL500Z	124
DRILLING FASTENING Gerudi Pengetat 钻孔 紧固	152 - 157	4350CT	200	BBC300LRDE	102	DCL501Z	124
IMPACT DRILLING DEMOLITION Gerudi Pemecah 石工钻孔 凿壁加工	158 - 168	4351CT	200	BHR262RB3	101	DCM501Z	108
CUTTING Pematong 切割	169 - 175	4403	206	BHX2500	219	DCO180Z	79
GRINDING SANDING Pengisar Pelicin 研削 研磨	176 - 194	5		BML360Z	102	DCS231T	216
SAWING Gergaji 锯切	195 - 202	5008MG	198	BO3710	193	DCS520-53	215
PLANING ROUTERING Pengetam Tanggam 刨削 雕刻	203 - 206	5016B	214	BO4510H	193	DCS550RFE / Z	61
OTHERS Lain-lain 其他	207 - 210	5103N	199	BO4556	194	DCS551RFJ / Z	61
OUTDOOR POWER EQUIPMENT Alatan Kerja Luar 园林·户外	211 - 223	5402	199	BO4901	193	DCS552Z	61
Makita mt	224 - 233	5806B	198	BO5031	194	DCS553Z	61
1		6		BO5041	194	DCS6401-50	215
1805N	204	6016	153	BO6050J	194	DCS7301-60	215
1911B	203	6271DWE	103	BUC250RD	101	DCS7901-70	216
2		6305	152	BUH550RD / Z UH550DWB	101	DCS9010-76	216
2012NB	204	6413	152	BUH650RD / Z UH650DWB	102	DCU180Z	86
2107F	173	6905B	156	BUN490RD	102	DCV202YXL	112
2416S	174	6906	156	C		DDA351Z	55
2704	197	6922NB	157	CA5000X	175	DDA460ZK	33
2712	197	6924N	157	CB100DB	113	DDF083RTE / RFE / Z	47
3		9		CC300DW / Z	98	DDF453RME / RFE / SYE / Z	47
3501N	204	9031	192	CC301DWME / WAE / Z	93	DDF458RME / RFE / Z	46
3600H	206	9035H	193	CF100DZ	107	DDF459RME / Z	47
3612BR	206	9045B	193	CF101DZ	107	DDF481RTE / RME / RFE / Z	46
3709	205	9215SB	187	CG100DZA	94	DDF482RME / RFE / Z	46
3901	205	9237C	187	CL070DZ	131	DDF483RTE / RME / RFE / Z	47
4		9401	192	CL100DW / Z	130	DDF484RTE / RME / RFE / Z	46
4100KB	170	9404	191	CL102DW / Z	130	DDF485RFE / Z	46
4100NH	170	9553HBG	176	CL104DWYX / WY	130	DF001DW	100
4100NH2Z	170	9553HNG	176	CL105DW / WX	130	DF001GD201 NEW	26
4100NH3Z	170	9556HNG / HN / NB	177	CL106FDWYW / ZW	129	DF012DSE	99
4107R	170	9556HPG / PB	177	CL107FDWYW / ZW	129	DF0300 NEW	152
4112HS	169	9557HNG / NBG	179	CL108FDWYW / ZW	129	DF030DWE	97
4114S	169	9557HPG	179	CL111DWI / WR	130	DF031DSME / WAE / WYE / Z	88
4131	169	9558HNG / NBG	181	CL121DZ	129	DF032DSME / SAE / Z	87
4190DW	103	9558HPG	181	CL183DZX	131	DF033DSME / WAE / Z	87
4300BV	201	9563C	178	CP100DWA / Z	92	DF330DWE	97
		9565CR / PC	182	D		DF331DSME / Z	87
		9903	192	DA3010F	154	DF332DSME / SAE / Z	87
		9911	192	DA332DWAE / Z	91	DF333DSME / WAE / Z	87
		9924DB	192	DBO180Z	74	DFJ201ZM / ZL / ZXL	112
		A		DCB200B	113	DFJ202ZL / ZXL	111
		ADP05	107	DCF102Z	106	DFJ211ZM / ZL / ZXL	110
		ADP06	108	DCF201Z	106	DFJ212ZM / ZL / ZXL	111
		ADP08	108	DCF203Z	106	DFJ213ZM / ZL / ZXL	111
		AF353	207	DCG180RFE / RFEB / ZB / Z	86	DFJ214ZM / ZL / ZXL	110
		AF506	207	DCL180FRFW / RFB / ZB / Z	128	DFJ300ZXL	111
		AF601	207	DCL181FZWX	128	DFJ311ZM / ZL / ZXL	110
		AF635	207	DCL182FRFW / FZW	128	DFJ400ZXL	112

Double Insulation
Penebat Berganda | 双重绝缘

Variable Speed
Kelajuan Boleh Ubah | 无段变速

Brake
Brek | 电子自动刹车

Reversing
Mengundur | 正逆转

Electronic Ignition
Penyalan Elektronik | 电子式启动装置

Mechanical 2-Speed
2-kelajuan Mekanikal | 机械式双速

Electronic 2-Speed
2-kelajuan Elektronik | 电子式双速

Electronic 3-Speed
3-kelajuan Elektronik | 电子式三速

Electronic 4-Speed
4-kelajuan Elektronik | 电子式四速

Keyless Chuck
Chuck Pengetatan Diri | 自锁夹头

Torque Setting 6
Pelarasan Tork 6 | 6档扭力调整

Torque Setting 9
Pelarasan Tork 9 | 9档扭力调整

Torque Setting 16
Pelarasan Tork 16 | 16档扭力调整

Torque Setting 18
Pelarasan Tork 18 | 18档扭力调整

Torque Setting 20
Pelarasan Tork 20 | 20档扭力调整

DFJ411ZM / ZL / ZXL	110	DHS630RME / RFE / Z	75	DPO500Z	71	DUB182Z	85
DFN350Z	80	DHS661RFJ / Z	75	DPO600Z	71	DUB183Z	85
DFR550Z	55	DHS680RMJ / RFJ / Z	75	DPP200ZK / Z NEW	63	DUB184RT / Z NEW	85
DFS250RTE / RFE / Z	55	DHS710RM2J / RF2J	36	DPT353Z	80	DUB361Z	44
DFS251RTE / RFE / Z	55	DHS782Z	37	DRC200Z	124	DUB362RM2 / Z	44
DFS452Z	55	DHS783Z	37	DRS780Z	36	DUB363ZV NEW	44
DFV210ZM / ZL / ZXL	111	DHS900PT2 / Z NEW	37	DRT50Z / ZJX9	79	DUC122RME / Z	84
DGA402RFE / Z	68	DHW080ZK	45	DRV150Z	62	DUC252PM4 / Z	43
DGA404RTE / RFE / Z	68	DJN161Z	62	DRV250Z	62	DUC254Z	84
DGA405RFE / Z	68	DJR181RFE	76	DS4012	153	DUC353Z	43
DGA406RME / RFE / Z	67	DJR183Z	76	DS5000	153	DUC355Z	42
DGA408RME / RFE / Z	67	DJR186RME / RFE / Z	76	DSC102ZJ NEW	64	DUC356Z NEW	42
DGA411Z	67	DJR187RME / RFE / Z	76	DSC121ZK	64	DUC406Z	42
DGA414Z	67	DJR188Z	76	DSC162Z	64	DUH523RME / RFE / Z	81
DGA418Z	67	DJR360RF4 / Z	36	DSC163ZK	64	DUH601Z	81
DGA419Z NEW	66	DJS101Z	62	DSC191Z	65	DUH651Z	43
DGA452RME / RFE / Z	69	DJS130RFE / Z	62	DSC251ZK	65	DUH754SRT / Z NEW	81
DGA456RFE / Z	68	DJS161Z	62	DSD180Z	77	DUM168Z	84
DGA458RFE / Z	68	DJV180RFE / Z	77	DSL800Z	72	DUM604Z	84
DGA505RFE / Z	70	DJV181RFE / Z	77	DSP600Z	35	DUN500WZ NEW	82
DGA508RFE / Z	70	DJV182RME / RFE / Z	77	DSP601Z	35	DUN600LZ NEW	82
DGA511Z	70	DKP180RFE / Z	78	DSS501Z	75	DUP361Z	39
DGA514Z	70	DKP181RTJ / Z NEW	78	DSS610Z	75	DUP362ZN	39
DGA518Z	70	DLM380Z	41	DST221Z	80	DUR181Z	84
DGA519Z NEW	69	DLM382PT2 / Z NEW	41	DTD149RFE / Z	53	DUR182LRF / Z	83
DGA700Z	34	DLM431PT2 / Z	41	DTD152RME / RFE / Z	53	DUR184LZ	83
DGA701Z	34	DLM432PT2 / Z NEW	41	DTD153RTE / RFE / Z	53	DUR187LRF / Z	83
DGA900Z	34	DLM460Z	41	DTD154RME / RFE / Z	53	DUR188LRF / Z	83
DGA901Z	34	DLM532Z NEW	40	DTD155RME / Z	54	DUR188URFE	83
DGD800Z	71	DLS111Z	35	DTD156SF / Z NEW	53	DUR189Z	82
DGD801Z	71	DLS211Z	35	DTD170RME / RFE / Z	52	DUR190LRT2 NEW	82
DHK180Z NEW	60	DLS600Z	74	DTD171RTJ / RFJ / Z	52	DUR364LPM4 / RM2 / Z	38
DHP453RME / RFE / SYE / Z	50	DLS713RME / Z	74	DTL061Z	54	DUR368APT2 / Z	39
DHP458RME / RFE / Z	49	DLS714PM2 / Z	35	DTL062Z	103	DUR368LPT2 / Z	39
DHP459Z	50	DLW140Z	36	DTL063Z	59	DUR369LZ NEW	38
DHP481RTE / RFE / Z	49	DML186	117	DTM50Z	73	DUT130RFE / Z	61
DHP482RME / RFE / RFX1 / Z	49	DML801	116	DTM51RFEX8 / Z	73	DUT131Z	61
DHP483RME / RFE / Z	50	DML802	116	DTP141RFE / Z	54	DUX60ZM3 / Z	43
DHP484RME / RFE / Z	49	DML805	117	DTR180ZJ	63	DVC150LZ	120
DHP485RFE / Z	49	DML808	115	DTS141RFE / Z	54	DVC151LZ	120
DHR165RME / RFE / Z	60	DML807 NEW	115	DTW152Z	103	DVC152LZ	120
DHR171RTE / RFE / Z	60	DML810 NEW	115	DTW180Z	58	DVC153LZ	120
DHR182ZWJ	59	DML812 NEW	116	DTW181RFE / Z	58	DVC154LZ / ZX	121
DHR202RME / RFE / Z	59	DMP180Z NEW	86	DTW190RME / RFE / Z	58	DVC155LZX3 NEW	121
DHR241RFE / Z	59	DMR114 NEW	105	DTW251RME / RFE / Z	58	DVC157LZX5 NEW	121
DHR242RTE / RME / RFE / Z	59	DMR203 NEW	105	DTW285RME / RFE / Z	57	DVC260Z / ZX	122
DHR263PM4 / RF4 / Z	33	DP2010	152	DTW450RME / RFE / Z	57	DVC261Z	122
DHR280PT2J / Z	32	DPB180Z	65	DTW800RMJ / RFJ / Z	57	DVC265ZX NEW	122
DHR282PT2J / Z	32	DPB182Z	65	DTW1001RTJ / RMJ / RFJ / Z	57	DVC350Z	128
DHR400ZKN	32	DPJ180Z	79	DTW1002RTJ / RMJ / RFJ / Z	57	DVC660Z NEW	123

 **Torque Setting 21**
Pelarasan Tork 21 | 21档扭力调整

 **SDS-PLUS Shank**
Batang SDS-PLUS | 四坑柄

 **SDS-MAX Shank**
Batang SDS-MAX | 五坑柄

 **17mm Hex Shank**
Batang Heksagon 17mm | 17mm六角柄

 **30mm Hex Shank**
Batang Heksagon 30mm | 30mm六角柄

 **21mm Hex Shank**
Batang Heksagon 21mm | 21mm六角柄

 **28.6mm Hex Shank**
Batang Heksagon 28.6mm | 28.6mm六角柄

 **Torque Limiter**
Pengehad Tork | 扭力限制器 (安全离合器)

 **Constant Speed**
Kelajuan Tetap | 电子定速

 **Soft Start**
Penghidupan Secara Perlahan | 缓速起动

















 **Bevel Cutting L45 R5**
Pemotongan Serong Kiri 45° Kanan 5° | 斜角切割(左45°/右5°)

 **Bevel Cutting 45 left**
Pemotongan Serong Kiri 45° | 斜角切割(左45°)

 **Bevel Cutting 45 LR**
Pemotongan Serong Kiri Kanan 45° | 斜角切割(左右各45°)

 **Orbital Cutting**
Pemotongan Orbit | 轨道切割

 **Makita Shank Jig Saw Blade**
Bilah Gergaji Ukir Makita | M型式锯片

DVC665Z 	123	FS2300	154	GB801	190	HR2470X5	160
DVC750LZ / ZX1	128	FS2500	154	GD0600	188	HR2611FT	160
DVC860LZ	121	FS2700	155	GD0601	188	HR2630X3	160
DVC862LPT2 / RT2 / Z	122	FS4200	155	GD0603	189	HR2631FTX2	160
DVC863LPT2 / RT2 / Z	122	FS6300	155	GD0800C	189	HR2652	161
DVC864LZ	121	G		GD0801C	189	HR2810	161
DVF154Z	86	GA003GM201 / D201 	29	GD0811C	189	HR3200C	161
DVP180Z	79	GA005GM201 / D201 	30	GS5000	189	HR3210C	161
DVR450Z	86	GA011GM201 / D201 	29	GS6000	190	HR3530	162
DWT310ZK	33	GA013GM201 / D201 	30	GV5010	187	HR4001C	162
E		GA021GM201 / D201 / Z 	29	GV6010	187	HR4002	162
EA3110T30B	216	GA023GM201 / D201 / Z 	30	GV7000C	187	HR4003C	162
EA3201S40B	214	GA027GM201 / D201 / Z 	30	H		HR4013C	162
EA3502S40B	214	GA029GM201 / D201 / Z 	30	HB500	157	HR4030C	163
EA4301F45B	214	GA4030	177	HG5030K	209	HR4501C	163
EA5600F53G	216	GA4030R	176	HG6031VK	209	HR4511C	163
EA6100P	215	GA4031	177	HG6530VK	208	HR5202C	163
EA7900P70E	215	GA4034	177	HG6531CK	209	HR5211C	163
EB5300TH	219	GA4040	178	HK1820	166	HR5212C	164
EB7660TH	218	GA4040C	178	HM0810TA	164	HS004GM201 / Z 	31
EBH340R	212	GA4041C	178	HM0870C	164	HS0600	199
EBH340U	211	GA4530	179	HM0871C	164	HS100	210
EE2650H	212	GA4530R	179	HM1201	165	HS300DW	98
EH5000W	217	GA4540	180	HM1203C	165	HS301DSME / WAE / Z	93
EH6000W	217	GA4540R	179	HM1213C	165	HS6100	197
EH7500SX	217	GA4541C	180	HM1214C	165	HS6600	198
EK6101	221	GA5010	181	HM1306	165	HS7010	198
EK7301	221	GA5020	181	HM1307C	166	HS7600	198
EK7651H / X1	221	GA5030	180	HM1317C	166	HTR5600	218
ELM3311X	220	GA5030R	180	HM1810	166	HTR7610	218
ELM3320	220	GA5034	181	HM1812	166	HW102	223
ELM3711X	220	GA5040	182	HP001GD201 	26	HW121	223
ELM3720	220	GA5041C	182	HP0300 	158	HW1200	223
ELM4121	220	GA6010	182	HP1230	158	HW1300	223
EM2600U	212	GA6020C	183	HP1630	158	J	
EM2654LH	211	GA6040	183	HP2050	159	JN1601	174
EM3400L	212	GA7020	184	HP330DWE	97	JN3201	174
EM3400U	211	GA7040R	185	HP331DSME / WAE / WYE	88	JR001GM201 / Z 	31
EM4350RH	212	GA7050	183	HP332DSME / SAE / Z	88	JR100DWE	99
EN4951SH	218	GA7060	184	HP333DSME / WAE / Z	88	JR102DWE	99
ETR2500	213	GA7060R	184	HR001GM201 	28	JR105DWAE / Z	94
EW2051H	223	GA7061R	184	HR002GM201 	28	JR3050T	201
EW3051H	223	GA7062	184	HR003GM201 / Z 	28	JR3051TK 	201
EX2650LHM	213	GA7063R	183	HR140DWYE1	91	JR3070CT	202
EY2650H25H	217	GA9020	186	HR166DSMJ / WAJ / Z	91	JS1300	175
F		GA9050	185	HR1830	159	JS1601	175
FJ203DZL / DZLL	111	GA9060	186	HR1840	159	JS1602	175
FJ301DZM / DZL / DZLL	111	GA9060R	185	HR1841F	159	JS3201	175
FJ401DZL / DZLL / DZ3L	112	GA9061R	185	HR2020	159	JV0600K	200
FJ502DZM / ZL / ZLL	110	GB602	190	HR2320T / X2	160	JV100DWE	98

 **Bayonet Shank Jig Saw Blade**
Bilah Gergaji Ukir Jenis Bayonet | B型曲线锯锯片

 **Anti Vibration**
Anti Getaran | 防震

 **Capacitor Discharge Ignition**
Pencucuhan Nyahas Kapasitor | 电容放电式点火

 **Laser Marker**
Penanda Laser | 雷射标志

 **Automatic Oiling**
Fungsi Pelinciran Automatik | 自动润滑功能

 **Decompression Valve**
Injap Penyahmampatan | 减压阀

 **Hook & Loop**
Strap Velcro | 魔术贴式





 **Chain Brake**
Brek Rantai | 链条刹车

 **Auto Decompression**
Penyahmampatan Automatik | 自动减压

 **Depth Adjustment**
Pelarasan Kedalaman | 深度调整

 **Primer Pump**
Pam Utama | 按压吸油

 **Rapid Start**
Penghidupan Cepat | 快速启动

JV101DWAE / WYE / Z	93	RP0900	205	UH201DWAX / Z	95	M0400G	231
JV102DZ	94	RP1801	206	UH353DWA	95	M0600G	225
JV103DSMJ / WAJ / Z	93	RP2301FC	205	UH7580X	217	M0801G	226
K		RT0700C / X2	205	UM600DWA / Z	95	M0900G	227
KP0800X	203	S		UR100DSME / Z	95	M0910G	227
KP0810	203	SA5040C	186	UR201CZ 	38	M1100G	232
L		SC103DZJ 	92	UT1305	156	M1901G	232
LB1200F	202	SD100DWAJ / Z	93	UT2204	156	M1902G	232
LC1230	171	SG1251J	169	V		M2300G	230
LD030P	209	SJ401	202	VC1310LX1	139	M2400G	231
LD050P	210	SK104Z	209	VC2211M	138	M2401G	232
LD080P / PI	210	SK105DZ	96	VC2510L	139	M3600G	232
LF1000	197	SK105GDZ	96	VC3210L	139	M3601G	232
LH1201FL	196	SK106DZ	96	VC3211M	138	M3700G	233
LS0714	196	SK106GDZ	96	W		M3701G	233
LS1018L	195	SK209GDZ	96	WR100DWA / Z	90	M4000G	233
LS1019L	195	SK312GDZ	96			M4001G	233
LS1040	195	SP6000J	199			M4100G	231
LS1219L	195	ST113DWAJ / Z	94			M4301G	231
LS1440	196	T				M4302G	230
LW1400	173	TD001GD201 / Z 	27			M4501G	231
LW1401	173	TD0100	154			M5801G	230
M		TD0101F	154			M6001G	225
ML103	118	TD020DSW	99			M6200G	225
ML104 	117	TD022DSE	99			M6501G	225
ML105	117	TD090DWE	97			M6600XG	225
ML106	117	TD091DWE	98			M8100G	226
MLT100	197	TD110DSME / WAE / WYE / Z	89			M8103G	226
MP100DZ	95	TD111DSME / WAE / WYE / Z	88			M8600G	227
N		TL064DSME / WAE / Z	91			M8700G	226
N1900B	203	TL065DSME / WAE / Z	91			M8701X3G	226
N5900B	199	TM30DWAE / WAEX1 / Z	92			M9000G	229
P		TM3000C	190			M9001G	229
PC5000C	191	TM3010CX6	190			M9002G	228
PC5001C	191	TW001GM201 	27			M9200G	230
PC5010C	191	TW0200	157			M9201G	230
PJ7000	204	TW0350	157			M9202G	229
PK5001C	186	TW060DZ	90			M9204G	229
PLM4620N2	221	TW100DWE	98			M9400G	229
PLM5120	221	TW140DZ	89			M9503G	228
PLM5120N2	221	TW141DSME / WAE / Z	89			M9504G	228
PM7650H	219	TW160DZ	89			M9506G	227
PO5000C	188	TW161DSME / WAE / Z	89			M9508G	228
PO6000C	188	TW1000	156			M9509G	227
PT354DZ	94	U				M9511G	228
PTR2500	218	UB1103	210			M9512G	227
PV7000C	188	UC3541A	214			M9513G	227
PW5001C	191	UC3551A	213			M9800G	233
R		UC4041A	214				
RBC411U	211	UC4051A	213				

 **Stainless Tank**
Tangki Tahan Karat | 不锈钢箱体

 **Revolving Hose**
Hos Pusingan | 旋转软管

 **Static Free Hose**
Hos Bebas Statik | 防静电胶管

 **Dust Collecting**
Pengumpulan Habuk | 吸尘器连接

 **Built-in Job Light**
Lampu Kerja Terbina | 内置工作灯

 **Wooden Carrying Case**
Kotak Peralatan Kayu | 木制携带箱

 **Carrying Case**
Kotak Peralatan | 携带箱

 **Sequential or Bump-fire**
Sentakan Tunggal atau Berangkai | 连发模式

 **Auto Firing Stop**
Nyalaan Terhenti Secara Auto | 自动停止发射



XGT is a new system with its own tools, batteries, and chargers. A combination of innovative tool design and higher output batteries provide a genuine solution for high demand industrial users.

XGT adalah sistem baru dengan alat, baterai dan pengecas yang unik. Kombinasi reka bentuk alat inovatif dengan baterai output tinggi memberikan penyelesaian bagi pengguna industri permintaan tinggi. 采用全新的XGT智能充电供电系统，具有独特的工具、电池和充电器。创新的工具设计和高输出的电池相结合，为高需求的工业用户提供了真正的解决方案。

Optimum power supply system and Optimum charging system

The XGT range of tools and batteries come with a built-in program, providing digital communication between the battery and tool. Allowing not only for the battery to talk with tool but also the tool to talk to the battery. Battery technology and motor engineering that work together for optimum performance.

Sistem Bekalan Kuasa dan Pengecasan Pintar XGT
Bateri alat kuasa siri XGT mempunyai program terpasang untuk mewujudkan komunikasi dua hala antara bateri dan alat kuasa. Prestasi yang optimum dicapai dengan komunikasi antara teknologi bateri dan kejuruteraan motor yang berfungsi bersama
XGT智能充电供电系统
XGT系列产品工具的电池都有一个内置程序，实现电池与工具之间双向的通信，使电池和电机达到理想的性能。

Built Tough

High durability specifications specially designed for 40Vmax Li-ion batteries
Spesifikasi ketahanan tinggi direka khas untuk bateri Li-ion 40Vmax
专为 40Vmax 锂电池设计的高耐用性结构



4-LED fuel gauge indicator

Penunjuk tahap bateri
电池电量计指示灯



Heavy duty outer casing and cell holder

Bekas lindung dan alas bateri yang kukuh 坚固的外壳和电池架
Create a space to absorb impact
Ruang tambahan untuk menyerap hentaman
创造额外吸收冲击力的空间

Shock absorption structure

Struktur penyerapan kejutan
减震结构

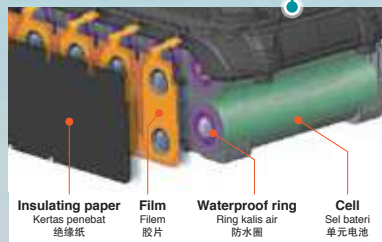

Waterproof Triple-layer Structure

prevents cell failure due to water and dust
Struktur kalis air tiga lapisan
Mencegah kerosakan bateri akibat air dan habuk
三层防水结构
防止因水和灰尘引起的电池故障

Tool ↔ Battery ↔ Battery Charger Digital communication

Alat Kuasa ↔ Bateri ↔ Pengecas Bateri | 工具 ↔ 电池 ↔ 充电器
Komunikasi digital | 数码通讯



Optimum charging system

Auto maintenance system with two cooling fans for providing more optimum fast charging
Sistem pengecasan pintar
Pengecas mempunyai sistem penyelenggaraan automatik dan mempunyai dua kipas penyejuk
智能充电系统
充电器具有自动维护系统，并且拥有两个冷却风扇



Terminal short-circuit prevention structure

The protection wall is provided between terminals against water and dust
Struktur pencegahan litar pintas terminal
Terdapat dinding pelindung kalis air dan tahan debu di antara terminal
端子防短路结构
端子之间设有防水防尘保护墙



High Rigidity Battery Rails

Durable slide in battery rail that holds the battery and the tools firmly and securely to withstand high power products
Slaid bateri berkekuatan tinggi
Slaid tahan lama di rel bateri untuk pegangan bateri dan alat kuasa dengan kukuh, sesuai untuk kerja yang berbeban tinggi
高强度电池滑轨
耐用的滑动式滑轨，可牢固地连接电池和工具，更适合高负荷的工作

OPTIMUM CHARGING SYSTEM

Sistem Pengisian Terbaik 智能充电系统



• It is necessary to cool down before start charging when the battery temperature is high
Bateri yang baru diguna bersuhu tinggi, ia perlu didinginkan sebelum pengisian bermula
刚使用完的电池处于高温状态, 要冷却后才能开始充电

• Built-in fan circulates air through the battery before start charging and during the charging process to cool the battery for faster charge time
Kipas akan terus menyejukkan bateri semasa pengisian untuk mencapai pengisian cepat
开始充电后, 风扇会持续冷却电池, 令充电时间更短

FAST CHARGING
Pengisian Cepat 快速充电

22 MINUTES
to fully charge a 3.0Ah slide Li-ion battery

*Charge time may vary depending on battery model or conditions of use
Masa pengisian mungkin berbeza bergantung kepada model bateri atau syarat penggunaan
充电时间可能因电池型号或使用条件而异

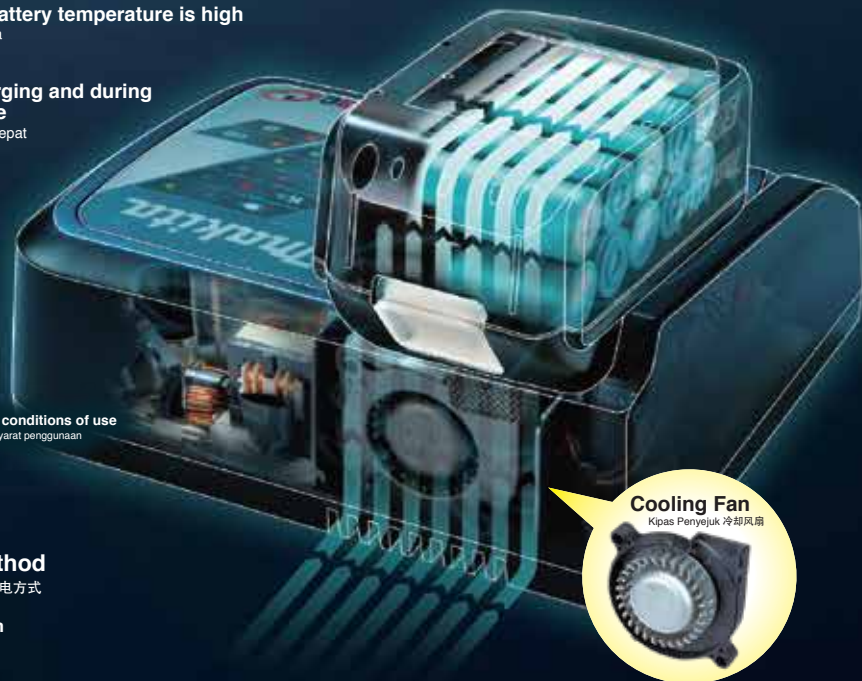

Makita
Optimum charging system
Sistem Pengisian Terbaik 智能充电系统

Forced air cooling



Fast charging



Optimum charging system

Sistem Pengisian Terbaik 智能充电系统

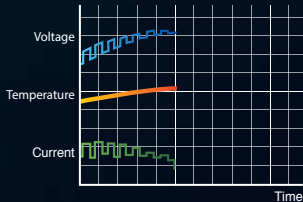

Competitor
General charging method
Kaedah Pengisian Umum 一般充电方式

Natural heat dissipation



Waiting time for charging



General charging method

Kaedah Pengisian Umum 一般充电方式

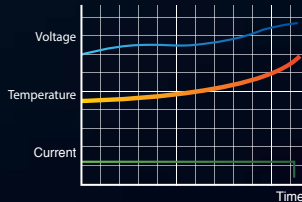

The Makita Rapid Optimum Charger communicates with the battery's built-in chip throughout the charging process to optimize battery life by actively controlling current, voltage and temperature

Makita Pengisian berkomunikasi dengan setiap sel unit dan mengawal arus, voltan dan suhu, membolehkan pengisian pantas dan memanjangkan hayat bateri

Makita充电器与每个单元电池进行通信并控制电流, 电压和温度, 实现了快速充电, 且延长电池使用寿命

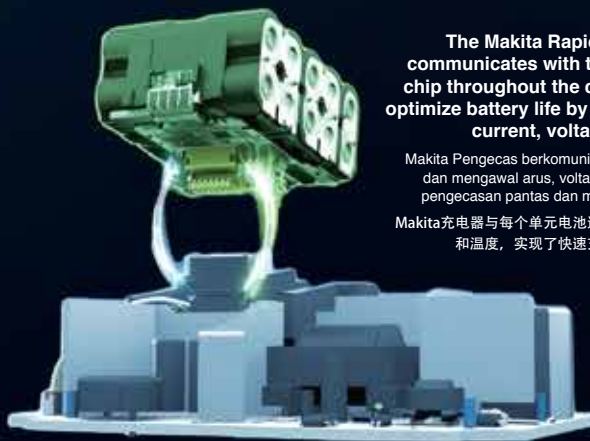

BATTERY PROTECTION FUNCTION

Fungsi Perlindungan Bateri 电池保护功能

Shock Absorbing

Tahan getaran 坚固防震

Heavy Duty Pack

Pembungkusan tugas berat

重型包装

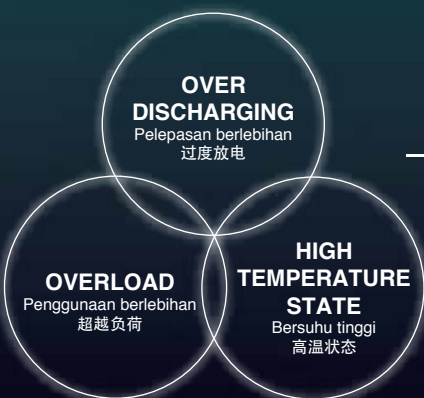

Built-In-CPU

CPU dibina dalam 内置CPU

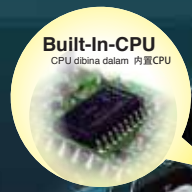

Anytime Charge

Caj pada bila-bila masa 随时充电

- No Memory Effect
Tiada Kesan Memori 不受记忆影响
- No Discharging Required
Tiada pelepasan diperlukan 不需要放电



Teknologi Ekstrim Litium-ion
锂离子技术



12Vmax LITHIUM-ION
12V Lithium-ion
12V 锂离子

CXT
Teknologi Ekstrim Kompak
紧凑极限技术

OPTIMUM CHARGING SYSTEM

Sistem Pengisian Terbaik 智能充电系统

FAST CHARGING
Pengecasan Cepat 快速充电
22 MINUTES
to fully charge a 1.5Ah slide Li-ion battery



* Charge time may vary depending on battery model or conditions of use
Masa pengecasan mungkin berbeza bergantung kepada model bateri atau syarat penggunaan
充电时间可能因电池型号或使用条件而异



Cooling Fan
Kipas Penyejuk 冷却风扇

LI-ION BATTERY

Sistem bateri Li-ion 锂电池系统

Multi-Contact Slide-type Terminal

Terminal slaid dengan pelbagai sambungan
多触点滑动式终端

- Ensures stable contact with tool even under extreme vibration
- Allows tools to be equipped with an ergonomic handle design
- Memastikan sambungan yang stabil dengan alat walaupun di bawah getaran yang melampau
- Membolehkan alat dilengkapi dengan reka bentuk pemegang ergonomik
- 即使在极端的振动下也能确保与工具的稳定连接
- 允许工具配备符合人体工程学的手柄设计



Battery fuel gauge

Penunjuk Tahap Bateri 电量显示

The power remaining in the battery can be indicated in 4 stages simply by pushing a button

Menekan butang untuk penunjuk tahap bateri
只需按一下按钮，电池中剩余的电量就可以分四个阶段显示出来



Charging status indicator

Penunjuk Status Mengecap 充电状态显示灯



shows the charging status of a battery being charged in 2 stages: less than 80% and 80% or more.



BATTERY & CHARGER TIME REFERENCE, COMPATIBILITY CHART

Panduan tempoh pengecasan dan bateri 电池充电时间参考表, 兼容性图表

	<p>4.0Ah BL4040 (191B26-6)</p>	<p>2.5Ah BL4025 (191B36-3)</p>
	<p>Fast Charger DC40RA Pengecas Pantas 快速充电器</p>	<p>45 min. Fast Charging</p>

	<p>Fast Charger DC40RA Pengecas Pantas 快速充电器</p>	<p>Two Port Multi Rapid Charger DC18RD (196934-4) Pengecas Pantas Dua Port 两端快速充电器</p>	<p>Standard Charger DC18SD (194534-4) Pengecas Standard 标准充电器</p>			
	<p>Adapter ADP10</p>	<p>Rapid Charger DC18RC (195586-8) Pengecas Pantas 快速充电器</p>	<p>Dual Port Fast Charger DC18RE (198446-3) Pengecas Pantas Dua Port 两端快速充电器</p>	<p>Four Port Multi Charger DC18SF (196427-1) Pengecas Biasa Empat Port 四端多功能充电器</p>	<p>Automotive Charger DC18SE (194618-8) Pengecas Automotif 汽车充电器</p>	
	<p>6.0Ah BL1860B (197422-4)</p>	<p>40 min.</p>	<p>55 min. Fast Charging</p>	<p>130 min. 1 to 2 Batteries</p>	<p>260 min. 3 to 4 Batteries</p>	<p>130 min.</p>
	<p>5.0Ah BL1850B (197282-4)</p>	<p>40 min.</p>	<p>45 min. Fast Charging</p>	<p>110 min. 1 to 2 Batteries</p>	<p>220 min. 3 to 4 Batteries</p>	<p>110 min.</p>
	<p>4.0Ah BL1840B (197265-4) (197267-0)</p>	<p>29 min.</p>	<p>36 min. Fast Charging</p>	<p>90 min. 1 to 2 Batteries</p>	<p>180 min. 3 to 4 Batteries</p>	<p>90 min.</p>
	<p>3.0Ah BL1830B (197600-6)</p>	<p>22 min.</p>	<p>22 min. Fast Charging</p>	<p>60 min. 1 to 2 Batteries</p>	<p>120 min. 3 to 4 Batteries</p>	<p>60 min.</p>
	<p>2.0Ah BL1820B (197256-5)</p>	<p>24 min.</p>	<p>24 min. Fast Charging</p>	<p>45 min. 1 to 2 Batteries</p>	<p>90 min. 3 to 4 Batteries</p>	<p>45 min.</p>
	<p>1.5Ah BL1815N (196235-0) (196449-1)</p>	<p>15 min.</p>	<p>15 min. Fast Charging</p>	<p>30 min. 1 to 2 Batteries</p>	<p>60 min. 3 to 4 Batteries</p>	<p>30 min.</p>
<p>1.3Ah BL1815 (194513-2)</p>	<p>15 min.</p>	<p>15 min. Fast Charging</p>	<p>30 min. 1 to 2 Batteries</p>	<p>60 min. 3 to 4 Batteries</p>	<p>30 min.</p>	

	<p>Speed Charger DC10SB (197346-4) Pengecas Pantas 快速充电器</p>	<p>Dual Port Fast Charger DC18RE (198446-3) Pengecas Pantas Dua Port 两端快速充电器</p>	<p>Standard Charger DC10WD (197450-9) Pengecas Standard 标准充电器</p>			<p>Standard Charger DC10WA (194589-9) Pengecas Standard 标准充电器</p>	
	<p>4.0Ah BL1041B (197406-2)</p>	<p>60 min. Fast Charging</p>	<p>130 min.</p>	<p>1.3Ah BL1013 (194550-8)</p>	<p>1.0Ah BL7010 (194355-4)</p>	<p>50 min. BL1013</p>	<p>30 min. BL7010</p>
	<p>2.0Ah BL1021B (197396-9)</p>	<p>30 min. Fast Charging</p>	<p>70 min.</p>	<p>18V G-Battery</p>		<p>Standard Charger DC18WA (195424-4) Pengecas Standard 标准充电器</p>	
	<p>1.5Ah BL1016 (197393-5)</p>	<p>22 min. Fast Charging</p>	<p>50 min.</p>	<p>1.5Ah BL1815G (198186-3)</p>	<p>70 min.</p>		

<p>14.4V Ni-MH</p>	<p>12V Ni-MH</p>	<p>9.6V Ni-MH</p>	<p>Standard Charger DC18SD (194534-4)</p>	<p>Automotive Charger DC18SE (194618-8) (194621-9)</p>	<p>12V Ni-CD</p>	<p>9.6V Ni-CD</p>	<p>Standard Charger DC1414 (193865-8)</p>			
<p>3.1Ah BH1433 (193354-3)</p>	<p>3.1Ah BH1233C (193930-3)</p>	<p>3.1Ah BH9033C (193591-9)</p>	<p>70 min.</p>	<p>70 min.</p>	<p>1.9Ah 1222 (192597-4)</p>	<p>—</p>	<p>45 min.</p>			
<p>1.8Ah BH1420 (193351-9)</p>	<p>1.8Ah BH1220C (193928-0)</p>	<p>1.8Ah BH9020A (193590-1)</p>	<p>40 min.</p>	<p>40 min.</p>	<p>1.3Ah PA12 (193981-6)</p>	<p>1.3Ah 1220 (192681-5)</p>	<p>1.3Ah PA09 (193977-7)</p>	<p>1.3Ah 9120 (192638-6)</p>	<p>1.3Ah 9100 (192019-4)</p>	<p>30 min.</p>
<p>14.4V Ni-MH</p>	<p>12V Ni-MH</p>	<p>9.6V Ni-MH</p>	<p>Standard Charger DC1414 (193865-8)</p>	<p>70 min.</p>	<p>9.6V Ni-CD</p>	<p>7.2V Ni-CD</p>	<p>Standard Charger DC1414 (193865-8)</p>			
<p>2.8Ah 1435 (193060-0)</p>	<p>2.8Ah 1235 (193059-5)</p>	<p>2.8Ah 9135 (193058-7)</p>	<p>70 min.</p>	<p>1.3Ah 9000 (191681-2)</p>	<p>1.3Ah 7000 (191679-9)</p>	<p>30 min.</p>				

BATTERY INFORMATION

Maklumat Bateri 关于电池的资讯

How to Keep Your Batteries at Their Best

Cara menggunakan prestasi bateri yang terbaik 如何使用才能发挥电池的最佳效能

Note the precautions below for keeping your batteries (Ni-Cd, Ni-MH, Li-ion) at their best to obtain maximum potential cycle life of batteries.

Perhatikan langkah penjagaan bateri berikut untuk memastikan bateri anda (Ni-Cd, Ni-MH, Li-ion) berada pada tahap terbaik untuk jangka hayat bateri berpotensi maksimum. 关于电池（镍镉、镍氢、锂电池）的最佳使用方法请参照下面的注意项目。电池将可得到最大的使用寿命。

1. No over-discharge

Stop using a tool and charge the battery when the tool power goes down or its motor speed slows down. Do not use a cordless tool when its power goes down. Otherwise, it will cause an imbalance of battery cells and reduction of battery cycle life.

Elakkan pelepasan berlebihan. Jika alat kuasa anda daya lemah (pengurangan kelajuan putaran motor) semasa penggunaan, berhenti menggunakannya dengan segera dan mengecas bateri (bateri dapat diisi semasa suhu turun ke suhu bilik). Dilarang terus menggunakan alat kuasa apabila kekuatannya semakin lemah kerana ketidakseimbangan sel bateri akan mengurangkan jangka hayat bateri.

避免过度放电在使用工具中如果感觉到力道减弱(马达的回转速降低)时,须马上停止使用且稍后(电池温度降至室温即可充电)进行充电。严禁工具的力道减弱时还继续的使用。会因为元件容量的不均而导致电池寿命的短缺。

2. No quick discharge

Avoid overloading during tool operation that causes quick discharge.

Elakkan beban berlebihan semasa operasi alat kuasa yang akan menyebabkan pelepasan cepat.

避免急速放电使用时请注意避免有过负载现象发生。

3. No over-charge

Recharging a fully charged battery is called "Over-charge". This will cause reduction of battery cycle life.

Elakkan pengecasan berlebihan. Mengecas semula bateri yang dicas penuh disebut "Over-charge". Ini akan mengurangkan jangka hayat bateri.

避免过度充电。充电后满电状态又再次作充电动作。这称为[过充电]。是导致电池寿命降低的原因。

If a fully charged battery is about to be charged, Makita automatic maintenance function will stop recharging immediately to prevent battery deterioration.

Sekiranya bateri yang penuh dicas semula, fungsi penyelenggaraan automatik akan diaktifkan untuk menghentikan tindakan pengecasan untuk mengelakkan kerosakan bateri. 牧田滑动式电池对于充满电后又再次作充电动作,自动保养机能会启动,将充电动作停止,防止电池的劣化产生。

4. Charge your batteries at an ambient temperature from 10°C to 40°C

Do not charge batteries cold from storage at a low ambient temperature below 10°C, or they are damaged. Also batteries are damaged at a high ambient temperature above 40°C, as the deterioration of battery cell materials are hastened by such a high temperature. Therefore, optimum air temperature for charging of batteries is from 10°C to 40°C. When you recharge a battery hot from operation of tool, do not leave it in the tool, but set it on the Makita charger for slide style batteries that will cool down the hot battery fast and efficiently with its forced air cooling system before recharging. This unique system will surely protect batteries from deterioration from heat.

Mengecas bateri yang disimpan pada suhu persekitaran antara 10 °C hingga 40 °C. Pengecasan bateri yang disimpan pada suhu persekitaran rendah (di bawah 10 °C) akan menyebabkan kerosakan bateri. Pengecasan bateri yang disimpan pada suhu persekitaran tinggi (melebihi 40 °C), kemerosotan bahan dalaman bateri akan dipercepat dan menyebabkan kerosakan bateri. Keluarkan bateri yang panas dari alat kuasa selepas penggunaan dan letakkan bateri pada pengecas. Pengecas Makita akan menyejukkan bateri panas dengan cepat dan cekap dengan sistem penyejukan sebelum mengecas semula. Sistem yang unik ini melindungi bateri daripada kerosakan akibat panas.

在10°C以下的低温环境中保管的电池如果进行充电,将对电池的本身造成伤害。另外,在40°C以上的高温环境下,会加速电池内部材料的劣化,也会对电池的本身造成伤害。在10°C~40°C的温度内充电是最合适的。刚使用完且还有些发热的状态的电池,不要插在电动工具上。需移至充电器。充电器的冷却装置会很效率的将电池散热后再进行充电,如此,可以防止发热导致电池劣化的情形发生。

5. Keep your batteries away from moisture

High humidity and extreme temperature swings cause dew drop, and it will cause rust and short-circuit.

Elakkan bateri dari wap air. Kelembapan tinggi dan perubahan suhu yang melampau akan menyebabkan karat dan litar pintas.

不要触碰水气。生锈是短路的原因,高温,极端的温度差会导致结露现象产生。

6. Do not exert any significant impact on batteries

String impact on battery will cause internal wire breakage or cracks on battery housing.

Elakkan hentakan ketara yang akan menyebabkan kerosakan wayar dalaman atau keretakan pada penutup bateri.

不要强烈撞击,外壳的破损,是内部断线的原因。

Charge the battery when the motor speed slows down!
Mengecas bateri apabila kelajuan motor alat kuasa menjadi perlahan
转速降低时,立即停止使用,准备充电!



Battery Care & Storage

Penjagaan & simpanan bateri 电池的保管方法

Store batteries at an ambient temperature below 35°C. Avoid storing batteries at a high air temperature and humidity

Simpan bateri pada suhu persekitaran di bawah 35°C, elakkan menyimpan bateri pada suhu dan kelembapan udara yang tinggi 将电池存放在低于35°C的环境温度下,避免将电池存放在空气温度高和湿度高的地方

Storage in fully charged condition

Jenis bateri yang mesti disimpan dalam keadaan terisi penuh
须在充满电状态下保管的电池种类



Li-ion Battery
Bateri Li-ion 锂电池



Ni-MH Battery
Bateri Ni-MH 镍氢电池

Storage in fully discharged condition

Jenis bateri yang mesti disimpan dalam keadaan havis
须在放电状态下保管的电池种类



Ni-CD Battery
Bateri Ni-CD 镍镉电池

※ Ni-MH batteries have to be charged once a year due to its self-discharging nature. Bateri Ni-MH harus dicas setahun sekali kerana ciri pelepasan diri. 由于镍氢电池自放电特性,建议每年充电一次。

※ Ni-CD batteries have to be fully discharged before storage. After storage for sometimes, ensure Ni-CD batteries are fully charged before use. Bateri Ni-CD mesti dilepaskan sepenuhnya sebelum disimpan. Setelah disimpan untuk jangka waktu tertentu, pastikan bateri Ni-CD dicas penuh sebelum digunakan. 镍镉电池必须在存放前完全放电。存放一段时间后,请确保镍镉电池在使用前已充满电。

CORDLESS ADVANTAGE

Tanpa Kord 充电式优势



Easy to Use

Mudah digunakan 方便使用

Start-up

Alat enjin 引擎工具

Engine tools

Peralatan enjin 引擎工具



Engine tools need time and tips to start-up
Peralatan enjin memerlukan masa untuk dihidupkan
引擎工具需要时间和技巧来启动

Cordless tools

Peralatan tanpa kord 充电式工具



Cordless tools start just after inserting battery and switching on
Peralatan tanpa kord mudah dihidupkan dengan pemasangan bateri sahaja
安装电池后并开启充电式工具便可开始工作

Constant speed control

Kelajuan tetap 电子恒速控制

Engine tools

Peralatan enjin 引擎工具



Engine tools are hard to keep the constant rotation speed under load
Peralatan enjin sukar untuk mengekalkan kelajuan putaran berterusan
引擎工具很难在负载下保持恒定的转速

Cordless tools

Peralatan tanpa kord 充电式工具



Cordless tools keep rotation speed under load with "Constant speed control" function
Peralatan tanpa kord berfungsi "kawalan kelajuan putaran berterusan"
充电式工具保持旋转"恒定负载下的速度"控制功能

Low noise (Noise level comparison)

Bunyi rendah 低噪声

Engine tools

Peralatan enjin 引擎工具



Cordless tools

Peralatan tanpa kord 充电式工具



Clean & Easy Maintenance

Bersih dan mudah dijaga 清洁和容易保养



Zero emission

Tanpa pelepasan asap 无排气

Engine tools

Peralatan enjin 引擎工具



Cordless tools

Peralatan tanpa kord 充电式工具



Cordless tools don't generate any exhaust gas
Peralatan tanpa kord tidak mengeluarkan gas ekzos
充电式工具不会产生废气

Cost and time reduction

Kurangkan kos dan masa 减少成本和時間

Engine tools

Peralatan enjin 引擎工具



It takes time to prepare mixed fuel for engine
Mengambil masa untuk menyediakan bahan api campuran
untuk Enjin 需时为发动机准备混合燃料

Cordless tools

Peralatan tanpa kord 充电式工具



Just insert battery and ready to use
Pasangkan bateri dan sedia untuk digunakan
只需安装电池即可使用

Easy maintenance

Penyelenggaraan mudah 易于维护

Engine tools

Peralatan enjin 引擎工具

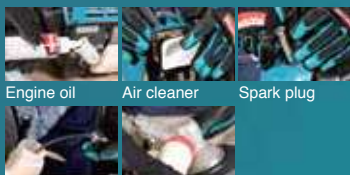

Cordless tools

Peralatan tanpa kord 充电式工具



Cordless tools are maintenance - Free unlike engine tools
Peralatan tanpa kord bebas dari penyelenggaraan
充电式工具免维护

Long term storage

Penyimpanan jangka panjang 长期存放

Engine tools

Peralatan enjin 引擎工具



If you store the tool for a long period, when the fuel remained in the tank It may be a cause of trouble or defect
Peralatan enjin mungkin akan rosak sekiranya disimpan lama dengan bahan api dalam tangki
燃油长时间留在油箱可能会造成工具故障

Cordless tools

Peralatan tanpa kord 充电式工具



Even if you store the tools for a long period, Just insert battery and ready to use
Walaupun menyimpan peralatan dalam jangka masa yang panjang, ia sedia digunakan dengan pemasangan bateri
充电式工具即使长时间存放, 只需安装电池即可使用

Purpose-built Brushless Motors

Motor tanpa berus 无碳刷马达

Makita-built Brushless Motor eliminates carbon brushes, enabling the motor to run cooler and more efficiently for longer life. The electronically controlled Brushless Motor efficiently uses energy to match torque and RPM to the changing demands of the application

Motor tanpa berus yang dibuat oleh Makita menghapuskan berus karbon, membolehkan motor berjalan lebih sejuk, lebih cekap dan lebih tahan lama. Motor tanpa berus yang dikawal secara elektronik dengan cekap menggunakan tenaga untuk menyesuaikan tork dan RPM kepada perubahan permintaan aplikasi. Makita制造的无碳刷马达消除了碳刷, 使马达更冷却的运作, 更有效, 更长使用寿命。电子控制的无碳刷马达有效地利用能量将扭力及RPM以配合不断变化的需求

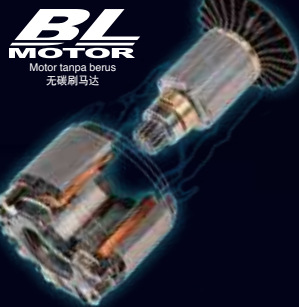

Enhanced dust and drip-resistant performance of the tools

Prestasi tahan debu dan tahan titisan air
提高工具的防尘与防水滴性能, 令工具更耐用

XPT
EXTREME PROTECTION TECHNOLOGY
Teknologi Perlindungan Ekstrem
防尘防水滴技术



Image is for advertising effects only
Image hanya untuk kesan iklan 图片仅为广告特效

AWS

Auto - start Wireless System
Sistem permulaan wayarles automatik
无线自动启动系统



Connects to Compatible Vacuum Cleaners with Bluetooth

Sambungan tanpa wayar dengan pembersih vakum yang serasi dengan Bluetooth 通过蓝牙连接到兼容的吸尘器



WUT01 wireless unit
Enables wireless connection of Makita AWS™ capable tools with AWS™ Vacuum Cleaners



Part No.199393-1

Untuk sambungan tanpa wayar alat kuasa AWS™ Makita dengan pembersih vakum AWS™

Makita AWS™ 工具与AWS™ 吸尘器无线连接

WUT02 wireless unit adapter
Enables wireless connection of Makita AWS™ capable tools with most AC vacuum cleaner with auto start/ stop functions



Part No.199809-6

Sambungan tanpa wayar alat kuasa AWS™ Makita dengan pembersih vakum AC yang berfungsi permulaan/ berhenti automatik

无线连接具有Makita AWS™ 功能的电动工具与具有自动启动/停止功能的AC吸尘器

DGA701 | DGA901



DHR400



DHR282



DGA414 | DGA418



DSP601



DVC864L



DVC154L



DVC265



DLS111 | DLS211



DSL800



Switch on the tool and the vacuum cleaner will start automatically

Hidupkan alat kuasa dan pembersih vakum akan bermula secara automatik
启动电动工具，吸尘器将自动启动

AVT

ANTI VIBRATION TECHNOLOGY

Teknologi Anti Getaran
防振技术



- Vibration absorbing housing
- Active dynamic vibration absorber
- Damper spring

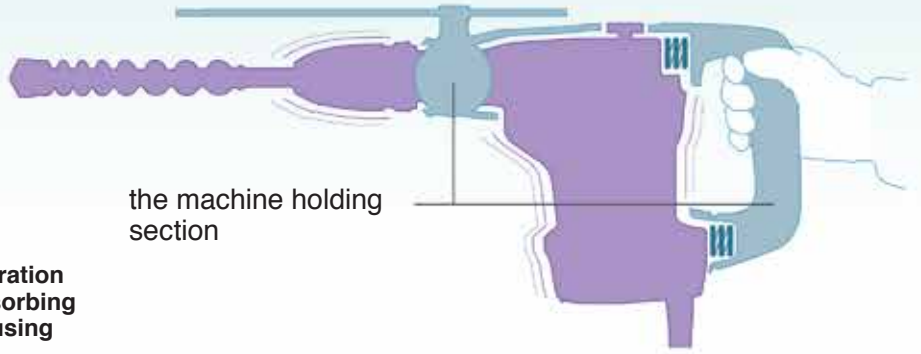

the machine holding section

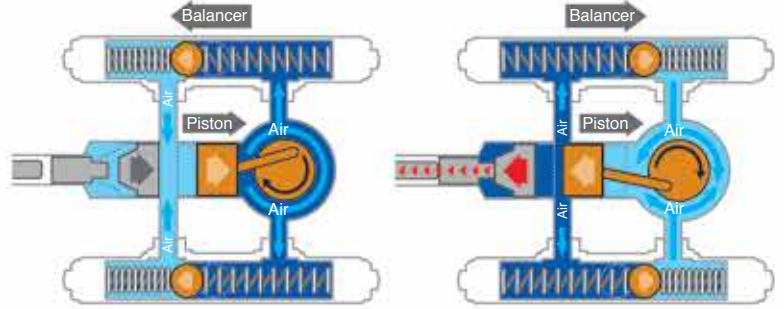

SOFT NO LOAD

Getaran rendah tanpa beban
无负载时低振动

During no-load



Suppression of motor speed

Penindasan kelajuan motor 电机转速的抑制

- reduces vibration of tool body when idling, accordingly decreases the amount of vibration to operator's hands during a day's operation
mengurangkan getaran badan alat ketika melahu, dengan itu mengurangkan jumlah getaran ke tangan pengendali semasa operasi sehari 减少空转时工具主体的振动, 从而减少一天操作中操作者手部的振动量
- minimizes deflection of bit tip from aiming point when starting chipping
meminimumkan pesongan bit tip dari titik sasaran apabila memulakan kerepotan 开始切屑时, 将刀尖从瞄准点的偏移减至最小

During no-load

Under load

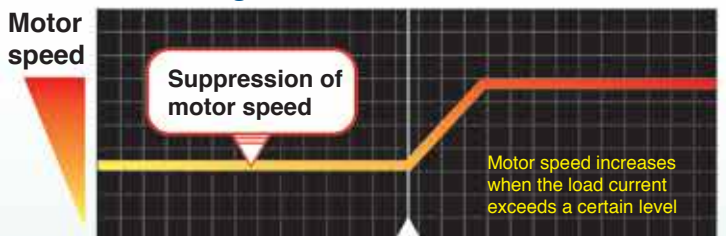

when starting chipping

Equipped with automatic speed control

Dilengkapi dengan kawalan laju automatik 设置自动速度控制功能



Automatically changes the cutting speed according to load conditions for an optimum operation
Fungsi pertukaran kelajuan automatik 自动变速功能

- On light duty: high-speed rotation mode
- On heavy duty: high torque mode
- Pada tugas ringan: mod putaran berkelajuan tinggi
- Pada tugas berat: mod torq tinggi
- 轻载: 高速旋转模式
- 重载: 高扭矩模式

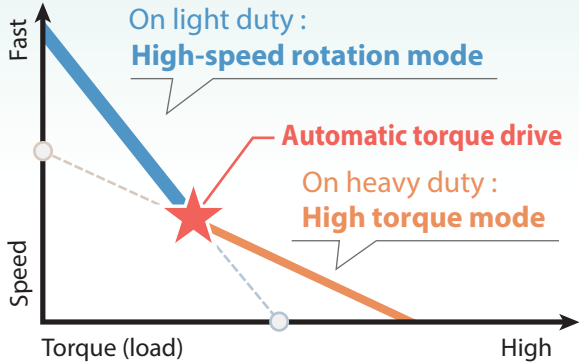

Smart function to minimize the danger of kick-back

Fungsi pintar untuk mengurangkan risiko kick-back 智慧型功能可减少反冲之危



Shuts down the tool to protect the user, if the rotation speed suddenly slows down

Jika kelajuan putaran tiba-tiba dikurangkan, alat akan dimatikan secara automatik untuk melindungi pengguna

若旋转速度突然降低, 工具将自动关闭以保护使用者

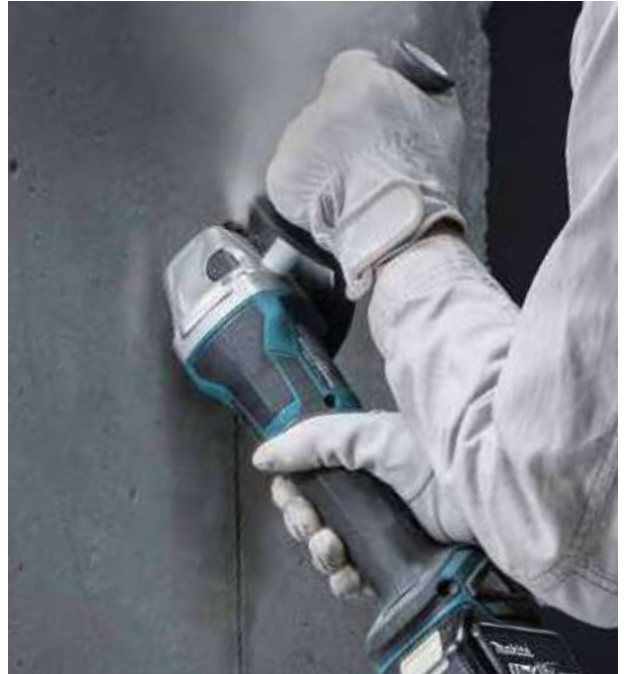
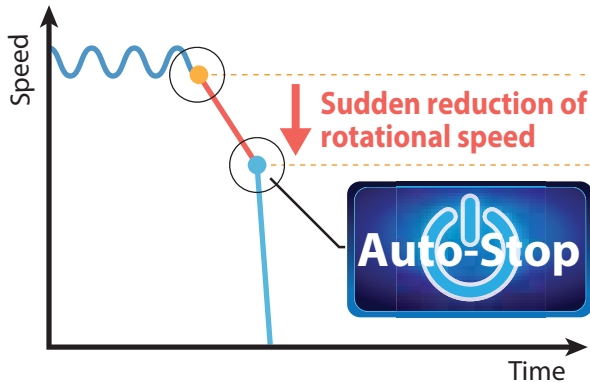

Electric Brake System
Sistem Brek Elektrik 电子自动刹车系统

Electric brake

Brek elektrik 电子自动刹车

Electric brake is activated after the tool is switched off

Brek elektrik diaktifkan selepas alat dimatikan
电子自动刹车在工具关闭后被启动

Large switch lever

Tuas suis yang besar 大开关杆

with lock-off function (without lock-on function)

Lock-off function prevents the switch lever from being accidentally pulled
dengan fungsi mengunci
menghalang tuas suis daripada ditarik secara tidak sengaja
锁定功能可防止开关杆被意外拉动

Anti-restart function

Fungsi anti-restart 防止意外重启功能

The motor does not start up if battery is inserted when the switch slid to "on".

Selepas memuatkan bateri, motor tidak bermula jika suis ditetapkan ke kedudukan "ON"
装入电池后, 若开关设于「开启」位置时, 马达不会启动

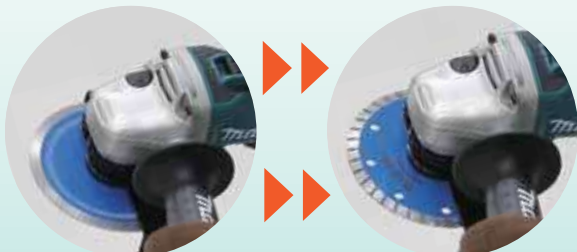

Electric brake is activated after the tool is switched off
Brek elektrik diaktifkan selepas alat dimatikan
电子自动刹车在工具关闭后被启动

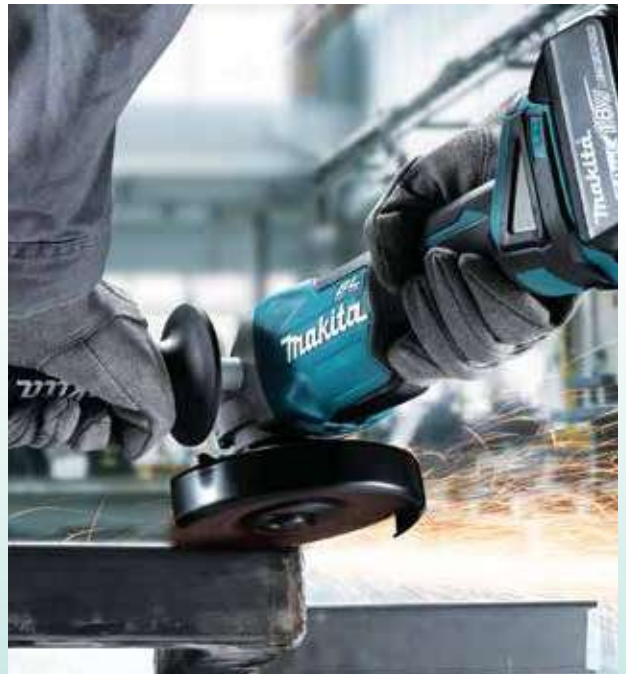



TO SUPPRESS VIBRATION TO OPERATOR

Menahan Getaran 在操作时能抑止震动

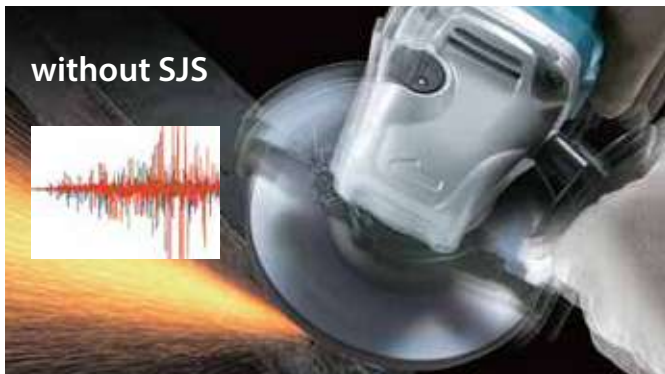

Structure of Super Joint System II

Struktur SJS generasi kedua 第二代 SJS 的结构

Leaf spring absorbs vibration and relieves shock during operation.

Leaf spring menyerap getaran dan mengurangkan kesan hentaman semasa operasi 在运行过程中，弹簧片吸收振动并减轻冲击



Absorption mechanism of vibration

Mekanisme penyerapan getaran 振动的吸收机能

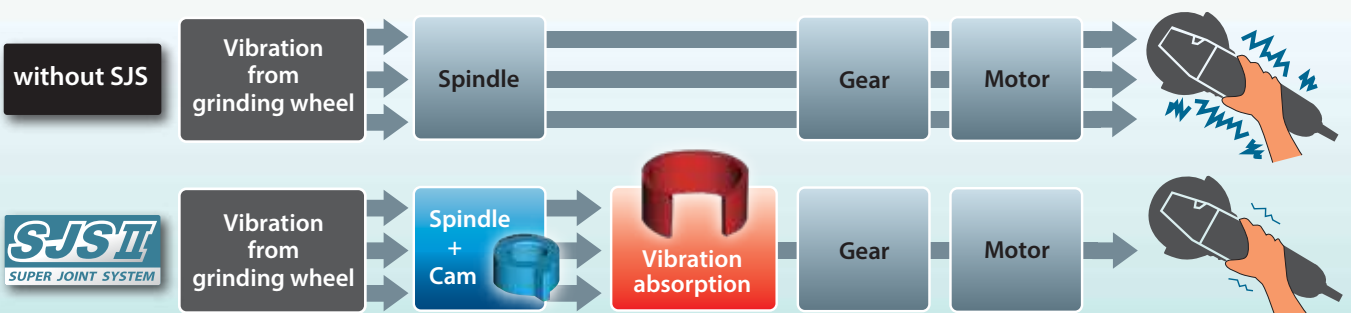

Automatic Self-cleaning Filtration System achieved by two filter units

Sistem Penapis Penyucian Automatik 自动清洗过滤系统

Constantly high suction power throughout operation because dust is removed from Prefilters every 10 seconds during operation

Kuasa penyedut yang berterusan sepanjang operasi kerana habuk dikeluarkan dari penapis setiap 10 saat semasa operasi

在整个运行过程中吸力保持在较高的水平，因为在运行过程中，每10秒就会从过滤器中除去灰尘



Automatic self-cleaning filter (VC1310L, VC2510L, VC3210L)

Sistem Penapis Penyucian Automatik 自动清洗过滤系统

obtained by Triple filter structure composed of: Powder filter + Damper + Prefilter

Kuasa penyedutan yang berterusan sepanjang operasi kerana habuk dikeluarkan dari Prefilters setiap 10 saat semasa operasi

由三重过滤器结构得到：粉末过滤器+阻尼器+预过滤器



When the power is switched on, Prefilter collapses into itself, to compress Damper, and fits closely over Damper and Powder filter.

Apabila kuasa dihidupkan, Prefilter runtuh ke dalamnya untuk memampatkan Damper, dan sesuai dengan penapis Damper dan Serbuk.
当接通电源时，Prefilter会自行折叠以压缩阻尼器，并紧密贴合阻尼器和粉末过滤器。

When the power is switched off, Damper expands back to its original size and shakes off dust from Prefilter automatically with its expanding power.

Apabila kuasa dimatikan, Damper mengembang kembali ke saiz asalnya dan menggelakkan habuk dari Prefilter secara automatik dengan kuasa yang berkembang.
当电源关闭时，阻尼器膨胀回到其原始尺寸，并通过扩展的功率自动将Prefilter的灰尘抖落。



DEEP CUTTING

Pemotongan dalam 深层切割

DXT

Deep and Exact Cutting Technology

Teknologi Pemotongan Ketepatan Dalam
深层精准切割技术

3-Stage reduction gear unit and Movable rear blade guard provide larger capacities of cutting Crown molding and Baseboard (Skirt board)

Peranti gear pengurangan tiga peringkat dan tutup belakang bilah gergaji boleh alih untuk pemotongan mudah diagonal garisan siling dan garis sudut (panel dinding) 三级减速齿轮装置及活动的后锯片护罩，方便斜切天花板线和墙角线(护壁板)

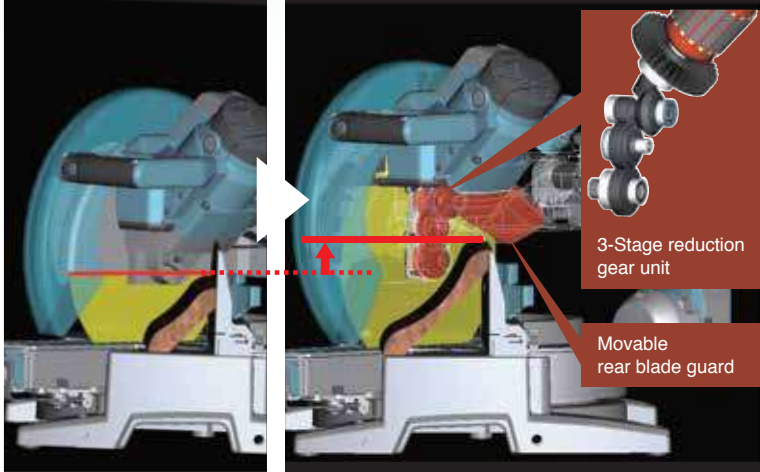

Capable of diagonal cutting up to **203mm (8")** crown molding

Capable of vertical cutting up to **165mm (6-1/2")** baseboard (skirt board)



EXACT CUTTING

Pemotongan ketepatan 精准切割

Double sliding mechanism

Teknologi pemotongan ketepatan dalam 双重滑动结构

Makita advantages obtained by using 4 short steel poles instead of 2 long poles are;

- Vibration-free, precise and exact cutting
- Compact tool design for jobsite portability

Gantikan 4 paip keluli panjang dengan 4 paip keluli pendek, supaya produk Makita mempunyai kelebihan berikut

- Bebas getaran, pemotongan tepat
- Reka bentuk alat padat untuk kemudahan medan

以4支短钢管取代2支长钢管，令牧田产品有以下优势之处

- 无振动，精确切割
- 紧凑的工具设计可实现现场便携性

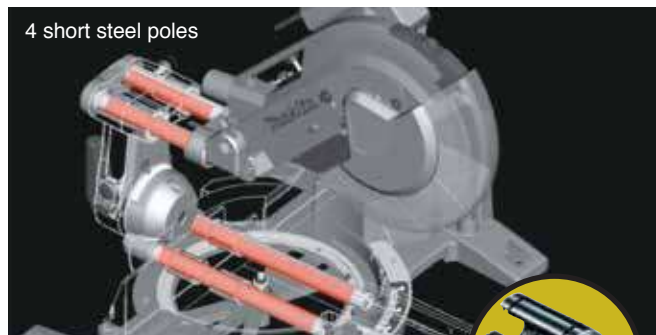

4 short steel poles

6 linear ball bearings are used to support the 4 poles for smooth and precise sliding cut.



Double sliding guide fence

Teknologi pemotongan ketepatan dalam 双重滑动引导栅

The upper and the lower sections slide independently for added convenience; each upper fence slides outwards for bevel cut, and each lower fence slide inwards to securely hold small workpiece for precise and exact cutting

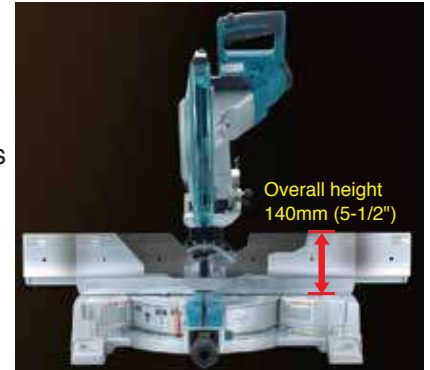

Bahagian atas dan bawah meluncur secara berasingan untuk kemudahan tambahan, grid panduan atas boleh meluncur ke luar pada sudut serong untuk dipotong, dan grid panduan bawah dapat meluncur ke dalam untuk memegang bahan-bahan kecil untuk memotong tepat

上下部分独立滑动以增加便利；上部引导栅能向外滑动斜角切割，而下部引导栅能向内滑动以牢牢地固定小材料，以进行精确的切割



Quick and accurate miter angle lock

Kunci sudut miter yang cepat dan tepat
快速准确的斜接角度锁定

- Miter angle can be locked/unlocked simply by turning the knob 90 degrees.
- With positive stops at 0, 15, 22.5, 31.6, 45 degrees



DLS111



DLS211



DLS600



LS1019L



LS1219L

MAKPAC POWER SOURCE KIT

Set Bateri MAKPAC | MAKPAC锂电池套装

XGT 40V Li-ion max



1x Fast Charger DC40RA (191E08-6)
Pengecas Pantas 快速充电器

2x 4.0Ah Battery BL4040 (191B26-6)
Bateri 锂电池

BASIC 40Vmax 4.0Ah
(191J70-1)

XGT 40V Li-ion max



1x Makpac Connector Box Type 1 (821549-5)
Kotak Sambungan Makpac 工具连接箱

2x 2.5Ah Battery BL4025 (191B36-3)
Bateri 锂电池

POWER 40Vmax 2.5Ah
MKP1G001 (191J86-6)

XGT 40V Li-ion max



1x Makpac Connector Box Type 1 (821549-5)
Kotak Sambungan Makpac 工具连接箱

2x 4.0Ah Battery BL4040 (191B26-6)
Bateri 锂电池

ADVANCED 40Vmax 4.0Ah
MKP1G002 (191K02-4)

18V LITHIUM-ION
18V Lithium-ion
18V 锂离子



1x Makpac Connector Box Type 1 (821549-5)
Kotak Sambungan Makpac 工具连接箱

2x 1x Rapid Charger DC18RC (195586-8)
Pengecas Pantas 快速充电器

3x 1x 3.0Ah Battery BL1830B (197600-6)
Bateri 锂电池

BASIC 18V 3.0Ah
MKP1RF181 (197973-7)

18V LITHIUM-ION
18V Lithium-ion
18V 锂离子



1x Makpac Connector Box Type 1 (821549-5)
Kotak Sambungan Makpac 工具连接箱

2x 1x Rapid Charger DC18RC (195586-8)
Pengecas Pantas 快速充电器

3x 2x 3.0Ah Battery BL1830B (197600-6)
Bateri 锂电池

POWER 18V 3.0Ah
MKP1RF182 (197974-5)

18V LITHIUM-ION
18V Lithium-ion
18V 锂离子



1x Makpac Connector Box Type 1 (821549-5)
Kotak Sambungan Makpac 工具连接箱

2x 1x Rapid Charger DC18RC (195586-8)
Pengecas Pantas 快速充电器

3x 2x 4.0Ah Battery BL1840B (197265-4)
Bateri 锂电池

POWER 18V 4.0Ah
MKP1RM182 (191L71-1)

18V LITHIUM-ION
18V Lithium-ion
18V 锂离子



1x Makpac Connector Box Type 1 (821549-5)
Kotak Sambungan Makpac 工具连接箱

2x 1x Rapid Charger DC18RC (195586-8)
Pengecas Pantas 快速充电器

3x 1x 5.0Ah Battery BL1850B (197282-4)
Bateri 锂电池

BASIC 18V 5.0Ah
MKP1RT181 (197801-6)

18V LITHIUM-ION
18V Lithium-ion
18V 锂离子



1x Makpac Connector Box Type 1 (821549-5)
Kotak Sambungan Makpac 工具连接箱

2x 1x Rapid Charger DC18RC (195586-8)
Pengecas Pantas 快速充电器

3x 2x 5.0Ah Battery BL1850B (197282-4)
Bateri 锂电池

POWER 18V 5.0Ah
MKP1RT182 (197803-2)

18V LITHIUM-ION
18V Lithium-ion
18V 锂离子



1x Makpac Connector Box Type 3 (821551-9)
Kotak Sambungan Makpac 工具连接箱

2x 1x Two Port Multi Rapid Charger DC18RD (196934-4)
Pengecas Pantas Dua Port 两端快速充电器

3x 2x 5.0Ah Battery BL1850B (197282-4)
Bateri 锂电池

ADVANCED 18V 5.0Ah
MKP3PT182 (198182-1)

18V LITHIUM-ION
18V Lithium-ion
18V 锂离子



1x Makpac Connector Box Type 3 (821551-9)
Kotak Sambungan Makpac 工具连接箱

2x 1x Two Port Multi Rapid Charger DC18RD (196934-4)
Pengecas Pantas Dua Port 两端快速充电器

3x 4x 5.0Ah Battery BL1850B (197282-4)
Bateri 锂电池

ULTIMATE 18V 5.0Ah
MKP3PT184 (197627-6)

18V LITHIUM-ION
18V Lithium-ion
18V 锂离子



1x Makpac Connector Box Type 1 (821549-5)
Kotak Sambungan Makpac 工具连接箱

2x 1x Rapid Charger DC18RC (195586-8)
Pengecas Pantas 快速充电器

3x 2x 6.0Ah Battery BL1860B (197422-4)
Bateri 锂电池

ADVANCED 18V 6.0Ah
MKP1RG182 (198119-8)

18V LITHIUM-ION
18V Lithium-ion
18V 锂离子



1x Makpac Connector Box Type 3 (821551-9)
Kotak Sambungan Makpac 工具连接箱

2x 1x Two Port Multi Rapid Charger DC18RD (196934-4)
Pengecas Pantas Dua Port 两端快速充电器

3x 4x 6.0Ah Battery BL1860B (197422-4)
Bateri 锂电池

ULTIMATE 18V 6.0Ah
MKP3PG184 (198095-6)

12Vmax LITHIUM-ION
12V Lithium-ion
12V 锂离子



1x Makpac Connector Box Type 1 (821549-5)
Kotak Sambungan Makpac 工具连接箱

2x 1x Speed Charger DC10SB (197346-4)
Pengecas Pantas 快速充电器

3x 2x 1.5Ah Battery BL1016 (197393-5)
Bateri 锂电池

BASIC 12Vmax 1.5Ah
MKP1SY122 (197654-3)

12Vmax LITHIUM-ION
12V Lithium-ion
12V 锂离子



1x Makpac Connector Box Type 1 (821549-5)
Kotak Sambungan Makpac 工具连接箱

2x 1x Speed Charger DC10SB (197346-4)
Pengecas Pantas 快速充电器

3x 2x 2.0Ah Battery BL1021B (197396-9)
Bateri 锂电池

POWER 12Vmax 2.0Ah
MKP1SA122 (197664-0)

12Vmax LITHIUM-ION
12V Lithium-ion
12V 锂离子



1x Makpac Connector Box Type 1 (821549-5)
Kotak Sambungan Makpac 工具连接箱

2x 1x Speed Charger DC10SB (197346-4)
Pengecas Pantas 快速充电器

3x 2x 4.0Ah Battery BL1041B (197406-2)
Bateri 锂电池

ULTIMATE 12Vmax 4.0Ah
MKP1SM122 (197640-4)

Portable Power Pack

Bekalan kuasa mudah alih 便携式电源

PDC01



18V Lithium-ion X2
18V 锂离子电池



18V Lithium-ion
18V 锂离子



Teknologi Ekstrem Litium-ion
锂离子技术

Comfortable For Long Hours Operation

Selesa untuk operasi masa panjang 舒适的长时间操作

Battery cover
Protection from water and dust
Penutup bateri untuk perlindungan daripada air dan habuk
防水防尘电池盖

Comfortable, adjustable backpack harness
Harness ransel yang selesa dan boleh laras 舒适可调节的背带

Lightweight 7kg
with 4x 5.0Ah batteries
Reka bentuk ringan - hanya 7kg dengan bateri 4x 5.0Ah
轻巧的设计, 配备4个5.0Ah电池仅重7公斤

Cord length 1.7m
Panjang kord 1.7m 长1.7m

Fuel gauge for each battery indicates the battery status by two green lights
Penunjuk tahap bateri
menunjukkan status bateri dengan dua lampu hijau
每个电池的电量计, 通过两个绿色指示灯指示电池状态

Main power switch With auto-off function
Suis kuasa utama dengan fungsi auto-off
主电源开关具有自动关机功能



Continuous Usage Time (approx.)

Masa Penggunaan Berterusan 连续使用时间

High Speed: 2 hours 50 minutes

Low speed: 12 hours 10 minutes



Continuous Usage Time (approx.)

Masa Penggunaan Berterusan 连续使用时间

Dial 6: 24 minutes

Dial 1: 2 hours 48 minutes



Work Amount (approx.)

Jumlah Kerja 工作量

60 holes

Concrete compressive strength
Grade 40 ϕ 18mm depth 140mm

TWO VARIATIONS

(Without Battery) + 18Vx2 Adapter only Part No.191A67-6

(Without Battery) + 18V & 18Vx2 Adapter Part No.191A62-6

Recommended products

Produk yang disyorkan 推荐产品



Cordless Chain Saw



Cordless Blower



Cordless Grass Trimmer



Cordless Hedge Trimmer



Cordless Angle Grinder



Cordless Rotary Hammer
(except DHR282)

Convenience for every OCCASION

Sesuai Untuk Pelbagai Kegunaan/ 适用于任何场合

Heat-resistant Temperature
0 ~ 60°C
Suhu tahan haba 0 ~ 60°C
保冷度 0 ~ 60°C

Maintaining COOL Temperature
Mengekalkan suhu sejuk
冷藏专用

MAKPAC Cool Box

Kotak Sejuk MAKPAC/ 层叠式冷藏箱

20mm thickness formed polystyrene, sealing strips are placed around the mating surface of lid and box

Dibuat dari ketebalan 20mm polistirena dan dipasang dengan jalur pengedap di sekeliling permukaan penutup dan kotak
箱体壁厚为20mm, 盖子和箱子的连接处配备密封条



11L

500mL x 10 | 2L x 2

(Type 3)

Part No. 198254-2

- Dimensions
Dimensi | 体积 (L x W x H)
295 x 395 x 210mm (11-5/8" x 15-1/2" x 8-1/4")
- Net weight
Berat bersih | 净重
2.9kg (6.3lbs)



• Both type can be equipped with a shoulder strap

Kedua-dua jenis Makpac boleh dipasang dengan tali pemegang bahu
两种型号皆可配备肩带



Come with Shoulder belt
Dilengkapkan dengan tali pemegang bahu | 配备背负肩带



18L

500mL x 20 | 2L x 4

(Type 4)

Part No. 198253-4

- Dimensions
Dimensi | 体积 (L x W x H)
295 x 395 x 315mm (11-5/8" x 15-1/2" x 12-3/8")
- Net weight
Berat bersih | 净重
3.7kg (8.1lbs)



Type 1
Part No. 821549-5

Type 2
Part No. 821550-0

Type 3
Part No. 821551-8

Type 4
Part No. 821552-6

• MAKPAC Box
Kotak Makpac
工具连接箱



Part No. TR00000002
• Able to stack on MAKPAC trolley for easy loading (option)

Boleh ditambah dan disambung atas troli Makpac untuk memudahkan kerja pengalihan kotak Makpac (pilihan)
Makita工具箱可以添加并连接到拖运车, 以方便搬运(选择性)



18V
Lithium-ion

LXT

Teknologi Ekstrim Lithium-ion
锂离子技术

CORDLESS COMBO KIT

Pakej kombo peralatan tanpa kord 充电式工具套装

18V
LITHIUM-ION
18V Lithium-ion | 18V 锂离子

CORDLESS COMBO KIT
Pakej kombo peralatan tanpa kord 充电式工具套装

DLX2248PT1



BL
MOTOR

Motor tanpa berus 无碳刷马达

1 1x DVC260Z

Cordless Backpack Vacuum Cleaner
Pembersih Vakum Beg Galas Tanpa Kord
充电式背负吸尘器

2x 5.0Ah Battery (BL1850B)
Bateri 5.0Ah (BL1850B)
5.0Ah 电池 (BL1850B)

2 1x DCL181F Cordless Cleaner
Pembersih Vakum Tanpa Kord
充电式便携吸尘器

1x 5.0Ah Battery (BL1850B)
Bateri 5.0Ah (BL1850B)
5.0Ah 电池 (BL1850B)

3 1x Makita Tool Bag
Beg Alat Makita
Makita 工具袋

4 1x Two Port Multi
Rapid Charger (DC18RD)
Pengecas Pantas Dua Port (DC18RD)
两端快速充电器 (DC18RD)

1x Round Brush (198877-6)
Berus Bulat 圆刷

1x Flexible Rubber Nozzle (197900-4)
Muncung Getah Fleksibel 弹性吸嘴

1x Nozzle Assembly (198037-9)
Komponen Muncung 吸嘴组件

1x Corner Nozzle (198918-8)
Muncung Sudut 角落吸嘴

1x Flexible Hose (198867-9)
Hos Fleksibel 软管

10pcs Paper Dust Bag (197902-0)
Beg Habuk Kertas
纸制集尘袋

10pcs Filter (198914-6)
Penapis
尘袋

CORDLESS COMBO KIT

Pakej kombo peralatan tanpa kord 充电式工具套装

DLX3131TX2

18V
LITHIUM-ION
18V Litium-ion | 18V 锂离子

NEW
BARU 新

BL MOTOR
Motor tanpa berus 无碳刷马达
XPT
EXTREME PROTECTION TECHNOLOGY
Teknologi Perlindungan Ekstrem
防尘防水滴技术

- 1x DHR242 24mm (15/16")
Cordless Combination Hammer
Tukul Kombinasi Tanpa Kord 充电式冲击电钻电锤
1x 5.0Ah Battery (BL1850B)
Bateri 5.0Ah (BL1850B) 5.0Ah 电池 (BL1850B)

BL MOTOR
Motor tanpa berus 无碳刷马达
XPT
EXTREME PROTECTION TECHNOLOGY
Teknologi Perlindungan Ekstrem
防尘防水滴技术

- 2 1x DTW285 12.7mm (1/2")
Cordless Impact Wrench
Perengkuh Impak Tanpa Kord 充电式冲击套筒扳手
1x 5.0Ah Battery (BL1850B)
Bateri 5.0Ah (BL1850B) 5.0Ah 电池 (BL1850B)



- 3 1x DGA404 100mm (4")
Cordless Angle Grinder
Pengisar Sudut Tanpa Kord 角向磨光机
1x 5.0Ah Battery (BL1850B)
Bateri 5.0Ah (BL1850B) 5.0Ah 电池 (BL1850B)
1x Depressed Centre Wheel (A-80852)
Cakera Abrasive 磨片



- 4 1x Two Port Multi
Rapid Charger (DC18RD)
Pengecas Pantas Dua Port (DC18RD)
两端快速充电器 (DC18RD)



- 5 1x Makita Tool Bag
(831271-6)
Beg Alat Makita
Makita 工具袋

CORDLESS COMBO KIT

Pakej kombo peralatan tanpa kord 充电式工具套装

DLX2218X



- 1 1x Rapid Charger (DC18RC)
Pengecas Pantas (DC18RC)
快速充电器 (DC18RC)

18V
LITHIUM-ION
18V Litium-ion | 18V 锂离子



- 2 1x DHR165 16mm (5/8")
Cordless Rotary Hammer
Tukul Berputar Tanpa Kord 充电式电锤
1x 3.0Ah Battery (BL1830B)
Bateri 3.0Ah (BL1830B) 3.0Ah 电池 (BL1830B)

- 3 1x DTW190 12.7mm (1/2")
Cordless Impact Wrench
Perengkuh Impak Tanpa Kord
充电式冲击套筒扳手
1x 3.0Ah Battery (BL1830B)
Bateri 3.0Ah (BL1830B) 3.0Ah 电池 (BL1830B)



- 4 1x Makita Aluminium
Suitcase
Beg Bimbit Aluminium Makita
Makita 铝合金工具箱

CORDLESS COMBO KIT

Pakej kombo peralatan tanpa kord 充电式工具套装

DLX2220



- 1 1x Rapid Charger (DC18RC)
Pengecas Pantas (DC18RC)
快速充电器 (DC18RC)

18V
LITHIUM-ION
18V Litium-ion | 18V 锂离子

- 2 1x DTD155 Cordless
Impact Driver
Pemutar Skru Impak Tanpa Kord
充电式冲击螺丝起子机
1x 3.0Ah Battery (BL1830B)
Bateri 3.0Ah (BL1830B) 3.0Ah 电池 (BL1830B)



- 3 1x DDF483 13mm (1/2")
Cordless Driver Drill
Gerudi Pemutar Skru Tanpa Kord
充电式螺丝起子电钻
1x 3.0Ah Battery (BL1830B)
Bateri 3.0Ah (BL1830B) 3.0Ah 电池 (BL1830B)



- 4 1x Makita Tool Bag
Beg Alat Makita
Makita 工具袋

CORDLESS COMBO KIT
Pakej kombo peralatan tanpa kord 充电式工具套装

DK0090SWX1

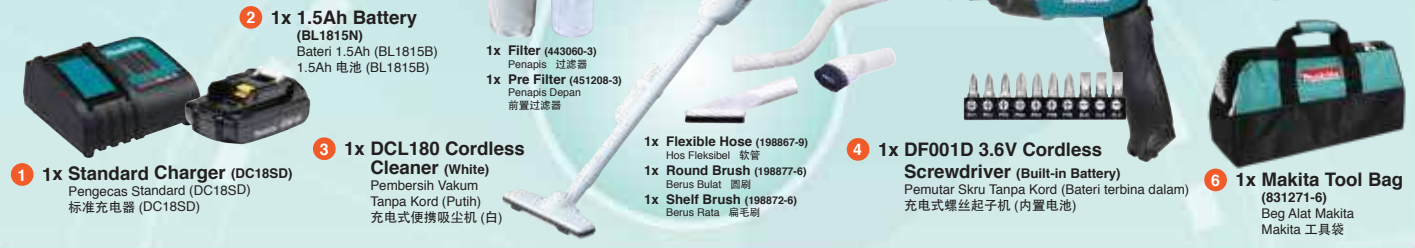

1 1x Standard Charger (DC18SD)
Pengecas Standard (DC18SD)
标准充电器 (DC18SD)

2 1x 1.5Ah Battery (BL1815N)
Bateri 1.5Ah (BL1815B)
1.5Ah 电池 (BL1815B)

3 1x DCL180 Cordless Cleaner (White)
Pembersih Vakum Tanpa Kord (Putih)
充电式便携吸尘器 (白)

4 1x DF001D 3.6V Cordless Screwdriver (Built-in Battery)
Pemutar Skru Tanpa Kord (Bateri terbina dalam)
充电式螺丝起子机 (内置电池)

5 1x ADP07 Adapter for USB
Pengecas
充电器

6 1x Makita Tool Bag (831271-6)
Beg Alat Makita
Makita 工具袋

18V LITHIUM-ION
18V Lithium-ion | 18V锂离子

1x Filter (443060-3)
Penapis 过滤器

1x Pre Filter (451208-3)
Penapis Depan
前置过滤器

1x Flexible Hose (198867-9)
Hos Fleksibel 软管

1x Round Brush (198877-6)
Berus Bulat 圆刷

1x Shelf Brush (198872-6)
Berus Rata 扁毛刷

CORDLESS COMBO KIT
Pakej kombo peralatan tanpa kord 充电式工具套装

DK0089WX1



1 1x Standard Charger (DC10WD)
Pengecas Standard (DC10WD)
标准充电器 (DC10WD)

2 1x 1.5Ah Battery (BL1016)
Bateri 1.5Ah (BL1016)
1.5Ah 电池 (BL1016)

3 1x CL107FD Cordless Cleaner (White)
Pembersih Vakum Tanpa Kord (Putih)
充电式便携吸尘器 (白)

4 1x DF001D 3.6V Cordless Screwdriver (Built-in Battery)
Pemutar Skru Tanpa Kord (Bateri terbina dalam)
充电式螺丝起子机 (内置电池)

5 1x ADP07 Adapter for USB
Pengecas
充电器

6 1x Makita Tool Bag (831271-6)
Beg Alat Makita
Makita 工具袋

12Vmax LITHIUM-ION
12V Lithium-ion | 12V锂离子

5pcs Paper Filter (194566-1)
Penapis Kartas
纸制尘袋

1x Flexible Hose (198867-9)
Hos Fleksibel 软管

1x Round Brush (198877-6)
Berus Bulat 圆刷

1x Shelf Brush (198872-6)
Berus Rata 扁毛刷

CORDLESS COMBO KIT
Pakej kombo peralatan tanpa kord 充电式工具套装

CLX224

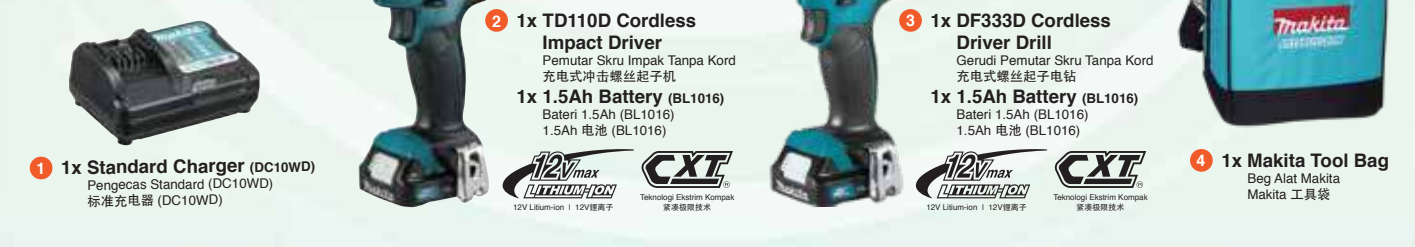

1 1x Standard Charger (DC10WD)
Pengecas Standard (DC10WD)
标准充电器 (DC10WD)

2 1x TD110D Cordless Impact Driver
Pemutar Skru Impak Tanpa Kord
充电式冲击螺丝起子机

3 1x DF333D Cordless Driver Drill
Gerudi Pemutar Skru Tanpa Kord
充电式螺丝起子电钻

4 1x Makita Tool Bag
Beg Alat Makita
Makita 工具袋

1.5Ah Battery (BL1016)
Bateri 1.5Ah (BL1016)
1.5Ah 电池 (BL1016)

12Vmax LITHIUM-ION
12V Lithium-ion | 12V锂离子

CXT
Teknologi Ekstrim Kompak
家康极限技术

CORDLESS COMBO KIT
Pakej kombo peralatan tanpa kord 充电式工具套装

CLX224X1

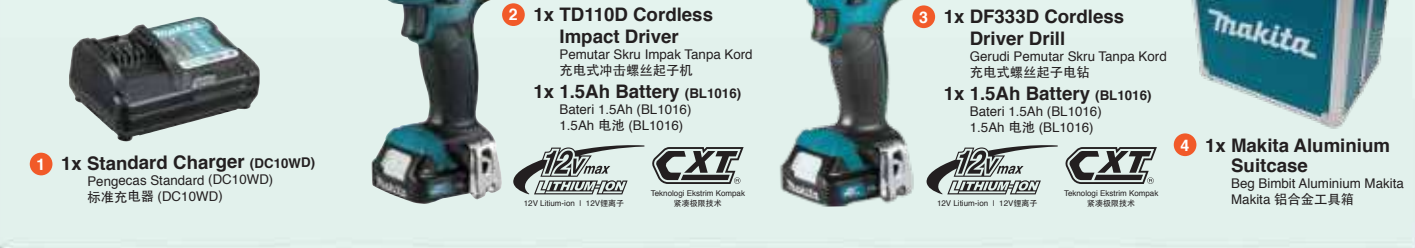

1 1x Standard Charger (DC10WD)
Pengecas Standard (DC10WD)
标准充电器 (DC10WD)

2 1x TD110D Cordless Impact Driver
Pemutar Skru Impak Tanpa Kord
充电式冲击螺丝起子机

3 1x DF333D Cordless Driver Drill
Gerudi Pemutar Skru Tanpa Kord
充电式螺丝起子电钻

4 1x Makita Aluminium Suitcase
Beg Bimbit Aluminium Makita
Makita 铝合金工具箱

1.5Ah Battery (BL1016)
Bateri 1.5Ah (BL1016)
1.5Ah 电池 (BL1016)

12Vmax LITHIUM-ION
12V Lithium-ion | 12V锂离子

CXT
Teknologi Ekstrim Kompak
家康极限技术

CORDLESS COMBO KIT
Pakej kombo peralatan tanpa kord 充电式工具套装

CLX206AX2



1 1x Standard Charger (DC10WD)
Pengecas Standard (DC10WD)
标准充电器 (DC10WD)

2 1x TM30D Cordless Multi Tool
Mesin Pemotong Pelbagai Guna Tanpa Kord
充电式多功能切割磨机

3 1x DF331D Cordless Driver Drill
Gerudi Pemutar Skru Tanpa Kord
充电式螺丝起子电钻

4 1x Makita Tool Bag (831253-8)
Beg Alat Makita
Makita 工具袋

2.0Ah Battery (BL1021B)
Bateri 2.0Ah (BL1021B)
2.0Ah 电池 (BL1021B)

1x Accessories Set
Set Aksesori 配件套装

1x Phillips Bit
Mata Skru 螺丝批头

12Vmax LITHIUM-ION
12V Lithium-ion | 12V锂离子

CXT
Teknologi Ekstrim Kompak
家康极限技术

XGT

40V Li-ion max

High Power

Kuasa Tinggi 高马力

Durability

Ketahanan 超耐用

Digital Communication

Sistem Pintar 智能系统



Battery

BL4025 (2.5Ah)

BL4040 (4.0Ah)

Charger

DC40RA

ADP10

Adapter for LXT Battery





DF001G



HP001G

Max Fastening Torque
Tenaga Pemutaran Pengancing Maksimum 最大紧固扭力
140 N·m



41 electronic clutch settings

A wider range of heavy-duty applications achieved by increasing clutch settings

41 tetapan clutch elektronik (21 tahap dalam mod tinggi) Merealisasikan rangkaian aplikasi tugas berat yang lebih luas dengan meningkatkan tetapan clutch
41级电子离合器设置
(高级模式下21级设置)通过增加离合器档位设置实现更广泛的重型应用

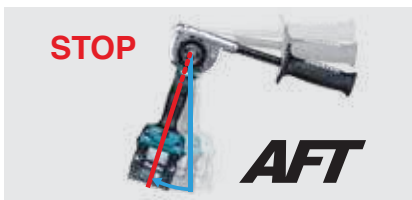

Active Feedback sensing Technology

Torque limiter turns the motor off if the tool is suddenly forced to lock

Teknologi Sensor Maklum Balas Automatik
Sekiranya alat ini terkunci secara tidak sengaja, pembatas tork secara automatik akan mematikan motor
AFT 主动反馈传感技术
如果工具被意外锁死, 扭矩限制器会自动关闭电机



Compact overall length -24mm

DF001GD201 13mm (1/2")
RM 5,047

Cordless Driver Drill
Gerudi Pemutar Skru Tanpa Kord
充电式螺丝起子电钻



DF001G



VIDEO CLIP
Models and specs may vary by country

• Excellent performance in continuous heavy duty applications

Standard Equipment: Side Grip, Belt Clip, (+/-) Bit, Bit Holder

• D201: 1x Fast Charger, 2x 2.5Ah Battery



Capacity Kapasiti 能力	Steel: 20mm (13/16") Wood (Auger-Bit): 50mm (2") Wood (Self-Feed Bit): 76mm (3") Wood (Hole Saw): 152mm (6") Siding Board: 220mm (8-5/8")
Chuck Capacity Kapasiti Chuck 夹头能力	1.5 - 13mm (1/16" - 1/2")
No Load Speed (RPM) Kelajuan Tanpa Beban 回转数	High: 0 - 2,600 Low: 0 - 650
Max Fastening Torque Tenaga Pemutaran Pengancing Maksimum 最大紧固扭力	Hard: 140N·m (1,240in.lbs.) Soft: 68N·m (600 in.lbs.)
Max Lock Torque Pemutaran Tenaga Maksimum 最大扭矩	125N·m (1,100in.lbs.)
Max Peak Torque Pemutaran Maksimum 最大值扭力	141N·m
Dimensions (L x W x H) Dimensi 体积	181x86x275mm (7-1/8"x3-3/8"x10-7/8")
Net Weight Berat Bersih 净重	2.7 - 3.0kg (5.9 - 6.6lbs.)

HP001GD201 13mm (1/2")
RM 5,100

Cordless Hammer Driver Drill
Tukul Pemutar Skru Bergerudi Tanpa Kord
充电式冲击螺丝起子电钻



HP001G



VIDEO CLIP
Models and specs may vary by country

• Excellent performance in continuous heavy duty applications

Standard Equipment: Depth Gauge, Side Grip, Belt Clip, (+/-) Bit, Bit Holder

• D201: 1x Fast Charger, 2x 2.5Ah Battery



Capacity Kapasiti 能力	Steel: 20mm (13/16") Wood (Auger-Bit): 50mm (2") Wood (Self-Feed Bit): 76mm (3") Wood (Hole Saw): 152mm (6") Siding Board: 220mm (8-5/8") Masonry: 20mm (13/16")
Chuck Capacity Kapasiti Chuck 夹头能力	1.5 - 13mm (1/16" - 1/2")
Impacts Per Minute (IPM) Impak Per Minit 冲击数	High: 0 - 39,000 Low: 0 - 9,750
No Load Speed (RPM) Kelajuan Tanpa Beban 回转数	High: 0 - 2,600 Low: 0 - 650
Max Fastening Torque Tenaga Pemutaran Pengancing Maksimum 最大紧固扭力	Hard: 140N·m (1,240in.lbs.) Soft: 68N·m (600 in.lbs.)
Max Lock Torque Pemutaran Tenaga Maksimum 最大扭矩	125N·m (1,100in.lbs.)
Max Peak Torque Pemutaran Maksimum 最大值扭力	141N·m
Dimensions (L x W x H) Dimensi 体积	182x86x275mm (7-1/8"x3-3/8"x10-7/8")
Net Weight Berat Bersih 净重	2.7 - 3.0kg (6.0 - 6.6lbs.)

* All list price shown are for reference only (exclude SST).

* Semua harga yang ditunjukkan adalah untuk rujukan sahaja (tidak termasuk SST). 所有显示的建议零售价仅供参考 (不包括SST)。





TD001G



TW001G

TD001G

10 Tightening modes
10 mod pengetatan 10种紧固模式
4-speed power selection
+
6-Assist modes

Drive $\phi 6.5 \times 120\text{mm}$ metal fastening screws

TD001G	115	2.5s
Predecessor Model 18V	100	

Low Fastening speed High

Max Fastening Torque
Tenaga Pemutaran Pengancing Maksimum 最大紧固扭力
220N·m

TW001G



Usability improvement
Impact power selection: 4 stages
Forward and Reverse Rotation auto stop
Forward: 3 mode / Reverse: 3 mode
4 tahap pilihan daya impact
Kelajuan dan daya hentakan yang sesuai dapat dipilih mengikut keperluan
4个等级冲击力选择
可根据实际工作的需要选择合适的速度和冲击力

TD001GD201 RM 4,525 | **TD001GZ** RM 1,717

Cordless Impact Driver
Pemutar Skru Impak Tanpa Kord
充电式冲击螺丝起子机



- 4-speed power selection plus 6 Assist modes (2 T-modes, 1 Wood mode, 3 Bolt modes)

Standard Equipment: Belt Clip

- D201: 1x Fast Charger, 2x 2.5Ah Battery
- Z: Without Charger, Battery & Carrying Case



TD001G

Models and specs may vary by country

Capacity Kapasiti 能力	Machine Screw: M4 - M8 (5/32" - 5/16") Standard Bolt: M5 - M16 (3/16" - 5/8") High Strength Bolt: M5 - M14 (3/16" - 9/16") Coarse thread (in length): 22 - 125 mm (7/8" - 4-7/8") 6.35 mm (1/4")
Hex Shank Batang Heksagon 六角柄	
No Load Speed (RPM) Kelajuan Tanpa Beban 回转数	Max / Hard / Med / Soft / Wood / Bolt (1) / Bolt (2) / Bolt (3) / T (1) / T (2) mode: 0 - 3,700 / 3,200 / 2,100 / 1,100 / 1,800 / 2,500 / 3,700 / 3,700 / 2,400 / 3,700
Impacts Per Minute (IPM) Impak Per Minit 冲击数	Max / Hard / Med / Soft / Wood / Bolt (1) / Bolt (2) / Bolt (3) / T (1) / T (2) mode: 0 - 4,400 / 3,600 / 2,600 / 1,100 / 4,400 / N/A / 4,400 / 4,400 / N/A / 2,600
Max Fastening Torque Tenaga Pemutaran Pengancing Maksimum 最大紧固扭力	220N·m (1,950in.lbs.)
Fastening Torque Tenaga Pemutaran Pengancing 扭力	Hard: 170N·m(1,510in.lbs.) Med: 50N·m(440in.lbs.) Soft: 20N·m (180in.lbs.)
Dimensions (L x W x H) Dimensi 体积	120x86x245mm (4-3/4"x3-3/8"x9-5/8")
Net Weight Berat Bersih 净重	1.7 - 2.0kg (3.7 - 4.4lbs.)

TW001GM201 19mm (3/4")
RM 6,568

Cordless Impact Wrench
Perengkuh Impak Tanpa Kord
充电式冲击套筒扳手



- Higher torque and more compact than DTW1001

Standard Equipment: Belt Clip

- M201: 1x Fast Charger, 2x 4.0Ah Battery



TW001G

Models and specs may vary by country

Fastening Capacities Kapasiti 能力	Standard Bolt: M12 - M36 (1/2" - 1-7/16") High Strength Bolt: M10 - M27 (3/8" - 1-1/16") 19 mm (3/4")
Square Drive Batang Segi Empat 四方柄	
No Load Speed (RPM) Kelajuan Tanpa Beban 回转数	Max: 0 - 1,800 Hard: 1,400 Mid: 1,150 Soft: 950
Impacts Per Minute (IPM) Impak Per Minit 冲击数	Max: 0 - 2,500 Hard: 2,400 Mid: 2,200 Soft: 1,900
Max Fastening Torque Tenaga Pemutaran Pengancing Maksimum 最大紧固扭力	1,800N·m (1,330ft.lbs.)
Nut-Busting Torque Tork Pengetatan Bolt 螺栓拧紧扭力	2,050N·m (1,510ft.lbs.)
Dimensions (L x W x H) Dimensi 体积	217x94x297mm (8-1/2"x3-11/16"x11-3/4")
Net Weight Berat Bersih 净重	3.9 - 4.2kg (8.6 - 9.3lbs.)

* All list price shown are for reference only (exclude SST).

* Semua harga yang ditunjukkan adalah untuk rujukan sahaja (tidak termasuk SST). 所有显示的建议零售价仅供参考 (不包括SST)。

Cordless Impact Driver
LED Flashlight
Vacuum Cleaner
Drilling / Fastening
Impact Drilling / Demolition
Cutting
Grinding / Sanding
Sawing
Planing / Routing
Others
Outdoor Power Equipment





Cordless Combination Hammer

Tukul Kombinasi Tanpa Kord 充电式冲击钻锤



HEPA filter

Filter cleaning mechanism

Mekanisme pembersihan penapis
过滤器清洁机构

Built-in DC motor for dust collection

Motor DC terbina dalam untuk pengumpulan habuk
内置直流除尘电机

Light weight
Ringan 轻量
3.9kg
with BL4025
2.5Ah Battery



Vibration Level Tahap getaran 振动等级 **7.0m/s²**



Active Feedback Sensing Technology
Teknologi Sensor Maklum Balas Automatik
自动回饋感应科技
(HR001G / HR002G only)

Accessories (Optional)
Aksesori 配件

Dust extraction system set
Set sistem pengumpulan habuk
集尘系统

DX12
for HR001G / HR003G
Part No. 191E52-3

DX14
for HR002G
Part No. 191E58-1



HR001GM201 28mm (1-1/8")
RM 6,373

Cordless Combination Hammer
Tukul Kombinasi Tanpa Kord
充电式冲击钻锤

• Auto-start Wireless System (AWS) connects to vacuum cleaner with Bluetooth

Standard Equipment: Side Grip, Depth Gauge, Cloth, Grease Vessel (194683-7)

• M201: 1x Fast Charger, 2x 4.0Ah Battery

NEW BARU | 新

3 modes

VIDEO CLIP

Models and specs may vary by country

XGT MOTOR **BL** **XPT** **AVT** **SOFT NOLOAD** **AFT** **AWS**

Impact Energy Kekuatan Impak 单次最大冲击力	EPTA-Procedure 05/2009: 2.8J Our experimental conditions: 3.2J
Capacity Kapasiti 能力	Concrete: 28mm(1-1/8") Steel: 13mm(1/2") Wood: 32mm(1-1/4") Core Bit: 54mm(2-1/8") Diamond Core Bit (Dry Type): 65mm (2-9/16")
Impact Per Minute (IPM) Impak Per Minit 冲击数	0 - 5,000
No Load Speed (RPM) Kelajuan Tanpa Beban 回转数	0 - 980
Dimensions (L x W x H) Dimensi 体积	358x102x232mm (14-1/8"x4"x9-1/8")
Net Weight Berat Bersih 净重	3.9 - 4.6kg (8.6 - 10.1lbs.)

HR002GM201 28mm (1-1/8")
RM 6,770

Cordless Combination Hammer
Tukul Kombinasi Tanpa Kord
充电式冲击钻锤

• Auto-start Wireless System (AWS) connects to vacuum cleaner with Bluetooth

Standard Equipment: Side Grip, Depth Gauge, Cloth, Grease Vessel (194683-7), Drill Chuck (199139-5)

• M201: 1x Fast Charger, 2x 4.0Ah Battery

NEW BARU | 新

3 modes

VIDEO CLIP

Models and specs may vary by country

XGT MOTOR **BL** **XPT** **AVT** **SOFT NOLOAD** **AFT** **AWS**

Impact Energy Kekuatan Impak 单次最大冲击力	EPTA-Procedure 05/2009: 2.9J
Capacity Kapasiti 能力	Concrete: 28mm(1-1/8") Steel: 13mm(1/2") Wood: 32mm(1-1/4") Core Bit: 54mm(2-1/8") Diamond Core Bit (Dry Type): 65mm (2-9/16")
Impact Per Minute (IPM) Impak Per Minit 冲击数	0 - 5,000
No Load Speed (RPM) Kelajuan Tanpa Beban 回转数	0 - 980
Dimensions (L x W x H) Dimensi 体积	389x102x232mm (15-1/4"x4"x9-1/8")
Net Weight Berat Bersih 净重	4.1 - 4.6kg (9.0 - 10.1lbs.)

HR003GM201 | **HR003GZ** 28mm (1-1/8")
RM 5,898 | RM 2,725

Cordless Combination Hammer
Tukul Kombinasi Tanpa Kord
充电式冲击钻锤

• 3-mode operation for "Rotation Only", "Hammering with Rotation" or "Hammering Only"

Standard Equipment: Side Grip, Depth Gauge

• M201: 1x Fast Charger, 2x 4.0Ah Battery
• Z: Without Charger, Battery & Carrying Case

NEW BARU | 新

3 modes

VIDEO CLIP

Models and specs may vary by country

XGT MOTOR **BL** **XPT** **AVT**

Impact Energy Kekuatan Impak 单次最大冲击力	EPTA-Procedure 05/2009: 2.8J Our experimental conditions: 3.2J
Capacity Kapasiti 能力	Concrete: 28mm(1-1/8") Steel: 13mm(1/2") Wood: 32mm(1-1/4") Core Bit: 54mm(2-1/8") Diamond Core Bit (Dry Type): 65mm (2-9/16")
Impact Per Minute (IPM) Impak Per Minit 冲击数	0 - 5,000
No Load Speed (RPM) Kelajuan Tanpa Beban 回转数	0 - 980
Dimensions (L x W x H) Dimensi 体积	358x121x232mm (14-1/8"x4-3/4"x9-1/8")
Net Weight Berat Bersih 净重	3.9 - 4.6kg (8.6 - 10.1lbs.)

* All list price shown are for reference only (exclude SST).

* Semua harga yang ditunjukkan adalah untuk rujukan sahaja (tidak termasuk SST). 所有显示的建议零售价仅供参考 (不包括SST)。

Cordless
Tukul Tanpa Kord
LED Flashlight
Lampu Cahaya LED
VACUUM CLEANER
Penapis Habuk
Drilling / Fastening
Gredil / Pasang
Impact Drilling / Demolition
Gredil / Pasang
Cutting
Pemotongan
Grinding / Sanding
Pergasilan / Pasah
Sanding / Grinding
Garis / Pasah
Planing / Routing
Pegulangan / Tangkapan
Others
Lain-lain
Outdoor Power Equipment
Alatan Kuasa Luar





Cordless Angle Grinder

Pengisar Sudut Tanpa Kord 充电式角向磨光机

Delivers same power as 1,000W corded grinders

Memberi kuasa yang sama dengan Pengisar Sudut 1,000W
提供与1,000W有线打磨机相同的功率

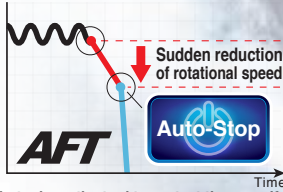

Shuts down the tool to protect the user, if the rotation speed suddenly slows down
Alat kuasa akan berhenti secara automatic untuk melindungi pengguna jika kelajuan putaran tiba-tiba melambat
若旋转速度突然降低，工具将自动关闭以保护使用者



Active Feedback Sensing Technology
Teknologi Sensor Maklum Balas Automatik
自动回馈感应科技

Model No. 型号		No Load Speed (rpm) Kelajuan Tanpa Beban 回转数	Switch Suis 开关	BL MOTOR	XPT	AFT	BRAKE	AWS	Anti-restart function Fungsi restart semula 防重启功能
100mm	125mm								
GA003G	GA005G	8,500	Slide	•	•	•	•		•
GA011G	GA013G	8,500	Paddle	•	•	•	•		•
GA021G	GA023G	3,000 - 8,500	Slide	•	•	•	•	•	•
GA027G	GA029G	3,000 - 8,500	Paddle	•	•	•	•	•	•

GA003GM201 | GA003GD201 100mm (4")
RM 4,867 | RM 4,502

Cordless Angle Grinder
Pengisar Sudut Tanpa Kord
充电式角向磨光机



Top Slide Switch

Suis Gelangsar Atas 顶部滑动开关
Convenient for left & right handed
Mudah diguna dengan tangan kiri atau kanan 方便左右手



• Excellent in continuous heavy-duty work



Standard Equipment: Grinding Wheel (A-80852), Wheel Cover, Side Grip, Lock Nut Wrench

- M201: 1x Fast Charger, 2x 4.0Ah Battery
- D201: 1x Fast Charger, 2x 2.5Ah Battery



*Not applicable for Z model



Wheel Diameter 100mm (4")
Diameter Roda 轮片直径

Hole Diameter 16mm (5/8")
Diameter Lubang 孔直径

Max Wheel Thickness 6.4mm (1/4")
Ketebalan Roda Maksimum 最大轮片厚度

No Load Speed (RPM) 8,500
Kelajuan Tanpa Beban 回转数

Dimensions (L x W x H) 398x117x150mm
Dimensi 体积

Net Weight 2.8 - 3.3kg (6.2 - 7.3lbs.)
Berat Bersih 净重

GA011GM201 | GA011GD201 100mm (4")
RM 4,960 | RM 4,595

Cordless Angle Grinder
Pengisar Sudut Tanpa Kord
充电式角向磨光机

Paddle Switch

Suis Pemicu 扳机开关



• Genuine solution for high demand industrial applications



Standard Equipment: Grinding Wheel (A-80852), Wheel Cover, Side Grip, Lock Nut Wrench

- M201: 1x Fast Charger, 2x 4.0Ah Battery
- D201: 1x Fast Charger, 2x 2.5Ah Battery



*Not applicable for Z model



Wheel Diameter 100mm (4")
Diameter Roda 轮片直径

Hole Diameter 16mm (5/8")
Diameter Lubang 孔直径

Max Wheel Thickness 6.4mm (1/4")
Ketebalan Roda Maksimum 最大轮片厚度

No Load Speed (RPM) 8,500
Kelajuan Tanpa Beban 回转数

Dimensions (L x W x H) 398x117x150mm
Dimensi 体积

Net Weight 2.8 - 3.4kg (6.2 - 7.5lbs.)
Berat Bersih 净重

GA021GM201 | GA021GD201 | GA021GZ 100mm (4")
RM 5,055 | RM 4,690 | RM 1,883

Cordless Angle Grinder
Pengisar Sudut Tanpa Kord
充电式角向磨光机

Top Slide Switch

Suis Gelangsar Atas 顶部滑动开关
Convenient for left & right handed
Mudah diguna dengan tangan kiri atau kanan 方便左右手



• Auto-start Wireless System (AWS) connects to compatible vacuum cleaners with Bluetooth



Standard Equipment: Grinding Wheel (A-80852), Wheel Cover, Side Grip, Lock Nut Wrench

- M201: 1x Fast Charger, 2x 4.0Ah Battery
- D201: 1x Fast Charger, 2x 2.5Ah Battery
- Z: Without Charger, Battery & Carrying Case



*Not applicable for Z model



Wheel Diameter 100mm (4")
Diameter Roda 轮片直径

Hole Diameter 16mm (5/8")
Diameter Lubang 孔直径

Max Wheel Thickness 6.4mm (1/4")
Ketebalan Roda Maksimum 最大轮片厚度

No Load Speed (RPM) 3,000 - 8,500
Kelajuan Tanpa Beban 回转数

Dimensions (L x W x H) 413x117x150mm
Dimensi 体积

Net Weight 2.8 - 3.4kg (6.2 - 7.5lbs.)
Berat Bersih 净重

* All list price shown are for reference only (exclude SST).

* Semua harga yang ditunjukkan adalah untuk rujukan sahaja (tidak termasuk SST). 所有显示的建议零售价仅供参考 (不包括SST)。

Cordless
Tampal Kord Tanpa Kord

LED Flashlight
Lampu Suluh LED
LED 手电筒

Vacuum Cleaner
Penyedut Vakuum
吸尘器

Drilling / Fastening
Ganda / Pengikat
钻孔 / 紧固

Impact Drilling / Demolition
Ganda / Pemusnah
钻孔 / 拆除

Cutting
Pemotong
切割

Grinding / Sanding
Pengisar / Haisah
磨削 / 打磨

Sawing
Ganda
锯切

Planing / Routing
Pengisar / Tonggah
刨削 / 开槽

Others
Lain-lain
其他

Outdoor Power Equipment
Alatan Kuasa Luar
户外动力工具

Makita
MAKITA

GA027GM201 RM 5,152 | **GA027GD201** RM 4,787 | **GA027GZ** 100mm (4") RM 1,980

Cordless Angle Grinder
Pengisar Sudut Tanpa Kord
充电式角向磨光机

Paddle Switch
Suis Pemicu 拨机开关



- Auto-start Wireless System (AWS) connects to compatible vacuum cleaners with Bluetooth

Standard Equipment: Grinding Wheel (A-80852), Wheel Cover, Side Grip, Lock Nut Wrench

- M201: 1x Fast Charger, 2x 4.0Ah Battery
- D201: 1x Fast Charger, 2x 2.5Ah Battery
- Z: Without Charger, Battery & Carrying Case



Wheel Diameter Diameter Roda 轮片直径	100mm (4")
Hole Diameter Diameter Lubang 孔直径	16mm (5/8")
Max Wheel Thickness Ketebalan Roda Maksimum 最大轮片厚度	6.4mm (1/4")
No Load Speed (RPM) Kelajuan Tanpa Beban 回转数	3,000 - 8,500
Dimensions (L x W x H) Dimensi 体积	413x117x150mm (16-1/4"x4-5/8"x5-7/8")
Net Weight Berat Bersih 净重	2.9 - 3.4kg (6.4 - 7.5lbs.)

GA005GM201 RM 4,865 | **GA005GD201** RM 4,502 | 125mm (5")

Cordless Angle Grinder
Pengisar Sudut Tanpa Kord
充电式角向磨光机

Top Slide Switch
Suis Gelang Atas 顶部滑动开关
Convenient for left & right handed
Mudah diguna dengan tangan kiri atau kanan 方便左右操作



- Genuine solution for high demand industrial applications

Standard Equipment: Grinding Wheel (A-80656), Wheel Cover, Side Grip, Lock Nut Wrench

- M201: 1x Fast Charger, 2x 4.0Ah Battery
- D201: 1x Fast Charger, 2x 2.5Ah Battery



Wheel Diameter Diameter Roda 轮片直径	125mm (5")
Hole Diameter Diameter Lubang 孔直径	22.23mm (7/8")
Max Wheel Thickness Ketebalan Roda Maksimum 最大轮片厚度	7.2mm (9/32")
No Load Speed (RPM) Kelajuan Tanpa Beban 回转数	8,500
Dimensions (L x W x H) Dimensi 体积	398x140x156mm (15-5/8"x5-1/2"x6-1/8")
Net Weight Berat Bersih 净重	2.9 - 3.6kg (6.4 - 7.9lbs.)

GA013GM201 RM 4,960 | **GA013GD201** RM 4,595 | 125mm (5")

Cordless Angle Grinder
Pengisar Sudut Tanpa Kord
充电式角向磨光机

Paddle Switch
Suis Pemicu 拨机开关



- BL motor to run cooler and more efficiently for longer life

Standard Equipment: Grinding Wheel (A-80656), Wheel Cover, Side Grip, Lock Nut Wrench

- M201: 1x Fast Charger, 2x 4.0Ah Battery
- D201: 1x Fast Charger, 2x 2.5Ah Battery



Wheel Diameter Diameter Roda 轮片直径	125mm (5")
Hole Diameter Diameter Lubang 孔直径	22.23mm (7/8")
Max Wheel Thickness Ketebalan Roda Maksimum 最大轮片厚度	7.2mm (9/32")
No Load Speed (RPM) Kelajuan Tanpa Beban 回转数	8,500
Dimensions (L x W x H) Dimensi 体积	398x140x156mm (15-5/8"x5-1/2"x6-1/8")
Net Weight Berat Bersih 净重	3.0 - 3.6kg (6.6 - 7.9lbs.)



GA023GM201 RM 5,057 | **GA023GD201** RM 4,692 | **GA023GZ** 125mm (5") RM 1,885

Cordless Angle Grinder
Pengisar Sudut Tanpa Kord
充电式角向磨光机

Top Slide Switch
Suis Gelang Atas 顶部滑动开关
Convenient for left & right handed
Mudah diguna dengan tangan kiri atau kanan 方便左右操作



- Auto-start Wireless System (AWS) connects to compatible vacuum cleaners with Bluetooth

Standard Equipment: Grinding Wheel (A-80656), Wheel Cover, Side Grip, Lock Nut Wrench

- M201: 1x Fast Charger, 2x 4.0Ah Battery
- D201: 1x Fast Charger, 2x 2.5Ah Battery
- Z: Without Charger, Battery & Carrying Case



Wheel Diameter Diameter Roda 轮片直径	125mm (5")
Hole Diameter Diameter Lubang 孔直径	22.23mm (7/8")
Max Wheel Thickness Ketebalan Roda Maksimum 最大轮片厚度	7.2mm (9/32")
No Load Speed (RPM) Kelajuan Tanpa Beban 回转数	3,000 - 8,500
Dimensions (L x W x H) Dimensi 体积	413x140x156mm (16-1/4"x5-1/2"x6-1/8")
Net Weight Berat Bersih 净重	3.0 - 4.4kg (6.6 - 9.7lbs.)

GA029GM201 RM 5,152 | **GA029GD201** RM 4,787 | **GA029GZ** 125mm (5") RM 1,980

Cordless Angle Grinder
Pengisar Sudut Tanpa Kord
充电式角向磨光机

Paddle Switch
Suis Pemicu 拨机开关



- Auto-start Wireless System (AWS) connects to compatible vacuum cleaners with Bluetooth

Standard Equipment: Grinding Wheel (A-80656), Wheel Cover, Side Grip, Lock Nut Wrench

- M201: 1x Fast Charger, 2x 4.0Ah Battery
- D201: 1x Fast Charger, 2x 2.5Ah Battery
- Z: Without Charger, Battery & Carrying Case



Wheel Diameter Diameter Roda 轮片直径	125mm (5")
Hole Diameter Diameter Lubang 孔直径	22.23mm (7/8")
Max Wheel Thickness Ketebalan Roda Maksimum 最大轮片厚度	7.2mm (9/32")
No Load Speed (RPM) Kelajuan Tanpa Beban 回转数	3,000 - 8,500
Dimensions (L x W x H) Dimensi 体积	413x140x156mm (16-1/4"x5-1/2"x6-1/8")
Net Weight Berat Bersih 净重	3.0 - 4.5kg (6.6 - 9.9lbs.)

* All list price shown are for reference only (exclude SST).

* Semua harga yang ditunjukkan adalah untuk rujukan sahaja (tidak termasuk SST). 所有显示的建议零售价仅供参考 (不包括SST)。

Cordless
Target Speed 3000-8500 RPM

LED Flashlight
Lampu Sinar LED
LECOBRIGHT

Vacuum Cleaner
Penyedut Vakuum
ELECTRIC

Drilling / Fastening
Gruel / Pasak
METAL / 螺絲

Impact Drilling / Demolition
Gruel / Pasak
METAL / 螺絲

Cutting
Pemotong
STEEL

Grinding / Sanding
Pengisar / Pasak
METAL / 螺絲

Sanding
Gruel
METAL

Planing / Routing
Pengisar / Pasak
METAL / 螺絲

Others
Lain-lain
METAL

Outdoor Power Equipment
Alatan Kuat Listrik
METAL

Thakita
METAL



Cordless Circular Saw

Gergaji Piring Tanpa Kord 充电式圆锯



Light weight
Ringan 轻量
4.7kg
with BL4040
4.0Ah Battery



Compatible with guide rail without adapter
Boleh bersambung dengan rel panduan tanpa penyesuai 直接连接导轨使用

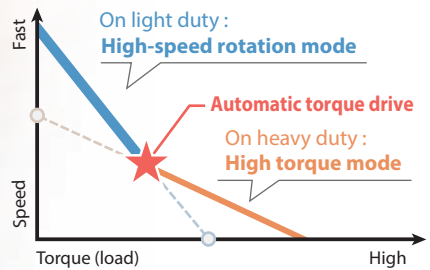

ADT
Automatic Torque Drive Technology
Teknologi Tork Automatik
自动扭力驱动科技

HS004GM201 | **HS004GZ** 190 / 185mm (7-1/2" / 7-1/4")
RM 6,220 | RM 3,048

Cordless Circular Saw
Gergaji Piring Tanpa Kord
充电式圆锯



- Lightweight & High Power
- Standard Equipment: TCT Saw Blade (B-62022), Dust Nozzle, Hex Wrench, Guide Rule
- M201: 1x Fast Charger, 2x 4.0Ah Battery
 - Z: Without Charger, Battery & Carrying Case

Blade Diameter Diameter Bilah 锯片直径	190mm (7-1/2") 185mm (7-1/4")
Hole Diameter Diameter Lubang 孔直径	15.88mm (5/8") 20mm (13/16") 30mm (1-3/16")
Max Cutting Capacity Kapasiti Pemotongan Maksimum 最大切割能力	90°: 62.5 / 60 mm (2-7/16" / 2-3/8") 45°: 44.5 / 43 mm (1-3/4" / 1-11/16") 48°: 42 / 41 mm (1-5/8" / 1-5/8")
No Load Speed (RPM) Kelajuan Tanpa Beban 回转数	6,000
Dimensions (L x W x H) Dimensi 体积	322x210x290mm (12-5/8"x8-1/4"x11-3/8")
Net Weight Berat Bersih 净重	4.4 - 4.7kg (9.7 - 10.4lbs.)

Cordless Recipro Saw

Gergaji Resipro Tanpa Kord 充电式往复锯

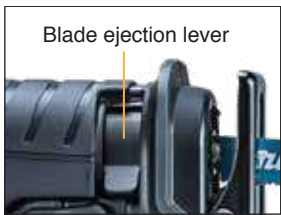

Light weight
Ringan 轻量
4.2kg
with BL4025
2.5Ah Battery



Toolless blade change
Penggantian bilah tanpa alat 免工具更换锯片

JR001GM201 | **JR001GZ**
RM 5,312 | RM 2,140

Cordless Recipro Saw
Gergaji Resipro Tanpa Kord
充电式往复锯



- Compact & High Power

Length of Stroke Panjang Strok 冲程长度	32mm (1-1/4")
Strokes Per Minute (SPM) Kelajuan Strok 冲程速度	High: 0 - 3,000 Low: 0 - 2,300
Capacity Kapasiti 能力	Pipe: 130mm (5-1/8") Wood: 255mm (10")
Dimensions (L x W x H) Dimensi 体积	457x88x233mm (18"x3-1/2"x9-1/8")
Net Weight Berat Bersih 净重	4.2 - 4.5kg (9.3 - 9.9lbs.)

Standard Equipment:
Recipro Saw Blades 3pcs (B-05038, B-05044, B-05153)

- M201: 1x Fast Charger, 2x 4.0Ah Battery
- Z: Without Charger, Battery & Carrying Case



* All list price shown are for reference only (exclude SST).

* Semua harga yang ditunjukkan adalah untuk rujukan sahaja (tidak termasuk SST). 所有显示的建议零售价仅供参考 (不包括SST)。

Cordless Impact Drill
LED Flashlight
Vacuum Cleaner
Drilling / Fastening
Impact Drilling / Demolition
Cutting
Grinding / Sanding
Sawing
Planing / Routing
Others
Outdoor Power Equipment





Li-ion Ah 6.0 5.0 4.0 3.0 2.0 1.5

Cordless Rotary Hammer

Tukul Putar Tanpa Kord 充电式电钻

Accessories (Optional)

Aksesori 配件



Dust Extractor Attachment Set
Part No. 196536-6



VIDEO CLIP
Models and specs may vary by country
DHR400N

DHR400ZKN 40mm (1-9/16")
RM 5,552

Cordless Rotary Hammer

Tukul Putar Tanpa Kord
充电式电钻



- High power and excellent performance

Standard Equipment: Side Handle, Side Grip, Depth Gauge, Bit Grease (194683-7), Cleaning Cloth

- ZKN: Without Charger & Battery



Impact Energy Kekuatan Impak 单次最大锤击力	EPTA-Procedure 05/2009: 8.0J Our experimental conditions: 11.4J
Capacity Kapasiti 能力	Concrete (TCT Bit): 40mm (1-9/16") Concrete (Core Bit): 105mm (4-1/8")
Impacts Per Minute (IPM) Impak Per Minit 冲击数	1,450 - 2,900
No Load Speed (RPM) Kelajuan Tanpa Beban 回转数	250 - 500
Dimensions (L x W x H) Dimensi 体积	473x120x285mm (18-5/8"x4-3/4"x11-1/4")
Net Weight Berat Bersih 净重	7.3 - 8.1kg (16.1 - 17.9lbs.)
Work Amount (approx.) Jumlah Kerja 工作量	25 holes with BL1850B x2 Concrete Grade 40 D18mm x 140mm Depth

Cordless Combination Hammer

Tukul Kombinasi Tanpa Kord 充电式冲击电钻电锤

Accessories (Optional)

Aksesori 配件



HEPA Filter
Part No. 199557-7

Dust cup
Part No. 195173-3

Dust case
Part No. 199555-1

DX08
for DHR280, DHR282

Dust extraction system set
Part No. 199579-7



DHR282PT2J **DHR282Z** 28mm (1-1/8")
RM 3,818 RM 2,233

Cordless Combination Hammer

Tukul Kombinasi Tanpa Kord
充电式冲击电钻电锤



- Auto-start Wireless System (AWS) connects to vacuum cleaner with Bluetooth

Standard Equipment: Side Grip, Depth Gauge, Cleaning Cloth, Bit Grease (194683-7)

- PT2J: 1x Two Port Multi Fast Charger, 2x 5.0Ah Battery, 1x Makpac Connector Box
- Z: Without Charger, Battery & Carrying Case



Impact Energy Kekuatan Impak 单次最大锤击力	EPTA-Procedure 05/2009: 2.8J Our experimental conditions: 3.2J
Capacity Kapasiti 能力	Concrete: 28mm (1-1/8") Steel: 13mm (1/2") Wood: 32mm (1-1/4") Core Bit: 54mm (2-1/8") Diamond Core Bit (Dry Type): 65mm (2-9/16")
Impacts Per Minute (IPM) Impak Per Minit 冲击数	0 - 5,000
No Load Speed (RPM) Kelajuan Tanpa Beban 回转数	0 - 980
Chuck Capacity Kapasiti Chuck 夹头能力	1.5 - 13mm (1/16 - 1/2")
Max Output Keluasan Maksima 最大输出	680W
Dimensions (L x W x H) Dimensi 体积	373x134x232mm (14-3/4"x5-1/4"x9-1/8")
Net Weight Berat Bersih 净重	3.9 - 5.0 kg (8.6 - 11.0 lbs.)
Work Amount (approx.) Jumlah Kerja 工作量	187 holes with BL1850B x2 Concrete Grade 40 D10.5mm x 60mm Depth

DHR280PT2J **DHR280Z** 28mm (1-1/8")
RM 3,632 RM 2,045

Cordless Combination Hammer

Tukul Kombinasi Tanpa Kord
充电式冲击电钻电锤



- High Power and Low Vibration

Standard Equipment: Side Grip, Depth Gauge, Cleaning Cloth, Bit Grease (194683-7)

- PT2J: 1x Two Port Multi Fast Charger, 2x 5.0Ah Battery, 1x Makpac Connector Box
- Z: Without Charger, Battery & Carrying Case



Impact Energy Kekuatan Impak 单次最大锤击力	EPTA-Procedure 05/2009: 2.8J Our experimental conditions: 3.2J
Capacity Kapasiti 能力	Concrete: 28mm (1-1/8") Steel: 13mm (1/2") Wood: 32mm (1-1/4") Core Bit: 54mm (2-1/8") Diamond Core Bit (Dry Type): 65mm (2-9/16")
Impacts Per Minute (IPM) Impak Per Minit 冲击数	0 - 5,000
No Load Speed (RPM) Kelajuan Tanpa Beban 回转数	0 - 980
Chuck Capacity Kapasiti Chuck 夹头能力	1.5 - 13mm (1/16 - 1/2")
Max Output Keluasan Maksima 最大输出	680W
Dimensions (L x W x H) Dimensi 体积	373x134x232mm (14-3/4"x5-1/4"x9-1/8")
Net Weight Berat Bersih 净重	3.9 - 4.9 kg (8.6 - 10.8 lbs.)
Work Amount (approx.) Jumlah Kerja 工作量	187 holes with BL1850B x2 Concrete Grade 40 D10.5mm x 60mm Depth

* All list price shown are for reference only (exclude SST).

* Semua harga yang ditunjukkan adalah untuk rujukan sahaja (tidak termasuk SST). 所有显示的建议零售价仅供参考 (不包括SST)。

Cordless
Targeted Speed
LED Flashlight
Lampu Cahaya LED
LEDFLASH
Vacuum Cleaner
Penyedut Vakuum
VESSEL
Drilling / Fastening
Gruat / Pasang
METS / 螺絲
Impact Drilling / Demolition
Gruat / Pasang
METS / 螺絲
Cutting
Pemotong
SATA
Grinding / Sanding
Pegilang / Pasang
METS / 螺絲
Sanding
Gruat
METS
Planing / Routing
Pegilang / Tangkapan
METS / 螺絲
Others
Lain-lain
METS
Outdoor Power Equipment
Alatan Kerja Luar
METS / 螺絲
Makita
1915



Li-ion Ah 6.0 5.0 4.0 3.0 2.0 1.5

DHR263PM4 RM 4,042 | **DHR263RF4** RM 3,413 | **DHR263Z** 26mm (1") RM 1,798 442 mm

Cordless Combination Hammer

Tukul Kombinasi Tanpa Kord
充电式冲击钻锤



- 3-Mode operation for Rotation Only, Hammering with Rotation or Hammering Only

Standard Equipment: Side Grip, Depth Gauge, Cleaning Cloth, Bit Grease (194683-7)

- PM4: 1x Two Port Multi Fast Charger, 4x 4.0Ah Battery, 1x Tool Bag
- RF4: 1x Rapid Charger, 4x 3.0Ah Battery, 1x Carrying Case
- Z: Without Charger, Battery & Carrying Case



*Not applicable for Z model



Impact Energy Kekuatan Impak 单次最大冲击力	EPTA-Procedure 05/2009: 2.5J Our experimental conditions: 3.0J
Capacity Kapasiti 能力	Concrete: 26mm (1") Steel: 13mm (1/2") Wood: 32 mm (1-1/4")
Impacts Per Minute (IPM) Impak Per Minit 冲击数	0 - 5,000
No Load Speed (RPM) Kelajuan Tanpa Beban 回转数	0 - 1,250
Dimensions (L x W x H) Dimensi 体积	350x116x232mm (13-3/4"x4-9/16"x9-1/8")
Net Weight Berat Bersih 净重	4.1 - 5.1kg (9.0 - 11.3lbs)
Work Amount (approx.) Jumlah Kerja 工作量	133 holes with BL1850B x2 Concrete Grade 40 D10.5mm x 60mm Depth

DDA460ZK 13mm (1/2") RM 3,790

Cordless Angle Drill
Gerudi Sudut Tanpa Kord
充电式角向电钻



- Powerful drilling even large diameter holes

Standard Equipment: Chuck Key, Hex Wrench, Side Grip

- ZK: Without Charger & Battery



VIDEO CLIP
Models and specs may vary by country

Capacity Kapasiti 能力	Steel: 13mm (1/2") Wood (Self-Feed Bit) Hi: 65mm (2-9/16") Wood (Self-Feed Bit) Lo: 118mm (4-5/8") Wood (Hole Saw) Hi: 105mm (4-1/8") Wood (Hole Saw) Lo: 159mm (6-1/4") Wood (Auger-Bit): 50mm (2")
No Load Speed (RPM) Kelajuan Tanpa Beban 回转数	High: 0 - 1,400 Low: 0 - 350
Max Fastening Torque Maksimum Tenaga Pemutaran Pengancing 最快扭力	High: 48N·m (430 in.lbs.) Low: 136N·m (1,210 in.lbs.)
Max Output Keluasan Maksima 最大输出	1,350 W
Dimensions (L x W x H) Dimensi 体积	538x128x223mm (21-1/4"x5"x8-3/4")
Net Weight Berat Bersih 净重	5.7 - 6.4kg (12.6 - 14.0lbs.)
Work Amount (approx.) Jumlah Kerja 工作量	80 holes with BL1850B x2 2 Layered SPF

Cordless Shear Wrench

Perengkuh Ricih Tanpa Kord 充电式扭断套筒扳手

Accessories (Optional)
Aksesori 配件



Sleeve size reference table
Pemilihan operasi 3-mod 3模式选择
*Type F (for HEXA TECH (GFD France)) ** for Chinese market

Bolt Size	Outer sleeve		Inner sleeve	
	L (mm)	Part No.	L (mm)	Part No.
M16	35	193804-8	36	195245-4
			36	*764421-7
M16	81	193807-2	82	193810-3
M16	100	764406-3	100	764400-5
M16	200	764407-1	200	764401-3
M20	37	193805-6	38	195217-9
M20	37	**196276-6		
M20	37	193805-6	38	*764422-5
M20	83	193806-4	84	193809-8
M20	100	764408-9	100	764402-1
M20	200	764409-7	200	764403-9

Bolt Size	Outer sleeve		Inner sleeve	
	L (mm)	Part No.	L (mm)	Part No.
M22, 7/8"	39	193960-4	39	195218-7
M22, 7/8"	85	764364-3	85	*764423-3
M22, 7/8"	100	764410-2	100	764404-7
M22, 7/8"	170	764365-1	170	764354-6
M22, 7/8"	200	764411-0	200	764405-5
5/8"	35	764362-7	36	764420-9
3/4"	37	764361-9	38	764419-4
3/4"	83	764363-5	84	764353-8
3/4"	168	764366-9	169	764355-4



DWT310ZK M20 (3/4"), M22 (7/8") RM 17,093

Cordless Shear Wrench
Perengkuh Ricih Tanpa Kord
充电式扭断套筒扳手



- Up to 14% Faster Fastening than Corded Model 6922NB

Standard Equipment: Screwdriver, Shoulder Belt, M20 Sleeve, M22 Sleeve

- ZK: Without Charger & Battery



Capacity Kapasiti 能力	High Strength Torque Shear Bolt (HTB): M16 (optional), M20, M22 (5/8", 3/4", 7/8") Super High Strength Torque Shear Bolt (SHTB): M16, M20 (5/8", 3/4")
No Load Speed (RPM) Kelajuan Tanpa Beban 回转数	14
Max Fastening Torque Maksimum Tenaga Pemutaran Pengancing 最快扭力	804N·m (593ft.lbs.)
Dimensions (L x W x H) Dimensi 体积	296x130x377mm (11-5/8"x5-1/8"x14-7/8")
Net Weight Berat Bersih 净重	6.5 - 7.1kg (14.3 - 15.7lbs.)
Work Amount (approx.) Jumlah Kerja 工作量	300 pcs with BL1850B x2 M22 (7/8") Torque Shear Bolts

* All list price shown are for reference only (exclude SST).

* Semua harga yang ditunjukkan adalah untuk rujukan sahaja (tidak termasuk SST). 所有显示的建议零售价仅供参考 (不包括SST)。

Cordless Impact Driver
LED Flashlight
Vacuum Cleaner
Drilling / Fastening
Impact Drilling / Demolition
Cutting
Grinding / Sanding
Sawing
Planing / Routing
Others
Outdoor Power Equipment





Li-ion Ah 6.0 5.0 4.0 3.0 2.0 1.5



Cordless Angle Grinder

Pengisar Sudut Tanpa Kord 充电式角向磨光机

DGA701Z 180mm (7")

RM 1,795

Cordless Angle Grinder
Pengisar Sudut Tanpa Kord
充电式角向磨光机



- Auto-start Wireless System (AWS) connects to vacuum cleaner with Bluetooth



Standard Equipment: Wheel Cover, Side Grip, Lock Nut Wrench

• Z: Without Charger & Battery



Wheel Diameter Diameter Mata Canai 砂轮片直径	180mm (7")
Hole Diameter Diameter Lubang 孔直径	22.23mm (7/8")
Max Wheel Thickness Ketebalan Roda 轮片厚度	7.2 mm (1/4")
No Load Speed (RPM) Kelajuan Tanpa Beban 回转数	7,800
Max Output Keluasan Maksima 最大输出	1,500W
Dimensions (L x W x H) Dimensi 体积	499x200x158mm (19-5/8"x7-7/8"x6-1/4")
Net Weight Berat Bersih 净重	5.0 - 6.0kg (11.0 - 13.3lbs.)
Work Amount (approx.) Jumlah Kerja 工作量	17 cuts with BL1850B x2 Equiangular Angle Steel 50 x 50mm

DGA700Z 180mm (7")

RM 1,605

Cordless Angle Grinder
Pengisar Sudut Tanpa Kord
充电式角向磨光机



- Electric brake stops the grinding wheel in 4.5 seconds or less for increased operator safety



Standard Equipment: Wheel Cover, Side Grip, Lock Nut Wrench

• Z: Without Charger & Battery



Wheel Diameter Diameter Mata Canai 砂轮片直径	180mm (7")
No Load Speed (RPM) Kelajuan Tanpa Beban 回转数	7,800
Dimensions (L x W x H) Dimensi 体积	499x200x158mm (19-5/8"x7-7/8"x6-1/4")
Net Weight Berat Bersih 净重	5.0 - 6.0kg (11.02 - 13.23lbs)
Work Amount (approx.) Jumlah Kerja 工作量	17 cuts with BL1850B x2 Equiangular Angle Steel 50 x 50mm

DGA901Z 230mm (9")

RM 1,810

Cordless Angle Grinder
Pengisar Sudut Tanpa Kord
充电式角向磨光机



- Auto-start Wireless System (AWS) connects to vacuum cleaner with Bluetooth



Standard Equipment: Wheel Cover, Side Grip, Lock Nut Wrench

• Z: Without Charger & Battery



Wheel Diameter Diameter Mata Canai 砂轮片直径	230mm (9")
Hole Diameter Diameter Lubang 孔直径	22.23mm (7/8")
Max Wheel Thickness Ketebalan Roda 轮片厚度	6.5mm (1/4")
No Load Speed (RPM) Kelajuan Tanpa Beban 回转数	6,000
Max Output Keluasan Maksima 最大输出	1,500W
Dimensions (L x W x H) Dimensi 体积	499x250x158mm (19-5/8"x9-7/8"x6-1/4")
Net Weight Berat Bersih 净重	5.2 - 8.0kg (11.46 - 17.64lbs.)
Work Amount (approx.) Jumlah Kerja 工作量	17 cuts with BL1850B x2 Equiangular Angle Steel 50 x 50mm

DGA900Z 230mm (9")

RM 1,623

Cordless Angle Grinder
Pengisar Sudut Tanpa Kord
充电式角向磨光机



- Electric brake stops the grinding wheel in 4.5 seconds or less for increased operator safety



Standard Equipment: Wheel Cover, Side Grip, Lock Nut Wrench

• Z: Without Charger & Battery



Wheel Diameter Diameter Mata Canai 砂轮片直径	230mm (9")
No Load Speed (RPM) Kelajuan Tanpa Beban 回转数	6,000
Dimensions (L x W x H) Dimensi 体积	499x250x158mm (19-5/8"x9-7/8"x6-1/4")
Net Weight Berat Bersih 净重	5.2 - 8.0kg (11.46 - 17.64lbs)
Work Amount (approx.) Jumlah Kerja 工作量	17 cuts with BL1850B x2 Equiangular Angle Steel 50 x 50mm

* All list price shown are for reference only (exclude SST).

* Semua harga yang ditunjukkan adalah untuk rujukan sahaja (tidak termasuk SST). 所有显示的建议零售价仅供参考 (不包括SST)。

Cordless
Tanpa Kord 充电式

LED Flashlight
Lampu Suhu LED
LED照明灯

Vacuum Cleaner
Penyedut Vakuum
吸尘器

Drilling / Fastening
Gredil / Pengikat
钻孔 / 紧固

Impact Drilling / Demolition
Gredil / Pencah
冲击钻孔 / 拆除

Cutting
Pemotong
切割

Grinding / Sanding
Pengisar / Gredil
磨光 / 打磨

Sawing
Gergaji
锯切

Planing / Routing
Penghalus / Tangkapan
刨平 / 铣削

Others
Lain-lain
其他

Outdoor Power Equipment
Alatan Kerja Luar
户外动力设备

Thakita
TINTA



Li-ion Ah 6.0 5.0 4.0 3.0 2.0 1.5

DSP601Z **DSP600Z** 165mm (6-1/2")
RM 3,273 RM 2,678

Cordless Plunge Cut Saw
Pensidar Sudut Tanpa Kord
充电式角向磨光机



- Auto-start Wireless System (AWS) connects to vacuum cleaner with Bluetooth



Standard Equipment: TCT Saw Blade (B-57364), Hex Wrench

- Z: Without Charger & Battery

ONLY FOR DSP601



Blade Diameter Diameter Bilah 锯片直径	165mm (6-1/2")
Bevel Capacity Kapasiti Bevel 斜角容量	-1° - 48°
Max Cutting Capacity Kapasiti Pemotongan Maksimum 最大切割能力	90°: 56mm (2-3/16") 45°: 40 mm (1-9/16") 48°: 38 mm (1-1/2")
No Load Speed (RPM) Kelajuan Tanpa Beban 回转速数	2,500 - 6,300
Dimensions (L x W x H) Dimensi 体积	346x241x272mm (13-5/8"x9-1/2"x10-3/4")
Net Weight Berat Bersih 淨重	4.4 - 5.1kg (9.8 - 11.2lbs.)
Work Amount (approx.) Jumlah Kerja 工作量	48 cuts with BL1850B x2 Melamine Board 32mm (Thick) x 1000mm (Length)

Cordless Slide Compound Miter Saw

Gergaji Kompaun Miter Tanpa Kord 充电式斜断锯



DLS211Z 305mm (12")
RM 6,132

Cordless Slide Compound Miter Saw
Gergaji Kompaun Miter Tanpa Kord
充电式斜断锯



- Auto-start Wireless System (AWS) connects to vacuum cleaner with Bluetooth



Standard Equipment: TCT Saw Blade (B-67452), Dust Bag (1228520), Triangular Rule, Vertical Vise, Hex Wrench

- Z: Without Charger & Battery



Blade Diameter Diameter Bilah 锯片直径	305mm (12")
Miter Angle Sudut Miter 斜接角	60°L / 60°R
Bevel Angle Sudut Bevel 斜角	48°L / 48°R
Max Cutting Capacity Kapasiti Pemotongan Maksimum 最大切割能力	90°Miter: 107 x 363mm (4-1/4" x 14-1/4") 90° Miter: 92 x 382mm (3-5/8" x 15") 45° Miter, L/R: 107 x 255mm (4-1/4" x 10") 45° Miter, L/R: 92 x 268mm (3-5/8" x 10-1/2")
No Load Speed (RPM) Kelajuan Tanpa Beban 回转速数	4,400
Dimensions (L x W x H) Dimensi 体积	898x690x725mm (35-1/4"x27-1/4"x28-1/2")
Net Weight Berat Bersih 淨重	30.7 - 31.3kg (67.6 - 69.1lbs.)

DLS111Z 260mm (10-1/4")
RM 5,353

Cordless Slide Compound Miter Saw
Gergaji Kompaun Miter Tanpa Kord
充电式斜断锯



- Auto-start Wireless System (AWS) connects to vacuum cleaner with Bluetooth



Standard Equipment: TCT Saw Blade (B-64668), Dust Bag (1228520), Triangular Rule, Vertical Vise, Hex Wrench

- Z: Without Charger & Battery



Blade Diameter Diameter Bilah 锯片直径	260mm (10-1/4")
Miter Angle Sudut Miter 斜接角	60°L / 60°R
Bevel Angle Sudut Bevel 斜角	48°L / 48°R
Max Cutting Capacity Kapasiti Pemotongan Maksimum 最大切割能力	90° Miter: 91 x 279mm (3-5/8" x 11") 90° Miter: 68 x 310mm (2-11/16" x 12-1/4") 45° Miter, L/R: 91 x 197mm (3-5/8" x 7-3/4") 45° Miter, L/R: 68 x 218mm (2-11/16" x 8-5/8")
No Load Speed (RPM) Kelajuan Tanpa Beban 回转速数	4,400
Dimensions (L x W x H) Dimensi 体积	805x644x660mm (31-3/4"x25-3/8"x26")
Net Weight Berat Bersih 淨重	26.6 - 27.3kg (58.6 - 60.2 lbs.)

DLS714PM2 **DLS714Z** 190mm (7-1/2")
RM 5,813 RM 4,373

Cordless Slide Compound Miter Saw
Gergaji Kompaun Miter Tanpa Kord
充电式斜断锯



- Large cutting capacity; Crosscuts up to 52 x 300 mm (2-1/16" x 11-3/4") at 90°



Standard Equipment: TCT Saw Blade (B-03850), Dust Bag (1228520), Holder Set, Vertical Vise, Hex Wrench, Triangular Rule

- PM2: 1x Two Port Multi Fast Charger, 2x 4.0Ah Battery
- Z: Without Charger & Battery



Blade Diameter Diameter Bilah 锯片直径	190mm (7-1/2")
Miter Angle Sudut Miter 斜接角	47°L / 57°R
Bevel Angle Sudut Bevel 斜角	45°L / 5°R
Max Cutting Capacity Kapasiti Pemotongan Maksimum 最大切割能力	90°: 52 x 300mm (2-1/16" x 11-3/4") at 45° left: 40 x 300mm (1-9/16" x 11-3/4") at 5° right: 40 x 300mm (1-9/16" x 11-3/4")
No Load Speed (RPM) Kelajuan Tanpa Beban 回转速数	5,700
Dimensions (L x W x H) Dimensi 体积	655x430x445mm (25-3/4"x17"x17-1/2")
Net Weight Berat Bersih 淨重	12.6kg (27.8lbs)
Work Amount (approx.) Jumlah Kerja 工作量	350 pcs with BL1850B x2 SPF Material 2x4"

* All list price shown are for reference only (exclude SST).

* Semua harga yang ditunjukkan adalah untuk rujukan sahaja (tidak termasuk SST). 所有显示的建议零售价仅供参考 (不包括SST)。

Cordless
Tampal Kord Tanpa Kord

LED Flashlight
Lampu Suluh LED
LED 手電筒

Vacuum Cleaner
Penisarah Vakuam
吸尘器

Drilling / Fastening
Draib / Pengikat
鑽孔 / 鎖緊

Impact Drilling / Demolition
Draib / Pemusnah
鑽孔 / 破壞

Cutting
Pemotong
切割

Grinding / Sanding
Pengisar / Habis
磨 / 砂

Sawing
Gergaji
鋸

Planing / Routing
Pegangan / Tengam
刨 / 磨

Others
Lain-lain
其他

Outdoor Power Equipment
Alatan Kuasa Luar
戶外電力

Makita
MAKITA



Li-ion Ah 6.0 5.0 4.0 3.0 2.0 1.5

DJR360RF4 DJR360Z
RM 3,382 RM 1,768

Cordless Recipro Saw
Gergaji Resipro Tanpa Kord
充电式往复锯



- Electric 2 speed provides ideal RPM of high speed for wooden cutting and low speed for metal cutting

Standard Equipment: Recipro Saw Blades 2pcs (B-05175 & B-05169)

- RF4: 1x Rapid Charger, 4x 3.0Ah Battery
- Z: Without Charger, Battery & Carrying Case

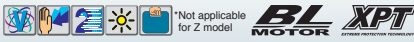

Length of Stroke Panjang Strok 冲程长度	32mm (1-1/4")
Strokes Per Minute (SPM) Kelajuan Strok 冲程速度	High: 0 - 3,000 Low: 0 - 2,300
Capacity Kapasiti 能力	Pipe: 130mm (5-1/8") Wood: 255mm (10")
Dimensions (L x W x H) Dimensi 体积	449x116x243mm (17-3/4"x4-9/16"x9-9/16")
Net Weight Berat Bersih 淨重	4.0 - 4.7kg (8.9 - 10.3lbs)
Work Amount (approx.) Jumlah Kerja 工作量	110 pcs with BL1850B x2 Steel Pipe (φ34 x 3mm)

Cordless Portable Cut-off

Mesin Pemotong Tanpa Kord 充电式无刷轻钢架砂轮切断机

CUTTING CAPACITY

A workpiece thinner than 1.6mm is recommended for cutting with this tool

Form of Materials	Diagram	Diagram	Diagram	Diagram
Miter Angle 0°	D: ø127mm (5")	H x W: 115 x 130 (4-1/2"x5-1/8") 102 x 194mm (4"x 7-5/8") 70 x 233mm (2-3/4"x 9-1/8")	H x W: 119 x 119mm (4-11/16"x 4-11/16")	S x S: 137 x 137mm (5-3/8"x 5-3/8")
Miter Angle 45°	D: ø127mm (5")	H x W: 115 x 103mm (4-1/2"x 4-1/16")	H x W: 106 x 106mm (4-3/16"x 4-3/16")	S x S: 100 x 100mm (4"x 4")

D: Diameter | W: Width | H: Height | S: Side

DLW140Z 355mm (14")
RM 2,423

Cordless Portable Cut-off
Mesin Pemotong Tanpa Kord
充电式无刷轻钢架砂轮切断机



- World's First Cordless Portable Cut-off

Standard Equipment:
Cut-Off Wheel (B-64696)

- Z: Without Charger & Battery



VIDEO CLIP
Models and specs may vary by country

Wheel Diameter Diameter Mata Canai 砂轮片直径	355mm (14")
Hole Diameter Diameter Lubang 孔直径	25.4mm (1")
Max Wheel Thickness Ketebalan Roda 轮片厚度	3mm (1/8")
No Load Speed (RPM) Kelajuan Tanpa Beban 回转速	3,800
Capacity at 90° Kapasiti Pemotongan 切割能力	Round: 127mm (5") Rectangular: 115x130mm (4-1/2"x5-1/8") Rectangular: 102x194mm (4"x7-5/8") Rectangular: 70x233mm (2-3/4"x9-1/8")
Capacity at 45° Kapasiti Pemotongan 切割能力	Round: 127mm (5") Rectangular: 115x103mm (4-1/2"x4-1/16")
Dimensions (L x W x H) Dimensi 体积	537x280x640mm (21-1/8"x11"x25-1/4")
Net Weight Berat Bersih 淨重	17.2 - 17.8kg (37.9 - 39.3lbs.)
Work Amount (approx.) Jumlah Kerja 工作量	130 cuts with BL1850B x2 Metal Stud (H:75mm, W: 45mm, T: 0.8mm)

DRS780Z 185mm (7-1/4")
RM 1,905

Cordless Rear Handle Saw
Gergaji Piring Tanpa Kord
充电式后把手圆锯



- Cuts 3X Material in a Single Pass;
Blade Left Design

Standard Equipment: TCT Saw Blade (B-62022), Offset Wrench

- Z: Without Charger & Battery



Blade Diameter Diameter Bilah 锯片直径	185mm (7-1/4")
Max Cutting Capacity Kapasiti Pemotongan Maksimum 最大切割能力	90°: 65mm (2-9/16") 45°: 45mm (1-3/4") 53°: 38mm (1-1/2")
No Load Speed (RPM) Kelajuan Tanpa Beban 回转速	5,100
Dimensions (L x W x H) Dimensi 体积	446x196x270mm (17-1/2"x7-3/4"x10-5/8")
Net Weight Berat Bersih 淨重	5.0 - 5.6kg (11.1 - 12.4lbs.)

DHS710RM2J DHS710RF2J 190mm (7-1/2")
RM 2,568 RM 2,405

Cordless Circular Saw
Gergaji Piring Tanpa Kord
充电式圆锯



- Lightweight for operator comfort

Standard Equipment: TCT Saw Blade (D-09123), Rip Fence (Guide Rule), Hex Wrench

- RM2J: 1x Rapid Charger, 2x 4.0Ah Battery, 1x Makpac Connector Box
- RF2J: 1x Rapid Charger, 2x 3.0Ah Battery, 1x Makpac Connector Box



VIDEO CLIP
Models and specs may vary by country

Blade Diameter Diameter Bilah 锯片直径	190/185mm (7-1/2"/7-1/4")
Max Cutting Capacity Kapasiti Pemotongan Maksimum 最大切割能力	90°: 68.5/66mm (2-11/16"/2-5/8") 45°: 49/47.5mm (1-15/16"/1-7/8") 50°: 44/42.5mm (1-3/4"/1-11/16")
No Load Speed (RPM) Kelajuan Tanpa Beban 回转速	4,800
Dimensions (L x W x H) Dimensi 体积	356x217x298mm (14"x8-1/2"x11-3/4")
Net Weight Berat Bersih 淨重	3.9 - 4.6kg (8.6 - 10.1lbs)
Work Amount (approx.) Jumlah Kerja 工作量	205 pcs with BL1850B x2 SPF 2 x 10 (thickness 38mm, width 235mm), 90° cut

* All list price shown are for reference only (exclude SST).

* Semua harga yang ditunjukkan adalah untuk rujukan sahaja (tidak termasuk SST). 所有显示的建议零售价仅供参考 (不包括SST)。

Cordless
Tanya-tanya
LED Flashlight
Lampu Cahaya LED
Vacuum Cleaner
Penyedut Debu
Drilling / Fastening
Gergaji / Pasak
Impact Drilling / Demolition
Gergaji / Pasak
Cutting / Finishing
Pemotongan
Grinding / Sanding
Pergasi / Pasak
Sawing / Routing
Gergaji / Pasak
Planning / Routing
Pegantungan / Pasak
Others
Lain-lain
Outdoor Power Equipment
Alatan Kerja Luar





Li-ion Ah 6.0 | 5.0 | 4.0 | 3.0 | 2.0 | 1.5

Cordless Circular Saw

Gergaji Piring Tanpa Kord 充电式圆锯

Light weight

Ringan 轻量

6.0kg

with BL1860B x2
6.0Ah Battery

Variable speed control by dial

Kawalan kelajuan berubah dengan dial 拨盘变速控制



Battery capacity warning lamp

Blower function

Fungsi Peniup 吹风功能



Twin LED Job light

Lampu kerja LED LED工作灯



Bevel cuts up to 1° left and 60° right

Potongan serong 1° kiri dan 60° kanan
斜切左 1° / 右 60°



DHS900PT2 | **DHS900Z** 235mm (9-1/4")
RM 5,645 | RM 4,060

Cordless Circular Saw
Gergaji Piring Tanpa Kord
充电式圆锯



- Auto-start Wireless System (AWS) connects to vacuum cleaner with Bluetooth

Standard Equipment: TCT Saw Blade (E-01959), Sub Base, Hex Wrench

- PT2: 1x Two Port Multi Fast Charger, 2x 5.0Ah Battery
- Z: Without Charger, Battery & Carrying Case



*Not applicable for Z model

DHS782Z 190mm (7-1/2") / 185mm (7-1/4")
RM 2,943

Cordless Circular Saw
Gergaji Piring Tanpa Kord
充电式圆锯



- Overload alert using ADT lamp

Standard Equipment: TCT Saw Blade, Dust Nozzle, Hex Wrench, Guide Rule

- Z: Without Charger & Battery



DHS782 Models and specs may vary by country

DHS783Z 190mm (7-1/2") / 185mm (7-1/4")
RM 3,228

Cordless Circular Saw
Gergaji Piring Tanpa Kord
充电式圆锯



- Auto-start Wireless System (AWS) connects to vacuum cleaner with Bluetooth

Standard Equipment: TCT Saw Blade (B-62022), Hex Wrench, Guide Rule, Dust Nozzle

- Z: Without Charger & Battery



DHS783 Models and specs may vary by country

Blade Diameter Diameter Bilah 锯片直径	235mm (9-1/4")
Hole Diameter Diameter Lubang 孔直径	15.88mm (5/8") 25mm (1") 25.4mm (1") 30mm (1-3/16")
Max Cutting Capacity Kapasiti Pemotongan Maksimum 最大切割能力	90°: 85mm (3-3/8") 45°: 61mm (2-3/8") 60°: 44mm (1-3/4")
No Load Speed (RPM) Kelajuan Tanpa Beban 回转速数	4,500
Dimensions (L x W x H) Dimensi 体积	413x196x316mm (16-1/4"x7-3/4"x12-1/2")
Net Weight Berat Bersih 净重	5.3 - 6.0kg (11.7 - 13.2lbs.)

Blade Diameter Diameter Bilah 锯片直径	190mm (7 - 1/2") 185mm (7 - 1/4")
Hole Diameter Diameter Lubang 孔直径	15.88mm (5/8") 20mm (13/16") 30mm (1-3/16")
Max Cutting Capacity Kapasiti Pemotongan Maksimum 最大切割能力	90°: 62.5/ 60mm (2-7/16"/ 2-3/8") 45°: 44.5/ 43mm (1-3/4"/ 1-11/16") 48°: 42/ 41mm (1-5/8"/ 1-5/8")
No Load Speed (RPM) Kelajuan Tanpa Beban 回转速数	6,000
Max Output Keluaran Maksima 最大输出	1,800W
Dimensions (L x W x H) Dimensi 体积	348x210x290mm (13-3/4"x8-1/4"x11-3/8")
Net Weight Berat Bersih 净重	4.5 - 5.1kg (9.9 - 11.3lbs.)

Blade Diameter Diameter Bilah 锯片直径	190mm (7 - 1/2") 185mm (7 - 1/4")
Hole Diameter Diameter Lubang 孔直径	15.88mm (5/8") 20mm (13/16") 30mm (1-3/16")
Max Cutting Capacity Kapasiti Pemotongan Maksimum 最大切割能力	90°: 62.5/ 60mm (2-7/16"/ 2-3/8") 45°: 44.5/ 43mm (1-3/4"/ 1-11/16") 48°: 42/ 41mm (1-5/8"/ 1-5/8")
No Load Speed (RPM) Kelajuan Tanpa Beban 回转速数	6,000
Max Output Keluaran Maksima 最大输出	1,800W
Dimensions (L x W x H) Dimensi 体积	348x210x290mm (13-3/4"x8-1/4"x11-3/8")
Net Weight Berat Bersih 净重	4.5 - 5.1kg (9.9 - 11.3lbs.)

* All list price shown are for reference only (exclude SST).

* Semua harga yang ditunjukkan adalah untuk rujukan sahaja (tidak termasuk SST). 所有显示的建议零售价仅供参考 (不包括SST)。

Cordless Impact Driver
LED Flashlight
Vacuum Cleaner
Drilling / Fastening
Impact Drilling / Demolition
Cutting
Grinding / Sanding
Sawing
Planing / Routing
Others
Outdoor Power Equipment





Li-ion Ah 6.0 | 5.0 | 4.0 | 3.0 | 2.0 | 1.5

Battery Powered Grass Trimmer

Pemotong Rumput Berkuasa Bateri 充电式割草机

"Simple" Portable Power Supply Unit powered by multiple LXT batteries

Unit Bekalan Kuasa Mudah Alih "Mudah" yang dikuasakan oleh pelbagai bateri LXT
由多个LXT电池供电的“简单”便携式电源设备



UR201C

PDC01

TWO VARIATIONS



UR201CZ

Price TBA

Battery Powered Grass Trimmer
Pemotong Rumput Berkuasa Bateri
充电式割草机

- 1.0kW max output power similar to 30mL class engine grass trimmers

Standard Equipment: Safety Goggles, Metal Blade, Nylon Cutting Head, Plastic Blade, Blade Cover (for metal blade), Accessory Bag, Hex Wrench, Box Wrench, Band Assembly

• Z: Without Charger & Battery



Cutting Width Lebar Keratan 切割宽度	Metal Blade: 255mm (10") Nylon Cutting Head: 430mm (17") Plastic Blade: 305 mm (12")
--	--

No Load Speed (RPM) Kelajuan Tanpa Beban 回转数	Metal Blade (3/2/1): 0 - 7,000 / 0 - 5,500 / 0 - 4,600 Nylon Cutting Head (3/2/1): 0 - 5,500 / 0 - 5,000 / 0 - 4,600 Plastic Blade (305mm) (3/2/1): 0 - 7,000 / 0 - 5,500 / 0 - 4,600 Plastic Blade (255mm) (3/2/1): 0 - 5,500 / 0 - 5,000 / 0 - 4,600
--	---

Spindle Size Saiz Spindel 主轴尺寸	M10 x 1.25LH
--	--------------

Dimensions (L x W x H) Dimensi 体积	1,795x400x269mm (70-1/2"x15-3/4"x10-5/8")
---	--

Net Weight Berat Bersih 净重	4.7kg (10.4lbs.)
--------------------------------------	------------------

DUR369LZ

Price TBA

Cordless Grass Trimmer
Pemotong Rumput Tanpa Kord
充电式割草机

- 1.0kW max output power similar to 30mL class engine grass trimmers

Standard Equipment: Safety Goggles, Metal Blade / Nylon Cutting Head / Plastic Blade (country-specific), Blade cover (for the product with metal blade), Accessory Bag, Hex Wrench, Box Wrench, Shoulder Belt

• Z: Without Charger & Battery



Cutting Width Lebar Keratan 切割宽度	Metal Blade: 255mm (10") Nylon Cutting Head: 430mm (17") Plastic Blade: 305 mm (12")
--	--

No Load Speed (RPM) Kelajuan Tanpa Beban 回转数	Metal Blade (3/2/1): 0 - 7,000 / 0 - 5,500 / 0 - 4,600 Nylon Cutting Head (3/2/1): 0 - 5,500 / 0 - 5,000 / 0 - 4,600 Plastic Blade (305 mm) (3/2/1): 0 - 7,000 / 0 - 5,500 / 0 - 4,600 Plastic Blade (255 mm) (3/2/1): 0 - 5,500 / 0 - 5,000 / 0 - 4,600
--	---

Spindle Size Saiz Spindel 主轴尺寸	M10 x 1.25LH
--	--------------

Dimensions (L x W x H) Dimensi 体积	1,846x400x269mm (72-1/2"x15-3/4"x10-5/8")
---	--

Net Weight Berat Bersih 净重	5.7 - 6.3kg (12.6 - 13.9lbs.)
--------------------------------------	-------------------------------

DUR364LPM4

RM 4,118

DUR364LRM2

RM 3,015

DUR364LZ

RM 1,877

Cordless Grass Trimmer
Pemotong Rumput Tanpa Kord
充电式割草机

- 2-Speed options allows the operator to match speed to application

Standard Equipment: Safety Goggles (195246-2), Nylon Cutting Head, Accessory Bag, Hex Wrench

- PM4: 1x Two Port Multi Fast Charger, 4x 4.0Ah Battery
- RM2: 1x Rapid Charger, 2x 4.0Ah Battery
- Z: Without Charger & Battery



Cutting Width Lebar Keratan 切割宽度	Trimmer Head: 350mm (13-3/4") Plastic Blade: 255mm (10")
--	---

No Load Speed (RPM) Kelajuan Tanpa Beban 回转数	High: 6,500 Low: 5,000
--	--------------------------

Spindle Size Saiz Spindel 主轴尺寸	M8 x 1.25RH
--	-------------

Dimensions (L x W x H) Dimensi 体积	1,754x310x229mm (69"x12-1/4"x9")
---	-------------------------------------

Net Weight Keberatan 净重	3.6 - 4.4kg (8.0 - 9.7lbs)
-----------------------------------	----------------------------

Continuous Usage Time (approx.) Masa Penggunaan Berterusan 连续使用时间	Low: 490min Mid: 221min High: 149min with BL1850B x2
---	--

* All list price shown are for reference only (exclude SST).

* Semua harga yang ditunjukkan adalah untuk rujukan sahaja (tidak termasuk SST). 所有显示的建议零售价仅供参考 (不包括SST)。

Cordless
Tanpa Kord Tanpa Kord

LED Flashlight
Lampu Cahaya LED
LED照明灯

Vacuum Cleaner
Penyedut Vakuum
吸尘器

Drilling / Fastening
Gredil / Pengikat
电钻 / 螺絲

Impact Drilling / Demolition
Gredil / Pencah
冲击电钻 / 拆墙机

Cutting
Pemotong
切割

Grinding / Sanding
Pergasil / Pasah
磨刀 / 磨光

Sawing
Gajuh
锯切

Planing / Routing
Pegayaan / Tangan
刨平 / 开槽

Others
Lain-lain
其他

Outdoor Power Equipment
Alatan Kuasa Luar
户外动力设备





Li-ion Ah 6.0 5.0 4.0 3.0 2.0 1.5

DUR368APT2 | DUR368AZ
RM 4,513 | RM 2,927

Cordless Grass Trimmer
Pemotong Rumput Tanpa Kord
充电式割草机



- Lightweight for reduced operator fatigue

Standard Equipment: Safety Goggles (195246-2), Plastic Blade, Accessory Bag, Hex Wrench, Band Assembly

- PT2: 1x Two Port Multi Fast Charger, 2x 5.0Ah Battery
- Z: Without Charger & Battery



Cutting Width Lebar Keratan 切割宽度	Metal Blade: 255mm (10") Trimmer Head: 350mm (13-3/4") Plastic Blade: 255mm (10")
--	--

No Load Speed (RPM) Kelajuan Tanpa Beban 回转数	High: 6,500 Med: 5,300 Low: 3,500
Spindle Size Saiz Spindel 主轴尺寸	M10 x 1.25LH

Dimensions (L x W x H) Dimensi 体积	1,758x615x442mm (69-1/4"x24-1/4"x17-3/8")
Net Weight Berat Bersih 净重	4.1 - 4.7kg (9.0 - 10.5lbs.)

Continuous Usage Time (approx.) Masa Penggunaan Berterusan 连续使用时间	104min Low Speed with BL1850B x2
---	---

DUR368LPT2 | DUR368LZ
RM 4,190 | RM 2,605

Cordless Grass Trimmer
Pemotong Rumput Tanpa Kord
充电式割草机

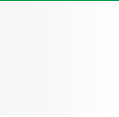

- Lightweight for reduced operator fatigue

Standard Equipment: Safety Goggles (195246-2), Plastic Blade, Accessory Bag, Hex Wrench, Band Assembly

- PT2: 1x Two Port Multi Fast Charger, 2x 5.0Ah Battery
- Z: Without Charger & Battery



Cutting Width Lebar Keratan 切割宽度	Metal Blade: 255mm (10") Trimmer Head: 350mm (13-3/4") Plastic Blade: 255mm (10")
--	--

No Load Speed (RPM) Kelajuan Tanpa Beban 回转数	High: 6,500 Med: 5,300 Low: 3,500
Spindle Size Saiz Spindel 主轴尺寸	M10 x 1.25LH

Dimensions (L x W x H) Dimensi 体积	1,758x362x231mm (69-1/4"x14-1/4"x9-1/8")
Net Weight Berat Bersih 净重	3.9 - 4.5kg (8.6 - 10.0lbs.)

Continuous Usage Time (approx.) Masa Penggunaan Berterusan 连续使用时间	90min Low Speed with BL1850B x2
---	--

DUP361Z
RM 6,630

Battery Powered Pruning Shears
Gunting Pemangkas Bateri
充电式电剪



- Extra sharp, Made-in-Japan forged blade

Standard Equipment: Oil Supply, Wrench Set, Diamond File, Cord Holder, Holster, Harness, Arm Band, Tool Bag, Shear Blade

- Z: Without Charger & Battery



VIDEO CLIP
Models and specs may vary by country



Max Output Keluaran Maksima 最大输出	200W
--	-------------

Capacity Kapasiti 能力	Max Cutting : 33mm
--------------------------------	---------------------------

Dimensions (L x W x H) Dimensi 体积	Max Blade Opening: 54mm 305x43x106mm (12"x1-11/16"x4-3/16")
---	--

Net Weight Keberatan 净重	0.8kg (1.8lbs)
-----------------------------------	-----------------------

Work Amount (approx.) Jumlah Kerja 工作量	71,000cuts with BL1850B x2 (15mm Grape Wine Branch)
--	--

DUP362ZN
RM 7,523

Battery Powered Pruning Shears
Gunting Pemangkas Bateri
充电式电剪



- Extra sharp, Made-in-Japan forged blade

Standard Equipment: Oil Supply, Wrench Set, Diamond File, Cord Holder, Holster, Harness, Arm Band, Tool Bag, Shear Blade

- Z: Without Charger & Battery



VIDEO CLIP
Models and specs may vary by country



Max Output Keluaran Maksima 最大输出	200W
--	-------------

Capacity Kapasiti 能力	Max Cutting : 33mm (1-5/16")
--------------------------------	-------------------------------------

Dimensions (L x W x H) Dimensi 体积	Max Blade Opening: 54mm 305x43x106mm (12"x1-11/16"x4-3/16")
---	--

Net Weight Keberatan 净重	0.77 - 0.82kg (1.7 - 1.8lbs.)
-----------------------------------	--------------------------------------

Work Amount (approx.) Jumlah Kerja 工作量	71,000cuts with BL1850B x2 (15mm Grape Wine Branch)
--	--



* All list price shown are for reference only (exclude SST).

* Semua harga yang ditunjukkan adalah untuk rujukan sahaja (tidak termasuk SST). 所有显示的建议零售价仅供参考 (不包括SST)。

Cordless
Tanpa Kord / 充电式

LED Flashlight
Lampu Suluh LED
LED照明灯

Vacuum Cleaner
Penyedut Vakuum
吸尘器

Drilling / Fastening
Draib / Pengikat
钻孔 / 紧固

Impact Drilling / Demolition
Draib / Pemusnah
冲击钻孔 / 拆除

Cutting
Pemotong
切割

Grinding / Sanding
Pengkilan / Pemoles
磨削 / 打磨

Sawing
Gergaji
锯切

Planing / Routing
Pegangan / Pengamiran
刨削 / 铣削

Others
Lain-lain
其他

Outdoor Power Equipment
Alatan Kuasa Luar
户外动力设备

Makita
MAKITA



Li-ion Ah 6.0 5.0 4.0 3.0 2.0 1.5

Cordless Lawn Mower

Mesin Pemotong Rumput Tanpa Kord 充电式手推割草机

Recommended mowing area
Julat memotong yang disyorkan 推荐的割草范围

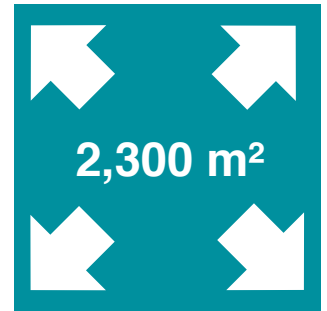

DLM532 with BL1860B x4



Grass level indicator
Penunjuk tahap rumput 草地高度指示器



empty

full

4 battery slots
4 slot bateri 4个电池插槽



Child lock key
Kunci kanak-kanak 儿童锁

Heavy duty handle
Pemegang tugas berat 重型手柄

Steel Deck
Dek Keluli 钢板

Built-in ball bearing on axles for added durability
Gelas bebola terbina dalam pada gandar untuk ketahanan tambahan
车轴上内置滚珠轴承, 增加了耐用性



DLM532Z 534mm (21")
RM 6,563

Cordless Lawn Mower
Mesin Pemotong Rumput Tanpa Kord
充电式手推割草机



• IPX4 water resistant for use in bad weather

NEW BARU 新



Standard Equipment: Blade, Mulch plug, Side Discharge Mouth, Socket Wrench, Rod

• Z: Without Charger & Battery



Blade Hole Diameter Diameter lubang bilah 叶片孔直径	10.0mm (3/8")
Cutting Width Lebar Keratan 切割宽度	534mm (21")
Cutting Height Ketinggian Pemotongan 切割高度	20 - 100mm (13/16" - 3-15/16")
Grass box capacity Kapasiti Kotak Rumput 草箱容量	60L
No Load Speed (RPM) Kelajuan Tanpa Beban 回转速	2,300 - 2,800
Wheel Size Saiz Roda 轮片尺寸	Front / Rear: 230mm (9")
Dimensions (L x W x H) Dimensi 体积	1,630-1,715x590x990-1,095mm (64"-67-1/2"x23-1/4"x39"-43")
Net Weight Berat Bersih 净重	39.0 - 42.8kg (86.0 - 94.4lbs.)
Continuous Usage Time (approx.) Masa Penggunaan Berterusan 连续使用时间	33min (self-propelled) 45min (push-drive) with BL1850B x2

* All list price shown are for reference only (exclude SST).

* Semua harga yang ditunjukkan adalah untuk rujukan sahaja (tidak termasuk SST). 所有显示的建议零售价仅供参考 (不包括SST)。

- Cordless
Tangkas Tanpa Kord
- LED Flashlight
Lampu Cahaya LED
LED照明灯
- Vacuum Cleaner
Penyedut Vakuum
吸尘器
- Drilling / Fastening
Ganda / Pasang
钻孔 / 紧固
- Impact Drilling / Demolition
Ganda / Hancurkan
冲击钻孔 / 拆除
- Cutting
Pemotong
切割
- Grinding / Sanding
Pergasi / Rata
磨削 / 打磨
- Sawing
Gugut
锯切
- Planing / Routing
Pegasi / Tangkapan
刨平 / 截割
- Others
Lain-lain
其他
- Outdoor Power Equipment
Alatan Kuasa Luar
户外动力设备





Li-ion Ah 6.0 5.0 4.0 3.0 2.0 1.5

DLM382PT2 | DLM382Z 380mm (15")
Price TBA | Price TBA

Cordless Lawn Mower
Mesin Pemotong Rumput
Tanpa Kord
充电式手推割草机



- Zero emissions and reduced maintenance; no need for gas or oil

Standard Equipment: Blade, Mulch Plug, Socket Wrench

- Z: Without Charger & Battery



Cutting Width Lebar Keratan 切割宽度	380mm (15")
Cutting Height Ketinggian Pemotongan 切割高度	20 - 75mm (13/16" - 2-15/16")
Grass box capacity Kapasiti Kotak Rumput 草箱容量	40L
No Load Speed (RPM) Kelajuan Tanpa Beban 回转速数	3,700
Wheel Size Saiz Roda 轮片尺寸	Front: 140mm (5-1/2") Rear: 160mm (6-5/16")
Dimensions (L x W x H) Dimensi 体积	1,380-1,410x450x985-1,005mm (54-1/4"-55-1/2"x17-3/4"x38-3/4"-39-1/2")
Net Weight Berat Bersih 净重	16.2 - 16.9 kg (35.7 - 37.3 lbs.)
Continuous Usage Time (approx.) Masa Penggunaan Berterusan 连续使用时间	35 min with BL1860B x2

DLM432PT2 | DLM432Z 430mm (17")
Price TBA | Price TBA

Cordless Lawn Mower
Mesin Pemotong Rumput
Tanpa Kord
充电式手推割草机



- Low noise level suitable for use in residential areas and public spaces

Standard Equipment: Blade, Mulch Plug, Socket Wrench

- Z: Without Charger & Battery



Cutting Width Lebar Keratan 切割宽度	430mm (17")
Cutting Height Ketinggian Pemotongan 切割高度	20 - 75mm (13/16" - 2-15/16")
Grass box capacity Kapasiti Kotak Rumput 草箱容量	50L
No Load Speed (RPM) Kelajuan Tanpa Beban 回转速数	3,600
Wheel Size Saiz Roda 轮片尺寸	Front: 140mm (5-1/2") Rear: 160mm (6-5/16")
Dimensions (L x W x H) Dimensi 体积	1,435-1,490x460x1,005-1,045mm (56-1/2"-58-3/4"x18-1/8"x39-1/2"-41-1/4")
Net Weight Berat Bersih 净重	16.8 - 17.5kg (37.0 - 38.6lbs.)
Continuous Usage Time (approx.) Masa Penggunaan Berterusan 连续使用时间	36 min with BL1860B x2

DLM460Z 460mm (18")
RM 3,743

Cordless Lawn Mower
Mesin Pemotong Rumput
Tanpa Kord
充电式手推割草机



- IPX4 water resistant for use in bad weather

Standard Equipment: Blade, Socket Wrench

- Z: Without Charger & Battery



Blade Type Jenis Bilah 刀片类型	2 Tooth
Cutting Width Lebar Keratan 切割宽度	460mm (18")
Cutting Height Ketinggian Pemotongan 切割高度	20 - 75mm (13/16" - 2-5/16")
Grass Box Capacity Kapasiti Kotak Rumput 草箱容量	60L
No Load Speed (RPM) Kelajuan Tanpa Beban 回转速数	2,500 - 3,300
Recommended Mowing Area Julat Memotong Yang Disyorkan 推荐的割草范围	With BL1850B x2: 680 - 1,360m ²
Wheel Size Saiz Roda 轮片尺寸	Front: 180mm (7") Rear: 205mm (8")
Max Output Keluaran Maksima 最大输出	1,450W
Dimensions (L x W x H) Dimensi 体积	During operation: 1,319-1,518 x 532 x 879-1,138mm (52"-59-3/4" x 21" x 34-1/2"-44-3/4")
Net Weight Berat Bersih 净重	25.3 - 27.6kg (55.8 - 60.8lbs.)
Continuous Usage Time (approx.) Masa Penggunaan Berterusan 连续使用时间	18min with BL1850B x2

DLM431PT2 | DLM431Z 430mm (17")
RM 4,457 | RM 2,872

Cordless Lawn Mower
Mesin Pemotong Rumput
Tanpa Kord
充电式手推割草机



- Large 50L capacity grass basket reduces the need for emptying

Standard Equipment: Blade, Socket Wrench

- PT2: 1x Two Port Multi Fast Charger, 2x 5.0Ah Battery
- Z: Without Charger & Battery



Blade Type Jenis Bilah 刀片类型	2 Tooth, Rotary Type
Cutting Width Lebar Keratan 切割宽度	430mm (17")
Cutting Height Ketinggian Pemotongan 切割高度	20 - 75mm (13/16" - 2-15/16")
Grass Box Capacity Kapasiti Kotak Rumput 草箱容量	50L
No Load Speed (RPM) Kelajuan Tanpa Beban 回转速数	3,600
Recommended Mowing Area Julat Memotong Yang Disyorkan 推荐的割草范围	With BL1850B x2: 475 - 950m ²
Wheel Size Saiz Roda 轮片尺寸	Front: 140mm (5 - 1/2") Rear: 160mm (6 - 5/16")
Dimensions (L x W x H) Dimensi 体积	1,450-1,490x460x950-1,020mm (57-5/8"x18-1/8"x37-1/2"-40-1/4")
Net Weight Keberatan 净重	17.8 - 18.4kg (39.2 - 40.6lbs)
Continuous Usage Time (approx.) Masa Penggunaan Berterusan 连续使用时间	30min with BL1850B x2

DLM380Z 380mm (15")
RM 2,290

Cordless Lawn Mower
Mesin Pemotong Rumput
Tanpa Kord
充电式手推割草机



- Zero emissions and reduced maintenance

Standard Equipment: Blade, Wrench

- Z: Without Charger & Battery



Blade Type Jenis Bilah 刀片类型	2 Tooth, Rotary Type
Cutting Width Lebar Keratan 切割宽度	380mm (15")
Cutting Height Ketinggian Pemotongan 切割高度	25 - 75mm (1" - 2-15/16")
Grass Box Capacity Kapasiti Kotak Rumput 草箱容量	40L
No Load Speed (RPM) Kelajuan Tanpa Beban 回转速数	3,700
Recommended Mowing Area Julat Memotong Yang Disyorkan 推荐的割草范围	With BL1830B x2: 270 - 540m ²
Wheel Size Saiz Roda 轮片尺寸	Front: 140mm (5 - 1/2") Rear: 190mm (7 - 1/2")
Dimensions (L x W x H) Dimensi 体积	1,145x465x1,023-1,070mm (45"x18-1/4"x40-1/4"-42")
Net Weight Keberatan 净重	14.5kg (32.0lbs)
Continuous Usage Time (approx.) Masa Penggunaan Berterusan 连续使用时间	30min with BL1850B x2

* All list price shown are for reference only (exclude SST).

* Semua harga yang ditunjukkan adalah untuk rujukan sahaja (tidak termasuk SST). 所有显示的建议零售价仅供参考 (不包括SST)。

Cordless
Tanpa Kord 充电式

LED Flashlight
Lampu Suluh LED
LED 闪光灯

Vacuum Cleaner
Penyedut Vakum
吸尘器

Drilling / Fastening
Draib / Pasang
电钻 / 紧固件

Impact Drilling / Demolition
Draib Dampak / Hancurkan
电钻 / 电锤

Cutting
Memotong
切割

Grinding / Sanding
Menggosok / Mengkilap
打磨 / 抛光

Sawing
Gergaji
电锯

Planing / Routing
Mencanak / Mengukir
刨花 / 雕刻

Others
Lain-lain
其他

Outdoor Power Equipment
Alatan Kuasa Luar
户外动力设备

Makita
Makita



Li-ion Ah 6.0 5.0 4.0 3.0 2.0 1.5

Cordless Chain Saw

Gergaji Rantai Tanpa Kord 充电式链锯



Jumlah Kerja 工作量
Work Amount
 with BL1850B x2
 (50mm Timber)
500cuts
 (approx.)

* Continuous Usage Time/ Work Amount:
 Actual performance may vary based on application.
 Masa Penggunaan Berterusan/ Jumlah Kerja: Prestasi sebenar
 mungkin berbeza berdasarkan aplikasi.
 连续使用时间/ 工作量: 实际性能可能因应用而异。



Net weight
 Berat Bersih 净重
4.6kg
 with BL1850B x2
 5.0Ah Battery

DUC406Z 400mm (16") RM 3,160

Cordless Chain Saw
 Gergaji Rantai Tanpa Kord
 充电式链锯



- Low noise level and zero emissions for operator comfort

Standard Equipment: Saw Chain, Guide Bar, Guide Bar Cover, Chain Oil, Socket Wrench

• Z: Without Charger & Battery



Guide Bar Length Panjang Batang Gergaji 切割长度	400mm (16")
Cutting Length Panjang Pemotongan 切割长度	387mm (15-1/4")
Chain Pitch Kerapatan Rantai 链条齿距	3/8"
Chain Gauge Ketebalan Rantai 链条厚度	1.3mm (0.05")
Chain Speed Kelajuan Rantai 链条速度	0 - 20m/s (0 - 1,200 m/min) (0 - 3,940 FPM)
Chain Oil Tank Volume Tangki Minyak Pelincir 链油箱	200mL (6.8 US oz)
Dimensions (L x W x H) Dimensi 体积	270-651x205x232mm (10-5/8"-25-5/8"x8-1/8"x9-1/8")
Net Weight Berat Bersih 净重	5.1kg (11.1lbs.)
Work Amount (approx.) Jumlah Kerja 工作量	500cuts with BL1850B x2 (50mm timber)

DUC356Z 350mm (14") RM 2,162

Cordless Chain Saw
 Gergaji Rantai Tanpa Kord
 充电式链锯



- Low noise level and zero emissions for operator comfort

Standard Equipment: Saw Chain, Guide Bar, Guide Bar Cover, Spike Bumper, Chain Oil, Socket Wrench

• Z: Without Charger & Battery



Guide Bar Length Panjang Batang Gergaji 切割长度	350mm (14")
Cutting Length Panjang Pemotongan 切割长度	350mm (14")
Chain Pitch Kerapatan Rantai 链条齿距	9.5mm (3/8")
Chain Gauge Ketebalan Rantai 链条厚度	1.1(0.043") or 1.3mm (0.050")
Chain Speed Kelajuan Rantai 链条速度	0 - 20m/s (0 - 1,200 m/min) (0 - 3,940 FPM)
Chain Oil Tank Volume Tangki Minyak Pelincir 链油箱	200mL (6.8 US oz)
Dimensions (L x W x H) Dimensi 体积	270-651x205x232mm (10-5/8"-25-5/8"x8-1/8"x9-1/8")
Net Weight Berat Bersih 净重	5.1kg (11.1lbs.)
Work Amount (approx.) Jumlah Kerja 工作量	500cuts with BL1850B x2 (50mm timber)

DUC355Z 350mm (14") RM 2,048

Cordless Chain Saw
 Gergaji Rantai Tanpa Kord
 充电式链锯



- Constant speed control maintains constant speed under heavy load

Standard Equipment: Saw Chain, Guide Bar, Guide Bar Cover, Chain Oil, Socket Wrench

• Z: Without Charger & Battery



Guide Bar Length Panjang Batang Gergaji 切割长度	350mm (14")
Chain Pitch Kerapatan Rantai 链条齿距	3/8"
Chain Gauge Ketebalan Rantai 链条厚度	1.1mm (0.043")
Chain Speed Kelajuan Rantai 链条速度	0 - 20m/s (0 - 1,200m/min) (0 - 3,940 FPM)
Chain Oil Tank Volume Tangki Minyak Pelincir 链油箱	200mL (N/A US oz)
Dimensions (L x W x H) Dimensi 体积	762x211x235mm (30"x8-5/16"x9-1/4")
Net weight Berat Bersih 净重	4.7 - 5.4kg (10.4 - 11.8lbs.)
Work Amount (approx.) Jumlah Kerja 工作量	550cuts with BL1850B x2 (50mm timber)

* All list price shown are for reference only (exclude SST).

* Semua harga yang ditunjukkan adalah untuk rujukan sahaja (tidak termasuk SST). 所有显示的建议零售价仅供参考 (不包括SST)。

Cordless
Tangki Minyak Pelincir

LED Flashlight
Lampu Sinar LED
LEO1850B1

Vacuum Cleaner
Penyedut Vakuum
VLS1850

Drilling / Fastening
Gergaji / Pengikat
MST1 / MST2

Impact Drilling / Demolition
Gergaji / Pencahul
MST1 / MST2 / MDT1850

Cutting
Pemotong
CST1

Grinding / Sanding
Pergasi / Pemoles
GRT1 / GRT2

Sawing
Gergaji
GST1

Planing / Routing
Pegulasan / Tonggolan
GRT1 / GRT2

Others
Lain-lain
MST1

Outdoor Power Equipment
Alatan Kerja Luar
MST1



Li-ion Ah 6.0 5.0 4.0 3.0 2.0 1.5

DUC353Z 350mm (14")
RM 2,237

Cordless Chain Saw
Gergaji Rantai Tanpa Kord
充电式链锯



- Cordless Chain Saw DUC353 Efficiency Similar to 30ml Class Engine Chain Saw

Standard Equipment: Saw Chain, Guide Bar, Guide Bar Cover, Chain Oil

- Z: Without Charger & Battery



Guide Bar Length Panjang Batang Gergaji 切割长度	350mm (14")
Chain Pitch Kerapatan Rantai 链条齿距	9.5mm (3/8")
Chain Gauge Ketebalan Rantai 链条厚度	1.1/ 1.3mm (0.043" / 0.050")
Chain Speed Kelajuan Rantai 链条速度	0 - 20m/s (0 - 1,200m/min) (0 - 3,940FPM)
Chain Oil Tank Volume Tangki Minyak Pelincir 链油箱	200mL (N/A US oz)
Dimensions (L x W x H) Dimensi 体积	773x215x235mm (30-1/2"x8-1/2"x9-1/4")
Net Weight Keberatan 净重	4.7kg (10.4 lbs)
Work Amount (approx.) Jumlah Kerja 工作量	550cuts with BL1850B x2 (50mm timber)

DUC252PM4 | **DUC252Z** 250mm (10")
RM 4,275 | RM 2,032

Cordless Chain Saw
Gergaji Rantai Tanpa Kord
充电式链锯



- Low noise level and zero emissions for operator comfort

Standard Equipment: Saw Chain, Guide Bar, Guide Bar Cover, Spike Bumper

- PM4: 1 x Two Port Multi Rapid Charger, 4 x 4.0Ah Battery, 1x Tool Bag
- Z: Without Charger & Battery



Guide Bar Length Panjang Batang Gergaji 切割长度	250mm (10")
Chain Pitch Kerapatan Rantai 链条齿距	3/8"
Chain Gauge Ketebalan Rantai 链条厚度	1.3mm (0.05")
Chain Speed Kelajuan Rantai 链条速度	8.3m/s (500m/min) (1,650FPM)
Chain Oil Tank Volume Tangki Minyak Pelincir 链油箱	85mL (2.9US oz)
Dimensions (L x W x H) Dimensi 体积	545x234x198mm (21-1/2"x9-1/4"x7-3/4")
Net Weight Keberatan 净重	4.1 - 4.7kg (9.0 - 10.3lbs)
Work Amount (approx.) Jumlah Kerja 工作量	560cuts with BL1850B x2 (50mm timber)

Cordless Multi Function Power Head

Powerhead Pelbagai Fungsi Tanpa Kord
充电式多功能动力头



DUX60ZM3 | **DUX60Z**
RM 2,488 | RM 1,973

Cordless Multi Function Power Head
Powerhead Pelbagai Fungsi Tanpa Kord | 充电式多功能动力头



- Multi-tool system consisting of power head and versatile optional attachments is ideal for a wide range of applications

Standard Equipment: Band Assembly, Hex Wrench, Accessory Bag
DUX60ZM3: Brushcutter Attachment EM403, Nylon Cutting Head, 3 Tooth Blade, 3 Tooth Blade Cover, Tool Bag, Box Wrench 17, Metal Blade Fixing Tool (Clamp Washer, Nut, Cup)

- Z: Without Charger & Battery • ZM3: Without Charger & Battery



No Load Speed (RPM) Kelajuan Tanpa Beban 回转速	High: 0 - 9,700/ Medium: 0 - 8,200 Low: 0 - 5,700
Dimensions (L x W x H) Dimensi 体积	1,011x320x216mm (39-3/4"x12-5/8"x8-1/2")
Net Weight Berat Bersih 净重	4.1 - 8.7kg (8.9 - 19.2lbs)
Continuous Usage Time (approx.) Masa Penggunaan Berterusan 连续使用时间	Low: 97min Mid: 35min High: 21min with BL1850B x2 (Grass Trimmer)

DUH651Z 650mm (25-1/2")
RM 1,903

Cordless Hedge Trimmer
Pemangkas Tanaman Pagar
Tanpa Kord
充电式篱笆修剪机



- 5-Position rotating rear handle for increased comfort during vertical and angle trimming

Standard Equipment: Blade Cover

- Z: Without Charger & Battery



Blade Length Panjang bilah 刀片长度	650mm (25-1/2")
Strokes Per Minute (SPM) Kelajuan Strok 冲程速度	2,000 - 3,600
Tooth Spacing Selang Gigi 牙齿间隔	36mm (1-7/16")
Dimensions (L x W x H) Dimensi 体积	1,135x225x200mm (44-3/4"x8-7/8"x7-7/8")
Net Weight Keberatan 净重	4.7 - 5.5kg (10.3 - 12.0lbs)
Continuous Usage Time (approx.) Masa Penggunaan Berterusan 连续使用时间	75 - 125min with BL1850B x2

* All list price shown are for reference only (exclude SST).

* Semua harga yang ditunjukkan adalah untuk rujukan sahaja (tidak termasuk SST). 所有显示的建议零售价仅供参考 (不包括SST)。

Cordless Impact Driver
LED Flashlight
Vacuum Cleaner
Drilling / Fastening
Impact Drilling / Demolition
Cutting
Grinding / Sanding
Sawing
Planing / Routing
Others
Outdoor Power Equipment





Li-ion Ah 6.0 5.0 4.0 3.0 2.0 1.5

Cordless Blower

Mesin Peniup Tanpa Kord 充电式吹风机



2 Power modes
 Mode 1: Low
 Mode 2: High
 2 Mod kuasa
 2种电源模式

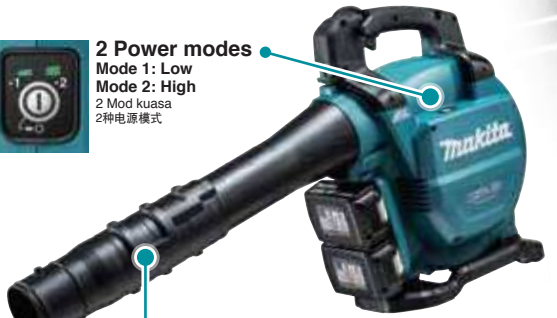

3-stage telescopic long nozzle with an adjustment range of 100mm (4")
 Teleskopik 3-peringkat panjang muncung dengan pelarasan 100mm (4")
 三级伸缩长喷嘴, 调节范围为100mm (4")

72mm diameter nozzle
 DUB362's extension nozzle and flat nozzle can be connected without adapter
 Muncung diameter 72mm nozzle penyambung dan muncung rata DUB362 boleh disambungkan tanpa penyambung
 直径72mm的喷嘴, DUB362的加长喷嘴和扁平喷嘴可在不使用适配器的情况下进行连接



Sub handle makes it easier to hold the machine sideways both in blower and vacuum applications
 Pemegang bawah mudah untuk memegang mesin menadkat kedua-dua dalam aplikasi blower dan vakum
 手柄在鼓风机和真空应用中更容易将机器侧向固定

Dust Bag Capacity
 Kapasiti beg debu
 尘埃容量
50L

DUB363ZV

Price TBA

Cordless Blower
 Mesin Peniup Tanpa Kord
 充电式吹风机



- Able to use both in Blower and Vacuuming applications

Standard Equipment: Vacuum Kit, Flat Nozzle, End Nozzle, Pipe, Band Assembly, Hex Wrench

• Z: Without Charger & Battery



Max Air Volume Isipadu Angin Maksimum 最大风量	13.4m³/min (473 CFM)
Max Air Velocity Velositi Angin Maksimum 最大风速	65m/s
No Load Speed (RPM) Kelajuan Tanpa Beban 回转数	0 - 7,850
Dimensions (L x W x H) Dimensi 体积	737/786/836x193x415mm (7-7/16"/31"/33"x7-5/8"x16-3/8")
Net Weight Berat Bersih 净重	4.5 - 6.6kg (9.9 - 14.6lbs.)

DUB362RM2 | DUB362Z

RM 3,432

RM 2,292

Cordless Blower
 Mesin Peniup Tanpa Kord
 充电式吹风机



- 6-stage air velocity/volume selection dial with variable speed control trigger

Standard Equipment: Nozzle

• RM2: 1x Rapid Charger, 2x 4.0Ah Battery
 • Z: Without Charger & Battery



Max Air Volume Isipadu Angin Maksimum 最大风量	13.4m³/min (473CFM)
Max Air Velocity Velositi Angin Maksimum 最大风速	54m/s (120MPH)
No Load Speed (RPM) Kelajuan Tanpa Beban 回转数	11,400 - 21,500
Dimensions (L x W x H) Dimensi 体积	830/880/930x205x295mm (32-3/4"/34-3/4"/36-5/8"x8-1/8"x11-5/8")
Net Weight Berat Bersih 净重	3.5kg (7.7lbs)
Continuous Usage Time (approx.) Masa Penggunaan Berterusan 连续使用时间	75 With BL1850B x2 (Speed 1)

DUB361Z

RM 1,092

430

Cordless Blower
 Mesin Peniup Tanpa Kord
 充电式吹风机



- Long blowing nozzle with curved tip for optimal blowing performance

Standard Equipment: Shoulder Belt, Nozzle

• Z: Without Charger & Battery



Max Air Volume Isipadu Angin Maksimum 最大风量	High: 4.4m³/min (155CFM) Low: 2.6m³/min (92CFM)
Max Air Velocity Velositi Angin Maksimum 最大风速	High: 93m/s (208MPH) Low: 57m/s (128MPH)
No Load Speed (RPM) Kelajuan Tanpa Beban 回转数	High: 17,000 Low: 10,000
Dimensions (L x W x H) Dimensi 体积	905x141x194mm (35-5/8"x5-5/8"x7-5/8")
Net Weight Berat Bersih 净重	2.6kg (5.9lbs)
Continuous Usage Time (approx.) Masa Penggunaan Berterusan 连续使用时间	Low: 92min High: 30min with BL1850B x2

* All list price shown are for reference only (exclude SST).

* Semua harga yang ditunjukkan adalah untuk rujukan sahaja (tidak termasuk SST). 所有显示的建议零售价仅供参考 (不包括SST)。

- Cordless Targeted Blower
- LED Flashlight Lampu Cahaya LED LED LIGHT
- Vacuum Cleaner Penapisan Vakuum VACUUM
- Drilling / Fastening Gredil / Pasak Drill / Screws
- Impact Drilling / Demolition Gredil / Pasak Impact Drill / Demolition
- Cutting Pemotong CUTTER
- Grinding / Sanding Pengisar / Rata GRINDER / SANDER
- Sawing Gergaji SAW
- Planing / Routing Penghalus / Tumpang PLANER / ROUTER
- Others Lain-lain OTHERS
- Outdoor Power Equipment Alatan Kuat Ukir OUTDOOR POWER EQUIPMENT





Li-ion Ah 6.0 5.0 4.0 3.0 2.0 1.5

Cordless High Pressure Washer

Pembersih Tekanan Tinggi Tanpa Kord 充电式高压清洗机

Accessories (Optional)

Aksesori 配件

Cyclone jet nozzle set (Optional)
Part No. 197824-4

Trigger gun set
Part No. 197842-2

High pressure extension hose (Optional)
Part No.
5m 197845-6
8m 197847-2
10m 197850-3

Cyclone guard set (Optional)
Part No. 197864-2

Extension pipe set (Optional)
Part No. 197870-7

High pressure hose (Optional)
Part No.
5m 126766-5 (PVC)
10m 123784-4 (PVC)
10m 123651-3 (Rubber)

Variospray lance set (Optional)
Part No. 197876-5

Twist prevention joint set (Optional)
Part No. 197867-6

Trolley (Optional)
Part No. TR00000002
able to stack on for easy loading

Foam nozzle set (Optional)
Part No. 197886-2

Wash brush set (Optional)
Part No. 197828-6

Variable nozzle set
Part No. 197822-8

Rotating brush set (Optional)
Part No. 197831-7

Under body spray lance set (Optional)
Part No. 197859-5

Absorption connector set (Optional)
Part No. 197881-2

One touch joint set
Part No. 197883-8

Pipe cleaning hose (Optional)
Part No.
10m 197837-5
15m 197840-6

Self-suction hose set
Part No. 197873-1

Accessory joint set (Optional)
Part No. 197853-7

DHW080ZK RM 3,463

Cordless High Pressure Washer
Pembersih Tekanan Tinggi Tanpa Kord
充电式高压清洗机

- High/ Low 2-pressure selection

Standard Equipment: Trigger Gun, High Pressure Hose 5m, Suction Hose, Cleaner Pin, Storage Box, Variable Nozzle, Connector, One Touch Joint

- Z: Without Charger & Battery



Max Permissible Pressure Tekanan Maksimum 最大水压	8.0MPa
Regular Pressure Tekanan Tetap 固定压力	High: 5.5MPa Low: 3.0MPa
Max Water Flow Aliran Air Maksimum 最大水流量	380L/h (6.3L/min)
Regular Flow Aliran Air Tetap 固定水流量	High: 330L/h (5.5L/min) Low: 240L/h (4.0L/min)
Pump Speed (RPM) Kelajuan Pam 水泵速度	High: 3,450 Low: 2,390
Max Feed Temperature Suhu Maksimum 最高温度	40°C
Tank Kapasiti 容量	50L
Dimensions (L x W x H) Dimensi 体积	438x218x269mm (17-1/4"x8-5/8"x10-5/8")
Net Weight Berat Bersih 净重	7.1 - 7.7kg (15.6 - 17.0lbs.)
Continuous Usage Time (approx.) Masa Penggunaan Berterusan 连续使用时间	High: 12min Low: 28min with BL1850B x2

* All list price shown are for reference only (exclude SST).

* Semua harga yang ditunjukkan adalah untuk rujukan sahaja (tidak termasuk SST). 所有显示的建议零售价仅供参考 (不包括SST)。

Cordless
Tanpa Kord Tanpa Kord

LED Flashlight
Lampu Suluh LED
LED 手电筒

Vacuum Cleaner
Penyedut Vakum
吸尘器

Drilling / Fastening
Draib / Pasang
电钻 / 螺丝

Impact Drilling / Demolition
Draib / Hancurkan
电钻 / 电锤

Cutting
Memotong
电锯

Grinding / Sanding
Mengisar / Habis
电磨 / 砂纸

Sawing
Gergaji
电锯

Planing / Routing
Pegaram / Tengam
刨 / 铣

Others
Lain-lain
其他

Outdoor Power Equipment
Alatan Kuasa Luar
户外动力设备





Li-ion Ah 6.0 5.0 4.0 3.0 2.0 1.5

DDF481RTE RM 2,762	DDF481RME RM 2,615	DDF481RFE RM 2,452	DDF481Z 13mm (1/2") RM 1,477
------------------------------	------------------------------	------------------------------	--



Cordless Driver Drill
Gerudi Pemutar Skru Tanpa Kord
充电式螺丝起子电钻

- 21 Clutch settings and drill mode for added fastening control

Standard Equipment: Side Grip, Belt Clip, (+)(-) Bit, Bit Holder

- RTE: 1x Rapid Charger, 2x 5.0Ah Battery
- RME: 1x Rapid Charger, 2x 4.0Ah Battery
- RFE: 1x Rapid Charger, 2x 3.0Ah Battery
- Z: Without Charger, Battery & Carrying Case



*Not applicable for Z model



Capacity Kapasiti 能力	Steel: 13mm (1/2") Wood: 76mm (3")
Chuck Capacity Kapasiti Chuck 夹头能力	1.5 - 13mm (1/16 - 1/2")
No Load Speed (RPM) Kelajuan Tanpa Beban 回转速	High: 0 - 2,100 Low: 0 - 550
Max Fastening Torque Maksimum Tenaga Pemutaran Pengancing 最快扭力	Hard: 115N-m (1,020in.lbs.) Soft: 60N-m (530in.lbs.)
Max Lock Torque Pemutaran Tenaga Maksimum 最大扭矩	125N-m (1,090in.lbs.)
Max Output Keluaran Maksima 最大输出	640W
Dimensions (L x W x H) Dimensi 体积	205x79x266mm (8-1/8"x3-1/8"x10-1/2")
Net Weight Berat Bersih 净重	2.7 - 3.0kg (5.9 - 6.6lbs)
Work Amount (approx.) Jumlah Kerja 工作量	630 holes with BL1850B Wood bit ø21mm (25mm thick Luan)

DDF458RME RM 2,138	DDF458RFE RM 1,973	DDF458Z 13mm (1/2") RM 998	440 W
------------------------------	------------------------------	--------------------------------------	-------



Cordless Driver Drill
Gerudi Pemutar Skru Tanpa Kord
充电式螺丝起子电钻

- Mechanical 2-speed transmission covers a wide range of drilling and fastening applications

Standard Equipment: Side Grip, (+)(-) Bit, Belt Clip, Bit Holder

- RME: 1x Rapid Charger, 2x 4.0Ah Battery
- RFE: 1x Rapid Charger, 2x 3.0Ah Battery
- Z: Without Charger, Battery & Carrying Case



*Not applicable for Z model



Capacity Kapasiti 能力	Steel: 13mm (1/2") Wood: 76mm (3")
No Load Speed (RPM) Kelajuan Tanpa Beban 回转速	High: 0-2,000 Low: 0-400
Max Fastening Torque Maksimum Tenaga Pemutaran Pengancing 最快扭力	Hard: 91N-m Soft: 58N-m
Max Lock Torque Pemutaran Tenaga Maksimum 最大扭矩	84N-m (750in.lbs.)
Dimensions (L x W x H) Dimensi 体积	225x79x259mm (8-7/8"x3-1/8"x10-1/4")
Net Weight Berat Bersih 净重	2.1 - 2.5kg (4.7 - 5.4lbs)
Work Amount (approx.) Jumlah Kerja 工作量	500 holes with BL1850B Wood bit ø21mm (25mm thick Luan)

DDF482RME RM 1,833	DDF482RFE RM 1,670	DDF482Z 13mm (1/2") RM 695	440 W
------------------------------	------------------------------	--------------------------------------	-------



Cordless Driver Drill
Gerudi Pemutar Skru Tanpa Kord
充电式螺丝起子电钻

- High speed model with compact and lightweight design

Standard Equipment: Belt Clip, (+)(-) Bit

- RME: 1x Rapid Charger, 2x 4.0Ah Battery
- RFE: 1x Rapid Charger, 2x 3.0Ah Battery
- Z: Without Charger, Battery & Carrying Case



*Not applicable for Z model



Capacity Kapasiti 能力	Steel: 13mm (1/2") Wood: 38mm (1-1/2")
Chuck Capacity Kapasiti Chuck 夹头能力	1.5 - 13mm (1/16 - 1/2")
No Load Speed (RPM) Kelajuan Tanpa Beban 回转速	High: 0 - 1,900 Low: 0 - 600
Max Fastening Torque Maksimum Tenaga Pemutaran Pengancing 最快扭力	Hard: 62N-m (550in.lbs.) Soft: 36N-m (320in.lbs.)
Max Lock Torque Pemutaran Tenaga Maksimum 最大扭矩	54N-m (480in.lbs.)
Dimensions (L x W x H) Dimensi 体积	185x79x249mm (7-1/4"x3-1/8"x9-3/4")
Net Weight Berat Bersih 净重	1.5 - 1.8kg (3.2 - 4.0lbs)
Work Amount (approx.) Jumlah Kerja 工作量	781 holes with BL1850B Brad Point Wood bit ø8mm (1" Depth Mixed wood)

DDF484RTE RM 2,242	DDF484RME RM 2,097	DDF484RFE RM 1,932	DDF484Z 13mm (1/2") RM 957
------------------------------	------------------------------	------------------------------	--------------------------------------



Cordless Driver Drill
Gerudi Pemutar Skru Tanpa Kord
充电式螺丝起子电钻

- Delivers 25% more drilling, driving and fastening speed

Standard Equipment: Belt Clip, (+)(-) Bit

- RTE: 1x Rapid Charger, 2x 5.0Ah Battery
- RME: 1x Rapid Charger, 2x 4.0Ah Battery
- RFE: 1x Rapid Charger, 2x 3.0Ah Battery
- Z: Without Charger, Battery & Carrying Case



*Not applicable for Z model



Capacity Kapasiti 能力	Steel: 13mm (1/2") Wood: 38mm (1-1/2")
Chuck Capacity Kapasiti Chuck 夹头能力	1.5 - 13mm (1/16 - 1/2")
No Load Speed (RPM) Kelajuan Tanpa Beban 回转速	High: 0 - 2,000 Low: 0 - 500
Max Fastening Torque Maksimum Tenaga Pemutaran Pengancing 最快扭力	Hard: 54N-m (480in.lbs.) Soft: 30N-m (270in.lbs.)
Max Lock Torque Pemutaran Tenaga Maksimum 最大扭矩	60N-m (530in.lbs.)
Dimensions (L x W x H) Dimensi 体积	172x79x261mm (6-3/4"x3-1/8"x10-1/4")
Net Weight Berat Bersih 净重	1.5 - 1.8kg (3.3 - 4.0lbs)
Work Amount (approx.) Jumlah Kerja 工作量	1550 holes with BL1850B Wood bit ø9mm (30mm thick Luan)

DDF485RFE RM 1,760	DDF485Z 13mm (1/2") RM 785
------------------------------	--------------------------------------



Cordless Driver Drill
Gerudi Pemutar Skru Tanpa Kord
充电式螺丝起子电钻

- Variable 2-speed for a wide range of drilling and fastening applications

Standard Equipment: Belt Clip, (+)(-) Bit

- RFE: 1x Rapid Charger, 2x 3.0Ah Battery
- Z: Without Charger, Battery & Carrying Case



*Not applicable for Z model



Capacity Kapasiti 能力	Steel: 13mm (1/2") Wood: 38mm (1-1/2")
Chuck Capacity Kapasiti Chuck 夹头能力	1.5 - 13mm (1/16 - 1/2")
No Load Speed (RPM) Kelajuan Tanpa Beban 回转速	High: 0- 1,900 Low: 0 - 500
Max Fastening Torque Maksimum Tenaga Pemutaran Pengancing 最快扭力	Hard: 50N-m (440in.lbs.) Soft: 27N-m (240in.lbs.)
Max Lock Torque Pemutaran Tenaga Maksimum 最大扭矩	50N-m (440in.lbs.)
Max Output Keluaran Maksima 最大输出	350W
Clutch Torque Setting Tetapan Pemutaran 扭转设置	1.0 - 5.0N-m (9 - 44in.lbs.)
Dimensions (L x W x H) Dimensi 体积	169x79x255mm (7-1/8"x3-1/8"x10")
Net Weight Berat Bersih 净重	1.4 - 1.7kg (3.1 - 3.8lbs.)
Work Amount (approx.) Jumlah Kerja 工作量	1400 pcs with BL1850B Auger Bit ø15mm (30mm thick Melapi)

* All list price shown are for reference only (exclude SST).

* Semua harga yang ditunjukkan adalah untuk rujukan sahaja (tidak termasuk SST). 所有显示的建议零售价仅供参考 (不包括SST)。

Cordless
Tanpa Kord / 无线

LED Flashlight
Lampu Cahaya LED
LED 闪光灯

Vacuum Cleaner
Penyedut Vakuum
吸尘器

Drilling / Fastening
Gerudi / Pengancing
钻孔 / 紧固

Impact Drilling / Demolition
Gerudi / Pencahacian
冲击钻孔 / 拆除施工

Cutting / Pruning
Pemotongan
切割 / 修剪

Grinding / Sanding
Pengiraian / Pemochan
磨削 / 打磨

Sawing
Gugutan
锯切

Planing / Routing
Penghaluan / Tangkapan
刨平 / 封边

Others
Lain-lain
其他

Outdoor Power Equipment
Alatan Kerja Luar
户外动力设备



18V

LXT

Li-ion Ah 6.0 5.0 4.0 3.0 2.0 1.5

DDF459RME **DDF459Z** 13mm (1/2")
RM 1,853 RM 713

Cordless Driver Drill
Gerudi Pemutar Skru Tanpa Kord
充电式螺丝起子电钻



- Brushless motor delivers up to 50% longer run time per charge

Standard Equipment: Belt Clip, (+/-) Bit

- RME: 1x Rapid Charger, 2x 4.0Ah Battery
- Z: Without Charger, Battery & Carrying Case



Capacity Kapasiti 能力	Steel: 13mm (1/2") Wood: 38mm (1-1/2")
Chuck Capacity Kapasiti Chuck 夹头能力	1.5 - 13mm (1/16 - 1/2")
No Load Speed (RPM) Kelajuan Tanpa Beban 回转速	High: 0 - 1,500 Low: 0 - 400
Max Fastening Torque Maksimum Tenaga Pemutaran Pengancing 最快扭力	Hard: 45N-m (400in.lbs.) Soft: 25N-m (220in.lbs.)
Max Lock Torque Pemutaran Tenaga Maksimum 最大扭力	45N-m (400in.lbs.)
Dimensions (L x W x H) Dimensi 体积	179x78x256mm (7"x3-1/16"x10-1/8")
Net Weight Berat Bersih 淨重	1.4 - 1.7kg (3.1 - 3.8lbs)
Work Amount (approx.) Jumlah Kerja 工作量	1470 pcs with BL1850B Auger Bit ø15mm (30mm thick Melap)

DDF453RME **DDF453RFE** **DDF453SYE** **DDF453Z** 13mm (1/2")
RM 1,643 RM 1,478 RM 1,343 RM 503

Cordless Driver Drill
Gerudi Pemutar Skru Tanpa Kord
充电式螺丝起子电钻



- All metal gear construction ensures high transmission durability

Standard Equipment: (+/-) Bit

- RME: 1x Rapid Charger, 2x 4.0Ah Battery
- RFE: 1x Rapid Charger, 2x 3.0Ah Battery
- SYE: 1x Standard Charger, 2x 1.5Ah Battery
- Z: Without Charger, Battery, Bit & Carrying Case



Capacity Kapasiti 能力	Steel: 13mm (1/2") Wood: 36mm (1-7/16")
No Load Speed (RPM) Kelajuan Tanpa Beban 回转速	High: 0-1,300 Low: 0-400
Max Fastening Torque Maksimum Tenaga Pemutaran Pengancing 最快扭力	Hard: 42N-m Soft: 27N-m
Max Lock Torque Pemutaran Tenaga Maksimum 最大扭力	38N-m (340in.lbs.)
Dimensions (L x W x H) Dimensi 体积	222x79x244mm (8-3/4"x3-1/8"x9-5/8")
Net Weight Berat Bersih 淨重	1.7 - 2.0kg (3.7 - 4.4lbs)
Work Amount (approx.) Jumlah Kerja 工作量	720 pcs with BL1850B Wood screw ø4.1 x 38mm

DDF483RTE **DDF483RME** **DDF483RFE** **DDF483Z** 13mm (1/2")
RM 2,052 RM 1,907 RM 1,743 RM 768

Cordless Driver Drill
Gerudi Pemutar Skru Tanpa Kord
充电式螺丝起子电钻



- BL motor delivers 40N-m of max torque

Standard Equipment: Belt Clip, (+/-) Bit

- RTE: 1x Rapid Charger, 2x 5.0Ah Battery
- RME: 1x Rapid Charger, 2x 4.0Ah Battery
- RFE: 1x Rapid Charger, 2x 3.0Ah Battery
- Z: Without Charger, Battery & Carrying Case



Capacity Kapasiti 能力	Steel: 13mm (1/2") Wood: 36mm (1-7/16")
Chuck Capacity Kapasiti Chuck 夹头能力	1.5 - 13mm (1/16 - 1/2")
No Load Speed (RPM) Kelajuan Tanpa Beban 回转速	High: 0 - 1,700 Low: 0 - 500
Max Fastening Torque Maksimum Tenaga Pemutaran Pengancing 最快扭力	Hard: 40N-m (350in.lbs.) Soft: 23N-m (210in.lbs.)
Max Lock Torque Pemutaran Tenaga Maksimum 最大扭力	40N-m (350in.lbs.)
Dimensions (L x W x H) Dimensi 体积	162x79x247mm (6-3/8"x3-1/8"x9-3/4")
Net Weight Berat Bersih 淨重	1.2 - 1.6kg (2.7 - 3.4lbs)
Work Amount (approx.) Jumlah Kerja 工作量	1666 pcs with BL1850B Wood Bit ø9mm (30mm thick Lauan)

DDF083RTE **DDF083RFE** **DDF083Z** 13mm (1/2")
RM 2,007 RM 1,698 RM 722

Cordless Driver Drill
Gerudi Pemutar Skru Tanpa Kord
充电式螺丝起子电钻



- Mechanical 2-speed transmission covers a wide range of drilling and fastening applications

Standard Equipment: Belt Clip, Phillips Bit

- RTE: 1x Rapid Charger, 2x 5.0Ah Battery
- RFE: 1x Rapid Charger, 2x 3.0Ah Battery
- Z: Without Charger, Battery & Carrying Case



Capacity Kapasiti 能力	Steel: 13mm (1/2") Wood: 36mm (1-7/16")
Chuck Capacity Kapasiti Chuck 夹头能力	6.35mm (1/4")
No Load Speed (RPM) Kelajuan Tanpa Beban 回转速	High: 0 - 1,700 Low: 0 - 500
Max Fastening Torque Maksimum Tenaga Pemutaran Pengancing 最快扭力	Hard: 40N-m (350in.lbs.) Soft: 23N-m (210in.lbs.)
Max Lock Torque Pemutaran Tenaga Maksimum 最大扭力	40N-m (350in.lbs.)
Dimensions (L x W x H) Dimensi 体积	124x79x247mm (4-7/8"x3-1/8"x9-3/4")
Net Weight Berat Bersih 淨重	1.1 - 1.4kg (2.4 - 3.0lbs)
Work Amount (approx.) Jumlah Kerja 工作量	1666 pcs with BL1850B Wood Bit ø9mm (30mm thick Lauan)

Model No. 型号	Capacity Kapasiti 能力		No Load Speed (rpm) Kelajuan Tanpa Beban 回转速	Mechanical Speed Mekanikal Kelajuan 机械速度	Torque Setting Tetapan Pemutaran 扭转设置	Max. Fastening Torque Maksimum Tenaga Pemutaran Pengancing 最快扭力	Overall Length (mm) Panjang Keseluruhan 总长度	Net Weight Berat Bersih 淨重	BL MOTOR	XPT
	Steel	Wood								
DDF481	13mm	76mm	0-2,100 / 0-550	2 Speed	21	Hard: 115 / Soft: 60	205	2.7kg (5.9lbs)	●	●
DDF458	13mm	76mm	0-2,000 / 0-400	2 Speed	21	Hard: 91 / Soft: 58	225	2.1kg (4.7lbs)	●	●
DDF482	13mm	38mm	0 - 1,900 / 0 - 600	2 Speed	21	Hard: 62 / Soft: 36	185	1.5kg (3.2lbs)	●	●
DDF484	13mm	38mm	0-2,000 / 0-500	2 Speed	21	Hard: 54 / Soft: 30	172	1.5kg (3.3lbs)	●	●
DDF485	13mm	38mm	0-1,900 / 0-500	2 Speed	21	Hard: 50 / Soft: 27	169	1.4kg (3.1lbs)	●	●
DDF459	13mm	38mm	0-1,500 / 0-400	2 Speed	16	Hard: 45 / Soft: 25	179	1.4kg (3.1lbs)	●	●
DDF453	13mm	36mm	0-1,300 / 0-400	2 Speed	16	Hard: 42 / Soft: 27	222	1.7kg (3.7lbs)	●	●
DDF483	13mm	36mm	0-1,700 / 0-500	2 Speed	20	Hard: 40 / Soft: 23	162	1.2kg (2.7lbs)	●	●
DDF083	13mm	36mm	0-1,700 / 0-500	2 Speed	20	Hard: 40 / Soft: 23	124	1.1kg (2.4lbs)	●	●

* All list price shown are for reference only (exclude SST).

* Semua harga yang ditunjukkan adalah untuk rujukan sahaja (tidak termasuk SST). 所有显示的建议零售价仅供参考 (不包括SST)。

Cordless Impact Driver
LED Flashlight Lampu Suluh LED
Vacuum Cleaner
Drilling / Fastening
Impact Drilling / Demolition
Cutting
Grinding / Sanding
Sawing
Planing / Routing
Others
Outdoor Power Equipment



BRUSHLESS MOTOR

Motor tanpa berus 无碳刷马达

- Maintenance-free due to no brush
- Life time work amount of a battery is increased
- Durable against long continuous operation
- More work amount on a single full battery charge

penyenggaraan mudah tanpa proses penggantian berus karbon. Alat yang menggunakan motor berus BL tidak mengalami geseran haba, dengan itu menjadikan bateri lebih tahan lama.

免却更换碳刷的高频工序，保养轻松简单。

采用BL无碳刷马达的工具没有因摩擦热导致的能量流失，所以每次充电后的连续工作时间更长。



BRUSHED MOTOR

Motor dengan berus 有刷马达

- High power-to-weight ratio obtained by employing 4-pole motor

Berkuasa tinggi dengan motor 4-pole
采用4极马达，高功率

4-POLE MOTOR **2-POLE MOTOR**



Max Fastening Torque

Maksimum Tenaga Pemutaran Pengancing
最大扭矩

Soft Joint



Max Fastening Torque

Maksimum Tenaga Pemutaran Pengancing
最大扭矩

Hard Joint



Max Fastening Torque

Maksimum Tenaga Pemutaran Pengancing
最大扭矩

Soft Joint



* All list price shown are for reference only (exclude SST).

* Semua harga yang ditunjukkan adalah untuk rujukan sahaja (tidak termasuk SST). 所有显示的建议零售价仅供参考 (不包括SST)。

Cordless
Tangan-tangan

LED Flashlight
Lampu Saku LED
LEO00001

Vacuum Cleaner
Penyedut Vakuum
VAC00001

Drilling / Fastening
Gerudi / Pengancing
DHP00001

Impact Drilling / Demolition
Gerudi / Pencah
DHP00002

Cutting / Penampang
DHP00003

Grinding / Sanding
Pengisar / Pencil
DHP00004

Sawing / Gajuh
DHP00005

Planing / Routing
Penghalus / Tangan
DHP00006

Others
Lain-lain
DHP00007

Outdoor Power Equipment
Alatan Kerja Luar
DHP00008





DHP481RTE RM 2,817 | **DHP481RFE** RM 2,507 | **DHP481Z** 13mm (1/2") RM 1,532

Cordless Hammer Driver Drill

Tukul Pemutar Skru Bergerudi Tanpa Kord
充电式冲击螺丝起子电钻

- 0-31,500 IPM for fast hammer drilling in masonry materials

Standard Equipment: Depth Gauge, Side Grip, Belt Clip, (+/-) Bit, Bit Holder

- RTE: 1x Rapid Charger, 2x 5.0Ah Battery
- RFE: 1x Rapid Charger, 2x 3.0Ah Battery
- Z: Without Charger, Battery & Carrying Case



Capacity Kapasiti 能力	Steel: 13mm (1/2") Wood: 76mm (3") Masonry: 16mm (5/8")
Chuck Capacity Kapasiti Chuck 夹头能力	1.5 - 13mm (1/16 - 1/2")
Impacts Per Minute (IPM) Impak Per Minit 冲击数	High: 0 - 31,500 Low: 0 - 8,250
No Load Speed (RPM) Kelajuan Tanpa Beban 回转数	High: 0 - 2,100 Low: 0 - 550
Max Fastening Torque Maksimum Tenaga Pemutaran Pengancing 最快扭力	Hard: 115N-m (1,020in.lbs.) Soft: 60N-m (530in.lbs.)
Max Lock Torque Pemutaran Tenaga Maksimum 最大扭力	125N-m (1,090in.lbs.)
Dimensions (L x W x H) Dimensi 体积	205x79x249mm (8-1/8"x3-1/8"x9-3/4")
Net Weight Berat Bersih 淨重	2.7 - 3.0kg (6.0 - 6.7lbs)
Work Amount (approx.) Jumlah Kerja 工作量	630 pcs with BL1850B Wood Screw ø21 x 25mm

DHP458RME RM 2,188 | **DHP458RFE** RM 2,023 | **DHP458Z** 13mm (1/2") RM 1,048

Cordless Hammer Driver Drill

Tukul Pemutar Skru Bergerudi Tanpa Kord
充电式冲击螺丝起子电钻

- All metal gears and aluminum gear housing for maximum jobsite durability

Standard Equipment: (+/-) Bit, Side Grip, Depth Rod, Bit Holder

- RME: 1x Rapid Charger, 2x 4.0Ah Battery
- RFE: 1x Rapid Charger, 2x 3.0Ah Battery
- Z: Without Charger, Battery & Carrying Case



Capacity Kapasiti 能力	Steel: 13mm (1/2") Wood: 76mm (3") Masonry: 16mm (5/8")
No Load Speed (RPM) Kelajuan Tanpa Beban 回转数	High: 0-2,000 Low: 0-400
Impacts Per Minute (IPM) Impak Per Minit 冲击数	High: 0-30,000 Low: 0-6,000
Max Fastening Torque Maksimum Tenaga Pemutaran Pengancing 最快扭力	Hard: 91N-m Soft: 58N-m
Max Lock Torque Pemutaran Tenaga Maksimum 最大扭力	84N-m (750in.lbs.)
Dimensions (L x W x H) Dimensi 体积	225x79x259mm (8-7/8"x3-1/8"x10-1/4")
Net Weight Berat Bersih 淨重	2.2 - 2.6kg (4.9 - 5.7lbs)
Work Amount (approx.) Jumlah Kerja 工作量	500 pcs with BL1850B Wood Screw ø9 x 25mm

DHP482RME RM 1,870 | **DHP482RFE** RM 1,707 | **DHP482RFX1** RM 1,748 | **DHP482Z** 13mm (1/2") RM 732

Cordless Hammer Driver Drill

Tukul Pemutar Skru Bergerudi Tanpa Kord
充电式冲击螺丝起子电钻

- High speed model with compact and lightweight design

Standard Equipment: Belt Clip, (+/-) Bit

- RME: 1x Rapid Charger, 2x 4.0Ah Battery
- RFE: 1x Rapid Charger, 2x 3.0Ah Battery
- RFX1: 1x Rapid Charger, 1x 3.0Ah Battery, Accessories Set
- Z: Without Charger, Battery & Carrying Case



Capacity Kapasiti 能力	Steel: 13mm (1/2") Wood: 38mm (1-1/2") Masonry: 13mm (1/2")
Chuck Capacity Kapasiti Chuck 夹头能力	1.5 - 13mm (1/16 - 1/2")
Impacts Per Minute (IPM) Impak Per Minit 冲击数	High: 0 - 28,500 Low: 0 - 9,000
No Load Speed (RPM) Kelajuan Tanpa Beban 回转数	High: 0 - 1,900 Low: 0 - 600
Max Fastening Torque Maksimum Tenaga Pemutaran Pengancing 最快扭力	Hard: 62N-m (550 in.lbs.) Soft: 36N-m (320 in.lbs.)
Max Lock Torque Pemutaran Tenaga Maksimum 最大扭力	54N-m (480in.lbs.)
Dimensions (L x W x H) Dimensi 体积	198x79x249mm (7-3/4"x3-1/8"x9-3/4")
Net Weight Berat Bersih 淨重	1.5 - 1.8kg (3.4 - 4.1lbs)
Work Amount (approx.) Jumlah Kerja 工作量	781 holes with BL1850B Brad Point Wood Bit ø8mm (1" Depth Mixed wood)

DHP484RME RM 2,152 | **DHP484RFE** RM 1,987 | **DHP484Z** 13mm (1/2") RM 1,012

Cordless Hammer Driver Drill

Tukul Pemutar Skru Bergerudi Tanpa Kord
充电式冲击螺丝起子电钻

- 0-30,000 IPM for fast hammer drilling in masonry materials

Standard Equipment: Belt Clip, (+/-) Bit

- RME: 1x Rapid Charger, 2x 4.0Ah Battery
- RFE: 1x Rapid Charger, 2x 3.0Ah Battery
- Z: Without Charger, Battery & Carrying Case



Capacity Kapasiti 能力	Steel: 13mm (1/2") Wood: 38mm (1-1/2") Masonry: 13mm (1/2")
Chuck Capacity Kapasiti Chuck 夹头能力	1.5 - 13mm (1/16 - 1/2")
Impacts Per Minute (IPM) Impak Per Minit 冲击数	High: 0 - 30,000 Low: 0 - 7,500
No Load Speed (RPM) Kelajuan Tanpa Beban 回转数	High: 0 - 2,000 Low: 0 - 2,000
Max Fastening Torque Maksimum Tenaga Pemutaran Pengancing 最快扭力	Hard: 54 N-m (480 in.lbs.) Soft: 30 N-m (270 in.lbs.)
Max Lock Torque Pemutaran Tenaga Maksimum 最大扭力	60N-m (530in.lbs.)
Dimensions (L x W x H) Dimensi 体积	182x79x261mm (7-1/8"x3-1/8"x10-1/4")
Net Weight Berat Bersih 淨重	1.6 - 1.9kg (3.5 - 4.2lbs)
Work Amount (approx.) Jumlah Kerja 工作量	1850 pcs with BL1850B Wood Screw ø9 x 25mm

DHP485RFE RM 1,795 | **DHP485Z** 13mm (1/2") RM 820

Cordless Hammer Driver Drill

Tukul Pemutar Skru Bergerudi Tanpa Kord
充电式冲击螺丝起子电钻

- All metal gear construction provides increased durability

Standard Equipment: Belt Clip, (+/-) Bit

- RFE: 1x Rapid Charger, 2x 3.0Ah Battery
- Z: Without Charger, Battery & Carrying Case



Capacity Kapasiti 能力	Steel: 13 (1/2") Wood: 38 (1-1/2") Masonry: 13mm (1/2")
Chuck Capacity Kapasiti Chuck 夹头能力	1.5 - 13mm (1/16 - 1/2")
Impacts Per Minute (IPM) Impak Per Minit 冲击数	High: 0 - 28,500 Low: 0 - 7,500
No Load Speed (RPM) Kelajuan Tanpa Beban 回转数	High: 0 - 1900 Low: 0 - 500
Max Fastening Torque Maksimum Tenaga Pemutaran Pengancing 最快扭力	Hard: 50N-m (440in.lbs.) Soft: 27N-m (240in.lbs.)
Max Lock Torque Pemutaran Tenaga Maksimum 最大扭力	50N-m (440in.lbs.)
Dimensions (L x W x H) Dimensi 体积	182x79x255mm (7-1/8"x3-1/8"x10")
Net Weight Berat Bersih 淨重	1.5 - 1.8kg (3.2 - 3.9lbs.)
Work Amount (approx.) Jumlah Kerja 工作量	1400 pcs with BL1850B Auger Bit ø15mm (30mm thick Melap)

* All list price shown are for reference only (exclude SST).

* Semua harga yang ditunjukkan adalah untuk rujukan sahaja (tidak termasuk SST). 所有显示的建议零售价仅供参考 (不包括SST)。

Cordless Impact Driver
LED Flashlight
Vacuum Cleaner
Drilling / Fastening
Impact Drilling / Demolition
Cutting
Grinding / Sanding
Sawing
Planing / Routing
Others
Outdoor Power Equipment





Li-ion Ah 6.0 5.0 4.0 3.0 2.0 1.5

DHP459Z 13mm (1/2")
RM 745

Cordless Hammer Driver Drill
Tukul Pemutar Skru Bergerudi Tanpa Kord
充电式冲击螺丝起子电钻



- Brushless motor delivers up to 50% longer run time per charge

Standard Equipment: Belt Clip, (+/-) Bit
• Z: Without Charger & Battery



Capacity Kapasiti 能力	Steel: 13mm (1/2") Wood: 38mm (1-1/2") Masonry: 13mm (1/2")
Chuck Capacity Kapasiti Chuck 夹头能力	1.5 - 13mm (1/16 - 1/2")
Impacts Per Minute (IPM) Impak Per Minit 冲击数	High: 0 - 22,500 Low: 0 - 6,000
No Load Speed (RPM) Kelajuan Tanpa Beban 回转数	High: 0 - 1,500 Low: 0 - 400
Max Fastening Torque Maksimum Tenaga Pemutaran Pengancing 最快扭力	Hard: 45N-m (400in.lbs.) Soft: 25N-m (220in.lbs.)
Max Lock Torque Pemutaran Tenaga Maksimum 最大扭力	45N-m (400in.lbs.)
Dimensions (L x W x H) Dimensi 体积	192x78x256mm (7-9/16"x3-1/16"x10-1/8")
Net Weight Berat Bersih 净重	1.5 - 1.8kg (3.3 - 4.0lbs)
Work Amount Jumlah Kerja 工作量	1470pcs with BL1850B Auger Bit ø15mm (30mm thick Melap)

DHP453RME DHP453RFE DHP453SYE DHP453Z 13mm (1/2")
RM 1,692 RM 1,527 RM 1,393 RM 552

Cordless Hammer Driver Drill
Tukul Pemutar Skru Bergerudi Tanpa Kord
充电式冲击螺丝起子电钻



- 16 Adjustable torque settings plus drill mode

Standard Equipment: (+/-) Bit
• RME: 1x Rapid Charger, 2x 4.0Ah Battery
• RFE: 1x Rapid Charger, 2x 3.0Ah Battery
• SYE: 1x Standard Charger, 2x 1.5Ah Battery
• Z: Without Charger, Battery & Carrying Case

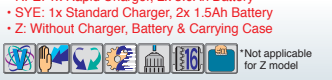

Capacity Kapasiti 能力	Steel: 13mm (1/2") Wood: 36mm (1-7/16") Masonry: 13mm (1/2")
Impacts Per Minute (IPM) Impak Per Minit 冲击数	High: 0 - 19,500 Low: 0 - 6,000
No Load Speed (RPM) Kelajuan Tanpa Beban 回转数	High: 0 - 1,300 Low: 0 - 400
Max Fastening Torque Maksimum Tenaga Pemutaran Pengancing 最快扭力	Hard: 42N-m Soft: 27N-m
Max Lock Torque Pemutaran Tenaga Maksimum 最大扭力	38N-m (340in.lbs.)
Dimensions (L x W x H) Dimensi 体积	240x79x244mm (9-7/16"x3-1/8"x9-5/8")
Net Weight Berat Bersih 净重	1.7 - 2.0kg (3.6 - 4.4lbs)
Work Amount Jumlah Kerja 工作量	720pcs with BL1850B Wood Screw ø4.1 x 38mm

DHP483RME DHP483RFE DHP483Z 13mm (1/2")
RM 1,957 RM 1,792 RM 817

Cordless Hammer Driver Drill
Tukul Pemutar Skru Bergerudi Tanpa Kord
充电式冲击螺丝起子电钻



- 0-25,500 IPM for fast hammer drilling in masonry materials

Standard Equipment: Belt Clip, (+/-) Bit
• RME: 1x Rapid Charger, 2x 4.0Ah Battery
• RFE: 1x Rapid Charger, 2x 3.0Ah Battery
• Z: Without Charger, Battery & Carrying Case

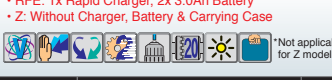

Capacity Kapasiti 能力	Steel: 13mm (1/2") Wood: 36mm (1-7/16") Masonry: 13mm (1/2")
Chuck Capacity Kapasiti Chuck 夹头能力	1.5 - 13mm (1/16 - 1/2")
Impacts Per Minute (IPM) Impak Per Minit 冲击数	High: 0 - 25,500 Low: 0 - 7,500
No Load Speed (RPM) Kelajuan Tanpa Beban 回转数	High: 0 - 1,700 Low: 0 - 500
Max Fastening Torque Maksimum Tenaga Pemutaran Pengancing 最快扭力	Hard: 40N-m (350 in.lbs.) Soft: 23N-m (210 in.lbs.)
Max Lock Torque Pemutaran Tenaga Maksimum 最大扭力	40N-m (350in.lbs.)
Dimensions (L x W x H) Dimensi 体积	176x79x247mm (6-15/16"x3-1/8"x9-3/4")
Net Weight Berat Bersih 净重	1.3 - 1.6kg (2.8 - 3.6lbs)
Work Amount Jumlah Kerja 工作量	200pcs with BL1850B Wood screw ø6 x 75mm

Model No. 型号	Capacity Kapasiti 能力			No Load Speed (rpm) Kelajuan Tanpa Beban 回转数	Impacts Per Minute (IPM) Impak Per Minit 冲击数	Torque Setting Tetapan Pemutaran 扭转设置	Max. Fastening Torque Maksimum Tenaga Pemutaran Pengancing 最快扭力	Overall Length (mm) Panjang Keseluruhan 总长度	Net Weight Berat Bersih 净重	BL MOTOR	XPT
	Steel	Wood	Mansory								
DHP481	13mm	76mm	16mm	0-2,100 / 0-550	High: 0 - 31,500 / Low: 0 - 8,250	21	Hard: 115 / Soft: 60	205	2.7kg (6.0lbs)	●	●
DHP458	13mm	76mm	16mm	0-2,000 / 0-400	High: 0 - 30,000 / Low: 0 - 6,000	21	Hard: 91 / Soft: 58	225	2.2kg (4.9lbs)	●	●
DHP482	13mm	38mm	13mm	0 - 1,900 / 0 - 600	High: 0 - 28,500 / Low: 0 - 9,000	21	Hard: 62 / Soft: 36	198	1.5kg (3.4lbs)	●	●
DHP484	13mm	38mm	13mm	0-2,000 / 0-500	High: 0 - 30,000 / Low: 0 - 7,500	21	Hard: 54 / Soft: 30	182	1.6kg (3.5lbs)	●	●
DHP485	13mm	38mm	13mm	0-1,900 / 0-500	High: 0 - 28,500 / Low: 0 - 7,500	21	Hard: 50 / Soft: 27	182	1.5kg (3.2lbs)	●	●
DHP459	13mm	38mm	13mm	0-1,500 / 0-400	High: 0 - 22,500 / Low: 0 - 6,000	16	Hard: 45 / Soft: 25	192	1.5kg (3.3lbs)	●	●
DHP453	13mm	36mm	13mm	0-1,300 / 0-400	High: 0 - 19,500 / Low: 0 - 6,000	16	Hard: 42 / Soft: 27	240	1.7kg (3.6lbs)	●	●
DHP483	13mm	36mm	13mm	0-1,700 / 0-500	High: 0 - 25,500 / Low: 0 - 7,500	20	Hard: 40 / Soft: 23	176	1.3kg (2.8lbs)	●	●

* All list price shown are for reference only (exclude SST).

* Semua harga yang ditunjukkan adalah untuk rujukan sahaja (tidak termasuk SST). 所有显示的建议零售价仅供参考 (不包括SST)。

Cordless
Tangan-tangan
LED Flashlight
Lampu Sahan LED
Vacuum Cleaner
Penyedut Vakuum
Drilling / Fastening
Ganda / Pengancing
Impact Drilling / Demolition
Dua / Hancurkan
Cutting
Pemotong
Grinding / Sanding
Pergilas / Pasir
Sanding / Grinding
Giling / Pasir
Outdoor Power Equipment
Alatan Kerja Luar
Others
Lain-lain



Cordless
Tampal Kord Tanpa Kord

LED Flashlight
Lampu Suluh LED
LED/NIRUP

Vacuum Cleaner
Penisih Nahi Vakuum
BL/UC

Drilling / Fastening
Gali / Pengikat
BL/BL

Impact Drilling / Demolition
Gali / Pemusnah
BL/BL/BL

Cutting
Pemotong
BL

Grinding / Sanding
Pengisar / Hais
BL/BL

Sawing
Gergaji
BL/BL

Planing / Routing
Pengisar / Tengam
BL/BL/BL

Others
Lain-lain
BL/BL

Outdoor Power Equipment
Alatan Kuasa Luar
BL/BL/BL

Makita
Makita

BRUSHLESS MOTOR

Motor tanpa berus 无碳刷马达

- Maintenance-free due to no brush
 - Life time work amount of a battery is increased
 - Durable against long continuous operation
 - More work amount on a single full battery charge
- penyelenggaraan mudah tanpa proses penggantian berus karbon
Alat yang menggunakan motor berus BL tidak mengalami geseran haba, dengan itu menjadikan bateri lebih tahan lama
免却更换碳刷的前项工序, 保养较简单
采用BL无碳刷马达的工具没有因摩擦热导致的能量流失, 所以每次充电后的连续工作时间更长



BRUSHED MOTOR

Motor dengan berus 有刷马达

- High power-to-weight ratio obtained by employing 4-pole motor
- Berkuasa tinggi dengan motor 4-pole
采用4极马达, 高功率

4-POLE MOTOR



Max Fastening Torque

Maksimum Tenaga Pemutaran Pengancing 最快扭力

180 N·m

175 N·m

170 N·m

165 N·m

140 N·m

A mode [assist mode]

helps to eliminate "screw cam-out" and "cross threading" by driving at low speed until the start of tightening.

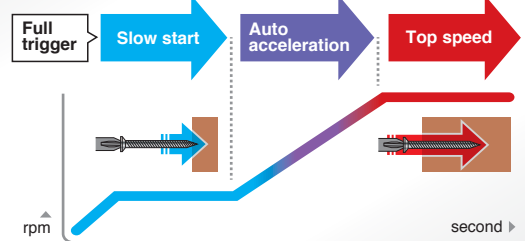

DTD171

Cordless Impact Driver
Pemutar Skru Impak tanpa Kord 充电式冲击螺丝起子机

BL MOTOR XPT

4 STAGE power selection + TEKS MODE

CA +



DTD170

Cordless Impact Driver
Pemutar Skru Impak tanpa Kord 充电式冲击螺丝起子机

BL MOTOR XPT

4 STAGE power selection + TEKS MODE + CA



DTD154

Cordless Impact Driver
Pemutar Skru Impak tanpa Kord 充电式冲击螺丝起子机

BL MOTOR XPT

3 STAGE power selection + TEKS MODE



DTD153

Cordless Impact Driver
Pemutar Skru Impak tanpa Kord 充电式冲击螺丝起子机

BL MOTOR XPT

Ideal for applications such as tightening of self-drilling screws



DTD155

Cordless Impact Driver
Pemutar Skru Impak tanpa Kord 充电式冲击螺丝起子机

BL MOTOR XPT

2 STAGE power selection + CA

DTD149

Cordless Impact Driver
Pemutar Skru Impak tanpa Kord 充电式冲击螺丝起子机

XPT 4-POLE MOTOR



DTD152

Cordless Impact Driver
Pemutar Skru Impak tanpa Kord 充电式冲击螺丝起子机

XPT 4-POLE MOTOR

Ideal for applications such as tightening of self-drilling screws



DTS141

Cordless Oil-Pulse Driver
Pemutar Skru Impak tanpa Kord 充电式冲击起子机

BL MOTOR XPT

3 STAGE power selection + TEKS MODE

Suitable for noise sensitive job site

SOFT IMPACT

Low Noise 77dB

40 N·m



DTP141

Cordless 4 Mode Impact Driver
Pemutar Skru Impak tanpa Kord 充电式冲击螺丝起子机

BL MOTOR

3 STAGE power selection + TEKS MODE

4 Operation modes
Impact driver/
Hammer drill/ Drill/
Screwdriver



150 N·m



"Tek's" mode is a special mode optimum for fast tightening of self drilling screws without damaging the screw and the workpiece.

"Tek's" mod adalah mod khas yang optimum untuk mengikatkan skru penggerudian sendiri tanpa cepat merosakkan skru dan bahan kerja.

"Tek's" 模式是一种特殊模式, 可以在不损坏螺钉和工件的情况下快速拧紧自攻螺钉。

Tek's mode

* All list price shown are for reference only (exclude SST).

* Semua harga yang ditunjukkan adalah untuk rujukan sahaja (tidak termasuk SST). 所有显示的建议零售价仅供参考 (不包括SST)。

18V

LXT

Li-ion Ah 6.0 5.0 4.0 3.0 2.0 1.5

Cordless Impact Driver

Pemutar Skru Impak Tanpa Kord 充电式冲击螺丝起子机

4 ASSIST MODE

4 jenis mod kerja 4 协助工作模式

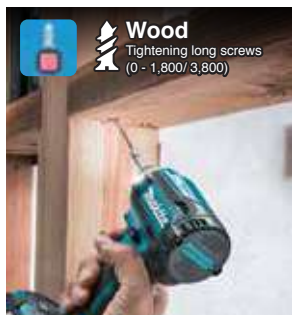

BALL BEARING provides reduction of bit wobbling

Gelas bola mengurangkan goyangan kepada mata gerudi
滚珠轴承可减少钻头摆动

One touch bit installation

Pemasangan satu klik
一键式安装

Quick mode-switching function

Mod kawalan manual
手动直接控制模式开关

Variable Speed Control by Trigger

Pencetus kawalan kelajuan
触发控制变速

4 STAGE IMPACT POWER SELECTION

Pemilihan kuasa 4 peringkat 4 模式冲击力选择



DTD171RTJ RM 2,762 | **DTD171RFJ** RM 2,452 | **DTD171Z** RM 1,477

Cordless Impact Driver
Pemutar Skru Impak Tanpa Kord
充电式冲击螺丝起子机



• Ultra Compact and perfect balance at only 116mm long

Standard Equipment: Belt Clip

- RTJ: 1x Rapid Charger, 2x 5.0Ah Battery, 1x Makpac Connector Box
- RFJ: 1x Rapid Charger, 2x 3.0Ah Battery, 1x Makpac Connector Box
- Z: Without Charger, Battery & Carrying Case



*Not applicable for Z model



Capacity Kapasiti 能力	Machine Screw: M4 - M8 (5/32" - 5/16") Standard Bolt: M5 - M16 (3/16" - 5/8") High Tensile Bolt: M5 - M14 (3/16" - 9/16") Coarse thread (in length): 22 - 125mm (7/8" - 4-7/8") 6.35mm (1/4")
Hex Shank Batang Heksagon 六角柄	
No Load Speed (RPM) Kelajuan Tanpa Beban 回转数	Max/ Hard/ Med/ Soft/ Wood/ Bolt/ T(1) T(2) mode: 0 - 3,600/ 3,200/ 2,100/ 1,100/ 1,800/ 3,600/ 2,900/ 3,600
Impacts Per Minute (IPM) Impak Per Minit 冲击力	Max/ Hard/ Med/ Soft/ Wood/ Bolt/ T(1) T(2) mode: 0 - 3,800/ 3,600/ 2,600/ 1,100/ 3,800/ 3,800/ N/A/ 2,600
Max Fastening Torque Maksimum Tenaga Pemutaran Pengancing 最快扭力	180N-m (1,590in.lbs.)
Fastening Torque Tenaga Pemutaran Pengancing 扭力	Hard: 170N-m (1,510in.lbs.) Med: 50N-m (440in.lbs.) Soft: 20 N-m (180 in.lbs.)
Dimensions (L x W x H) Dimensi 体积	116x79x236mm (4-9/16"x3-1/8"x9-1/4")
Net Weight Berat Bersih 净重	1.2 - 1.6kg (2.7 - 3.4lbs.)
Work Amount (approx.) Jumlah Kerja 工作量	808 pcs with BL1850B coarse thread screw 65mm

DTD170RME RM 2,553 | **DTD170RFE** RM 2,390 | **DTD170Z** RM 1,415

Cordless Impact Driver
Pemutar Skru Impak Tanpa Kord
充电式冲击螺丝起子机



• 6-Mode operation for A-mode/ T-mode/ Max/ Hard/ Medium/ Soft impact mode for multiple applications

Standard Equipment: Belt Clip

- RME: 1x Rapid Charger, 2x 4.0Ah Battery
- RFE: 1x Rapid Charger, 2x 3.0Ah Battery
- Z: Without Charger, Battery & Carrying Case



*Not applicable for Z model



Capacity Kapasiti 能力	Machine Screw: M4 - M8 (5/32" - 5/16") Standard Bolt: M5 - M16 (3/16" - 5/8") High Tensile Bolt: M5 - M14 (3/16" - 9/16") Coarse Thread (in length): 22 - 125mm (7/8" - 4-7/8") 6.35mm (1/4")
Hex Shank Batang Heksagon 六角柄	
No Load Speed (RPM) Kelajuan Tanpa Beban 回转数	Max: 0 - 3,600 Hard: 3,200 Med: 2,100 Soft: 1,100 T Mode: 3,600
Impacts Per Minute (IPM) Impak Per Minit 冲击力	Max: 0 - 3,800 Hard: 3,600 Med: 2,600 Soft: 1,100 T mode: 2,600
Max Fastening Torque Maksimum Tenaga Pemutaran Pengancing 最快扭力	175N-m (1,550in.lbs.)
Dimensions (L x W x H) Dimensi 体积	117x79x236mm (4-5/8"x3-1/8"x9-1/4")
Net Weight Berat Bersih 净重	1.2 - 1.5kg (2.7 - 3.4lbs)
Work Amount (approx.) Jumlah Kerja 工作量	808 pcs with BL1850B coarse thread screw 65mm

* All list price shown are for reference only (exclude SST).

* Semua harga yang ditunjukkan adalah untuk rujukan sahaja (tidak termasuk SST). 所有显示的建议零售价仅供参考 (不包括SST)。

Cordless
Tanpa Kord 充电式

LED Flashlight
Lampu Cahaya LED
LED 闪光灯

Vacuum Cleaner
Penyedut Vakuum
吸尘器

Drilling / Fastening
Gerudi / Pasang
钻孔 / 紧固

Impact Drilling / Demolition
Gerudi / Hancurkan
冲击钻孔 / 拆除

Cutting
Pemotong
切割

Grinding / Sanding
Pergasi / Rata
打磨 / 磨光

Sawing
Gergaji
锯切

Planing / Routing
Pegilasan / Tangan
刨平 / 铣削

Others
Lain-lain
其他

Outdoor Power Equipment
Alatan Kerja Luar
户外动力设备

Makita
MAKITA



Li-ion Ah 6.0 | 5.0 | 4.0 | 3.0 | 2.0 | 1.5

DTD154RME | **DTD154RFE** | **DTD154Z**
 RM 2,127 | RM 1,963 | RM 988

Cordless Impact Driver
 Pemutar Skru Impak Tanpa Kord
 充电式冲击螺丝起子机



- Aluminum hammer case creates the impression of rigidity of the machine

Standard Equipment: Belt Clip

- RME: 1x Rapid Charger, 2x 4.0Ah Battery
- RFE: 1x Rapid Charger, 2x 3.0Ah Battery
- Z: Without Charger, Battery & Carrying Case



Capacity Kapasiti 能力	Machine Screw: M4 - M8 (5/32" - 5/16") Standard Bolt: M5 - M16 (3/16" - 5/8") High Tensile Bolt: M5 - M14 (3/16" - 9/16") Coarse Thread (in length): 22 - 125mm (7/8" - 4-7/8") 6.35mm (1/4")
Hex Shank Batang Heksagon 六角柄	
No Load Speed (RPM) Kelajuan Tanpa Beban 回转数	0 - 3,600 0 - 2,100 0 - 1,100
Impacts Per Minute (IPM) Impak Per Minit 冲击数	0 - 3,800 0 - 2,600 0 - 1,100
Max Fastening Torque Maksimum Tenaga Pemutaran Pengancing 最快扭力	175N-m (1,550in.lbs.)
Dimensions (L x W x H) Dimensi 体积	117x79x236mm (4-5/8"x3-1/8"x9-1/4")
Net Weight Berat Bersih 淨重	1.3 - 1.6kg (2.7 - 3.4lbs)
Work Amount (approx.) Jumlah Kerja 工作量	800 pcs with BL1850B Wood screw ø4.3 x 65mm

DTD153RTE | **DTD153RFE** | **DTD153Z**
 RM 2,102 | RM 1,792 | RM 817

Cordless Impact Driver
 Pemutar Skru Impak Tanpa Kord
 充电式冲击螺丝起子机



- Aluminum hammer case creates the impression of rigidity of the machine

Standard Equipment: Belt Clip

- RTE: 1x Rapid Charger, 2x 5.0Ah Battery
- RFE: 1x Rapid Charger, 2x 3.0Ah Battery
- Z: Without Charger, Battery & Carrying Case



Capacity Kapasiti 能力	Machine Screw: M4 - M8 (5/32" - 5/16") Standard Bolt: M5 - M16 (3/16" - 5/8") High Tensile Bolt: M5 - M14 (3/16" - 9/16") Coarse Thread (in length): 22 - 125mm (7/8" - 4-7/8") 6.35mm (1/4")
Hex Shank Batang Heksagon 六角柄	
No Load Speed (RPM) Kelajuan Tanpa Beban 回转数	0 - 3,400
Impacts Per Minute (IPM) Impak Per Minit 冲击数	0 - 3,600
Max Fastening Torque Maksimum Tenaga Pemutaran Pengancing 最快扭力	170N-m (1,500in.lbs.)
Dimensions (L x W x H) Dimensi 体积	126x79x238mm (5"x3-1/8"x9-3/8")
Net Weight Berat Bersih 淨重	1.3 - 1.6kg (2.8 - 3.5lbs)
Work Amount (approx.) Jumlah Kerja 工作量	760 pcs with BL1850B Wood screw 65mm

DTD149RFE | **DTD149Z**
 RM 1,737 | RM 762

Cordless Impact Driver
 Pemutar Skru Impak Tanpa Kord
 充电式冲击螺丝起子机



- Developed for main applications such as tightening of self-drilling screws or light duty machine screws

Standard Equipment: Belt Clip

- RFE: 1x Rapid Charger, 2x 5.0Ah Battery
- Z: Without Charger, Battery & Carrying Case



Capacity Kapasiti 能力	Machine Screw: M4 - M8 (5/32" - 5/16") Standard Bolt: M5 - M14 (3/16" - 9/16") High Tensile Bolt: M5 - M12 (3/16" - 1/2") Coarse Thread (in length): 22 - 125mm (7/8" - 4-7/8") 6.35mm (1/4")
Hex Shank Batang Heksagon 六角柄	
No Load Speed (RPM) Kelajuan Tanpa Beban 回转数	0 - 2,500
Impacts Per Minute (IPM) Impak Per Minit 冲击数	0 - 3,200
Max Fastening Torque Maksimum Tenaga Pemutaran Pengancing 最快扭力	165N-m (1,460in.lbs.)
Dimensions (L x W x H) Dimensi 体积	135x79x238mm (5-5/16"x3-1/8"x9-3/8")
Net Weight Berat Bersih 淨重	1.3 - 1.6kg (2.8 - 3.5lbs)
Work Amount (approx.) Jumlah Kerja 工作量	533 pcs with BL1850B Wood screw ø4.3 x 65mm

DTD152RME | **DTD152RFE** | **DTD152Z**
 RM 1,902 | RM 1,737 | RM 762

Cordless Impact Driver
 Pemutar Skru Impak Tanpa Kord
 充电式冲击螺丝起子机



- Aluminum hammer case creates the impression of rigidity of the machine

Standard Equipment: Belt Clip

- RME: 1x Rapid Charger, 2x 4.0Ah Battery
- RFE: 1x Rapid Charger, 2x 3.0Ah Battery
- Z: Without Charger, Battery & Carrying Case



Capacity Kapasiti 能力	Machine Screw: M4 - M8 (5/32" - 5/16") Standard Bolt: M5 - M16 (3/16" - 5/8") High Tensile Bolt: M5 - M12 (3/16" - 1/2") Coarse Thread (in length): 22 - 125mm (7/8" - 4-7/8") 6.35mm (1/4")
Hex Shank Batang Heksagon 六角柄	
No Load Speed (RPM) Kelajuan Tanpa Beban 回转数	0 - 2,900
Impacts Per Minute (IPM) Impak Per Minit 冲击数	0 - 3,500
Max Fastening Torque Maksimum Tenaga Pemutaran Pengancing 最快扭力	165N-m (1,460 in.lbs.)
Dimensions (L x W x H) Dimensi 体积	137x79x238mm (5-3/8"x3-1/8"x9-3/8")
Net Weight Berat Bersih 淨重	1.3 - 1.6kg (2.8 - 3.5lbs)
Work Amount (approx.) Jumlah Kerja 工作量	603 pcs with BL1850B Hex screw 3/4" (Holding sheet 0.23mm RHS 1.6mm)

DTD156SF | **DTD156Z**
 RM 988 | RM 340

Cordless Impact Driver
 Pemutar Skru Impak Tanpa Kord
 充电式冲击螺丝起子机

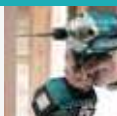

- Compact, lightweight but powerful 4-pole motor

Standard Equipment: Belt Clip

- SF: 1x Standard Charger, 1x 3.0Ah Battery
- Z: Without Charger, Battery & Carrying Case



Capacity Kapasiti 能力	Machine Screw: M4 - M8 (5/32" - 5/16") Standard Bolt: M5 - M14 (3/16" - 9/16") High Strength Bolt: M5 - M12 (3/16" - 1/2") Coarse Thread (in length): 22 - 125mm (7/8" - 4-7/8")
Hex Shank Batang Heksagon 六角柄	6.35mm (1/4")
No Load Speed (RPM) Kelajuan Tanpa Beban 回转数	0 - 2,500
Impacts Per Minute (IPM) Impak Per Minit 冲击数	0 - 3,000
Max Fastening Torque Maksimum Tenaga Pemutaran Pengancing 最快扭力	155N-m (1,370in.lbs.)
Dimensions (L x W x H) Dimensi 体积	143x79x241mm (5-5/8"x3-1/8"x9-1/2")
Net Weight Berat Bersih 淨重	1.3 - 1.6kg (2.9 - 3.6lbs.)

* All list price shown are for reference only (exclude SST).

* Semua harga yang ditunjukkan adalah untuk rujukan sahaja (tidak termasuk SST). 所有显示的建议零售价仅供参考 (不包括SST)。

Cordless Impact Driver
 LED Flashlight Lampu Suluh LED (LED/LED)
 Vacuum Cleaner Penapisulih Vakuum (Vacuum)
 Drilling / Fastening Bor / Pasang (Drill / Fasten)
 Impact Drilling / Demolition Galiul / Hancurkan (Impact Drill / Demolish)
 Cutting Pemotong (Cut)
 Grinding / Sanding Mengkilap / Haisul (Grind / Sand)
 Sawing Gergaji (Saw)
 Planing / Routing Menghalus / Tengam (Plane / Route)
 Others Lain-lain (Others)
 Outdoor Power Equipment Alatan Kuasa Luar (Outdoor Power Equipment)





Li-ion Ah 6.0 5.0 4.0 3.0 2.0 1.5

DTD155RME DTD155Z
RM 1,912 RM 773

Cordless Impact Driver
Pemutar Skru Impak Tanpa Kord
充电式冲击螺丝起子机



- 3-Mode operation for A-mode / Hard mode / Soft mode for multiple applications

Standard Equipment: Belt Clip

- RME: 1x Rapid Charger, 2x 4.0Ah Battery
- Z: Without Charger, Battery & Carrying Case



*Not applicable for Z model



Capacity Kapasiti 能力	Machine Screw: M4 - M8 mm (5/32" - 5/16") Standard Bolt: M5 - M14 (3/16" - 9/16") High Tensile Bolt: M5 - M12 (3/16" - 1/2") Coarse Thread (in length): 22 - 90mm (7/8" - 3-1/2") 6.35mm (1/4")
Hex Shank Batang Heksagon 六角柄	
No Load Speed (RPM) Kelajuan Tanpa Beban 回转速	Hard: 0 - 3,000 Soft: 0 - 1,300
Impacts Per Minute (IPM) Impak Per Minit 冲击数	Hard: 0 - 3,900 Soft: 0 - 1,600
Max Fastening Torque Maksimum Tenaga Pemutaran Pengancing 最快扭力	140N-m (1,240in.lbs.)
Dimensions (L x W x H) Dimensi 体积	135x79x232mm (5-5/16"x3-1/8"x9-1/8")
Net Weight Berat Bersih 淨重	1.2 - 1.5kg (2.6 - 3.2lbs)
Work Amount (approx.) Jumlah Kerja 工作量	725 pcs with BL1850B coarse thread screw 65mm (melapi)

DTP141RFE DTP141Z
RM 2,845 RM 1,868

Cordless 4 Mode Impact Driver
Pemutar Skru Impak Tanpa Kord
充电式冲击螺丝起子机



- 4 Operation Modes (Impact Driver, Hammer Drill, Drill, Screwdriver) and Teks Screw Mode selection

Standard Equipment: Belt Clip

- RFE: 1x Rapid Charger, 2x 3.0Ah Battery
- Z: Without Charger, Battery & Carrying Case



*Not applicable for Z model



Capacity Kapasiti 能力	Steel: 10mm (3/8") Wood: 21mm (13/16") Masonry: 8mm (5/16")
No Load Speed (RPM) Kelajuan Tanpa Beban 回转速	Impact-driver Mode: Hard: 0 - 2,700 Medium: 0 - 2,200 Soft: 0 - 1,300 Drill Mode High: 0 - 2,700 Low: 0 - 700 Hammer Drill Mode High: 0 - 2,700 Low: 0 - 700 Screwdriver Mode High: 0 - 1,100 Low: 0 - 300
Impacts Per Minute (IPM) Impak Per Minit 冲击数	Impact-driver Mode (Hard: 0-3,200 Medium: 0-2,400 Soft: 0-1,200) Hammer Drill Mode (Hi: 0 - 32,400 Lo: 0 - 8,400)
Max Fastening Torque Maksimum Tenaga Pemutaran Pengancing 最快扭力	Impact-driver Mode: 150N-m (1,330in.lbs.) Drill Mode (Hard/ Soft): 22/ 13N-m
Dimensions (L x W x H) Dimensi 体积	171x79x250mm (6-3/4"x3-1/8"x9-7/8")
Net Weight Berat Bersih 淨重	1.5 - 1.9kg (3.4 - 4.1lbs)

DTS141RFE DTS141Z
RM 3,183 RM 2,207

Cordless Oil-Pulse Driver
Pemutar Skru Impak Tanpa Kord
充电式冲击起子机



- Low noise level of 77dB

Standard Equipment: Belt Clip

- RFE: 1x Rapid Charger, 2x 3.0Ah Battery
- Z: Without Charger, Battery & Carrying Case



*Not applicable for Z model



VIDEO CLIP
Models and specs may vary by country

Capacity Kapasiti 能力	Machine Screw: M4 - M8 (5/32" - 5/16") Standard Bolt: M5 - M8 (3/16" - 5/16") High Tensile Bolt: M5 - M6 (3/16" - 1/4") Coarse Thread (in length): 22 - 125mm (7/8" - 4-7/8") Hard: 0-3,200 Medium: 0-2,000 Soft: 0-1,200
No Load Speed (RPM) Kelajuan Tanpa Beban 回转速	Hard: 0-2,700 Medium: 0-2,200 Soft: 0-1,400
Impacts Per Minute (IPM) Impak Per Minit 冲击数	Hard: 0-2,700 Medium: 0-2,200 Soft: 0-1,400
Max Fastening Torque Maksimum Tenaga Pemutaran Pengancing 最快扭力	40N-m (355in.lbs.)
Dimensions (L x W x H) Dimensi 体积	136x79x240mm (5-3/8"x3-1/8"x9-1/2")
Net Weight Berat Bersih 淨重	1.3 - 1.6kg (2.8 - 3.5lbs)
Work Amount (approx.) Jumlah Kerja 工作量	750 pcs with BL1850B Wood screw ø4.3 x 65mm

Model No. 型号	No Load Speed (rpm) Kelajuan Tanpa Beban 回转速	Impacts Per Minute (IPM) Impak Per Minit 冲击数	Electronic Speed Kelajuan Elektronik 电子速度	Max. Fastening Torque (N.m) Maksimum Tenaga Pemutaran Pengancing 最快扭转	Overall Length (mm) Panjang Keseluruhan 总长度	Net Weight Berat Bersih 淨重	BL MOTOR	XPT
Cordless Impact Driver								
DTD171	0 - 3,600/3,200/2,100/1,100/1,800/ 3,600/2,900/3,600	0 - 3,800/3,600/2,600/1,100/3,800/ 3,800/NA/2,600	4	180	116	1.2kg (2.7lbs)	●	●
DTD170	0 - 3,600/3,200/2,100/1,100/3,600	0 - 3,800/3,600/2,600/1,100/2,600	4	175	117	1.2kg (2.7lbs)	●	●
DTD154	0 - 3,600/0 - 2,100/0 - 1,100	0 - 3,800/0 - 2,600/0 - 1,100	3	175	117	1.3kg (2.7lbs)	●	●
DTD153	0 - 3,400	0 - 3,600	-	170	126	1.3kg (2.8lbs)	●	●
DTD149	0 - 2,500	0 - 3,200	-	165	135	1.3 kg (2.8lbs)	●	●
DTD152	0 - 2,900	0 - 3,500	-	165	137	1.3kg (2.8lbs)	●	●
DTD156	0 - 2,500	0 - 3,000	-	155	143	1.3kg (2.9lbs)	●	●
DTD155	0 - 3,000/0 - 1,300	0 - 3,900/0 - 1,600	2	140	135	1.2kg (2.6lbs)	●	●
Cordless 4 Mode Impact Driver (Impact-driver mode)								
DTP141	0-2,700/ 0-2,200/ 0-1,300	0-3,200/0-2,400/ 0-1,200	3	150	171	1.5kg (3.4lbs)	●	●
Cordless Oil-Pulse Drive								
DTS141	0-3,200/ 0-2,000/ 0-1,200	0-2,700/0-2,200/ 0-1,400	3	40	136	1.3kg (2.8lbs)	●	●

DTL061Z
RM 1,127

Cordless Angle Impact Driver
Pemutar Skru Impak Sudut
Tanpa Kord
充电式角冲击螺丝起子机



- 360 degrees rotatable head enables operation from optimum angle

Standard Equipment: Belt Clip

- Z: Without Charger & Battery



Capacity Kapasiti 能力	Machine Screw: M4 - M8 (5/32" - 5/16") Standard Bolt: M4 - M12 (5/32" - 1/2") High Tensile Bolt: M4 - M8 (5/32" - 5/16") Coarse Thread (in length): 22 - 75mm (7/8" - 2-31/32") 6.35mm (1/4")
Hex Shank Batang Heksagon 六角柄	
No Load Speed (RPM) Kelajuan Tanpa Beban 回转速	0 - 2,000
Impacts Per Minute (IPM) Impak Per Minit 冲击数	0 - 3,000
Max Fastening Torque Maksimum Tenaga Pemutaran Pengancing 最快扭力	60N-m (530in.lbs.)
Dimensions (L x W x H) Dimensi 体积	387x78x116mm (15-1/4"x3-1/16"x4-9/16")
Net Weight Berat Bersih 淨重	1.4 - 2.0kg (3.1 - 4.3lbs)
Work Amount (approx.) Jumlah Kerja 工作量	350 pcs with BL1850B Wood Screw 4.2 x 65mm

* All list price shown are for reference only (exclude SST).

* Semua harga yang ditunjukkan adalah untuk rujukan sahaja (tidak termasuk SST). 所有显示的建议零售价仅供参考 (不包括SST)。

Cordless
Tangkas Tanpa Kord

LED Flashlight
Lampu Sinar LED
LECOBRIGHT

Vacuum Cleaner
Penyedut Vakuum
ELECTRIC

Drilling / Fastening
Gruat / Pengancing
METS / 螺絲

Impact Drilling / Demolition
Gruat / Pencah
METS / 螺絲

Cutting
Pemotong
SATA

Grinding / Sanding
Pergilas / Meleh
METS / 螺絲

Sanding
Gruat
METS

Planing / Routing
Pegulas / Tangkapan
METS / 螺絲

Others
Lain-lain
METS

Outdoor Power Equipment
Alatan Kerja Luar
METS / 螺絲

Thakita
18V

18V

LXT

Li-ion Ah 6.0 5.0 4.0 3.0 2.0 1.5

Cordless
Tampal Kord Tanpa Kord
LED Flashlight
Lampu Suluh LED
LED NIGHT
Vacuum Cleaner
Penyedut Hiti Vakuum
BLUCC
Drilling / Fastening
Ganda / Penambah
GIGI / 螺絲
Impact Drilling / Demolition
Ganda / Penambah
GIGI / 螺絲 / 螺絲加工
Cutting
Pemotong
GIGI
Grinding / Sanding
Pengisar / Polish
GIGI / 螺絲
Sawing
Ganda
GIGI
Planing / Routing
Pengisar / Tangam
GIGI / 螺絲
Others
Lain-lain
GIGI
Outdoor Power Equipment
Alatan Kerja Luar
GIGI / 螺絲
Makita
19111

DDA351Z 10mm (3/8") RM 1,108 440

Cordless Angle Drill
Gerudi Sudut Tanpa Kord
充电式角向电钻



- Original 4-pole motor for power, lightweight and compact size

Standard Equipment: Side Grip

- Z: Without Charger & Battery



Capacity Kapasiti 能力	Steel: 10mm (3/8") Wood: 25mm (1")
No Load Speed (RPM) Kelajuan Tanpa Beban 回转速数	0-1,800
Dimensions (L x W x H) Dimensi 体积	326x79x115mm (12-7/8"x3-1/8"x4-1/2")
Net weight Berat Bersih 淨重	1.6 - 1.9kg (4.2 - 3.5lbs)
Work Amount (approx.) Jumlah Kerja 工作量	1000 pcs with BL1850B Wood Screw ø5.1 x 38mm

DFS452Z RM 1,427

Cordless Screwdriver
Pemutar Skru Tanpa Kord
充电式螺丝起子机



- Push Drive Technology for Quieter Operation; Minimizes Power Consumption

Standard Equipment: Phillips Bit, Magnetic Bit Holder, Belt Clip

- Z: Without Charger & Battery



Capacity Kapasiti 能力	Self-Drilling Screw: 6mm (1/4") Drywall Screw: 5mm (3/16") 6.35mm (1/4")
Driving Shank (Hex) Hex Memandu Aci 六角驱动轴	
No Load Speed (RPM) Kelajuan Tanpa Beban 回转速数	0 - 4,000
Dimensions (L x W x H) Dimensi 体积	251x79x259mm (10"x3-1/8"x11-1/4")
Net weight Berat Bersih 淨重	1.5 - 1.8kg (3.2 - 3.9lbs)
Work Amount (approx.) Jumlah Kerja 工作量	2325 pcs with BL1850B Wood Screw 1.0 x 32mm

DFS250RTE RM 2,553 | **DFS250RFE** RM 2,243 | **DFS250Z** RM 1,270

Cordless Screwdriver
Pemutar Skru Tanpa Kord
充电式螺丝起子机



- Ultra-high efficiency comparable to AC screwdrivers

Standard Equipment: Phillips Bit, Magnetic Bit Holder, Belt Clip

- RTE: 1x Rapid Charger, 2x 5.0Ah Battery
- RFE: 1x Rapid Charger, 2x 3.0Ah Battery
- Z: Without Charger, Battery & Carrying Case

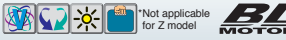

Capacity Kapasiti 能力	Coarse Thread: 4.5 x 90mm (3/16" x 3-1/2") Self-Drilling Screw: 6mm (1/4") Drywall Screw: 5mm (3/16") 6.35mm (1/4")
Driving Shank (Hex) Hex Memandu Aci 六角驱动轴	
No Load Speed (RPM) Kelajuan Tanpa Beban 回转速数	0 - 2,500
Dimensions (L x W x H) Dimensi 体积	259x79x259mm (10-1/4"x3-1/8"x10-1/4")
Net weight Berat Bersih 淨重	1.5 - 1.9kg (3.4 - 4.1lbs)
Work Amount (approx.) Jumlah Kerja 工作量	1091 pcs with BL1850B Wood Screw 8" x 1" (Pine Wood)

DFS251RTE RM 2,553 | **DFS251RFE** RM 2,243 | **DFS251Z** RM 1,270

Cordless Screwdriver
Pemutar Skru Tanpa Kord
充电式螺丝起子机



- High torque ideal for fastening self-drilling screw

Standard Equipment: Magnetic Socket Bit, Belt Clip

- RTE: 1x Rapid Charger, 2x 5.0Ah Battery
- RFE: 1x Rapid Charger, 2x 3.0Ah Battery
- Z: Without Charger, Battery & Carrying Case

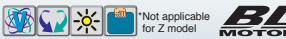

Capacity Kapasiti 能力	Self-Drilling Screw: 6mm (1/4") Drywall Screw: 5mm (3/16") Hex Socket Screw: 6mm (1/4")
Driving Shank (Hex) Hex Memandu Aci 六角驱动轴	6.35mm (1/4")
No Load Speed (RPM) Kelajuan Tanpa Beban 回转速数	0 - 2,500
Dimensions (L x W x H) Dimensi 体积	237x79x259mm (9-3/8"x3-1/8"x11-1/4")
Net weight Berat Bersih 淨重	1.5 - 1.8kg (3.2 - 3.9lbs)
Work Amount (approx.) Jumlah Kerja 工作量	1091 pcs with BL1850B Wood Screw 8" x 1" (Pine Wood)

DFR550Z RM 1,452 440

Cordless Auto Feed Screwdriver
Pemutar Skru Suapan Auto Tanpa Kord
充电式自动螺丝起子机



- Ideal for drywall and subfloors

Standard Equipment: Phillips Bit x3

- Z: Without Charger & Battery



Screw Strip Kapasiti 能力	4 x 25 - 55mm (5/32" x 1" - 2-3/16")
Driving Shank (Hex) Hex Memandu Aci 六角驱动轴	6.35mm (1/4")
No Load Speed (RPM) Kelajuan Tanpa Beban 回转速数	4,000
Dimensions (L x W x H) Dimensi 体积	424x80x238mm (16-3/4"x3-1/8"x9-3/8")
Net weight Berat Bersih 淨重	2.1 - 3.1kg (4.6 - 6.9lbs)
Work Amount (approx.) Jumlah Kerja 工作量	1166 pcs with BL1850B Wood Screw 35mm (1-3/8") (plasterboard into Douglas-fir timber)

* All list price shown are for reference only (exclude SST).

* Semua harga yang ditunjukkan adalah untuk rujukan sahaja (tidak termasuk SST). 所有显示的建议零售价仅供参考 (不包括SST)。

BRUSHLESS MOTOR

Motor tanpa berus 无碳刷马达

- Maintenance-free due to no brush
 - Life time work amount of a battery is increased
 - Durable against long continuous operation
 - More work amount on a single full battery charge
- 免却更换碳刷的高频工序，保养轻松简单
采用BL无碳刷马达的工具没有因摩擦热导致的能量流失，
所以每次充电后的连续工作时间更长



BRUSHED MOTOR

Motor dengan berus 有刷马达

- High power-to-weight ratio obtained by employing 4-pole motor
- Berkuasa tinggi dengan motor 4-pole
采用4极马达，高功率

4-POLE MOTOR

2-POLE MOTOR



Max Fastening Torque

Maksimum Tenaga Pemutaran Pengancing 最大扭矩



* All list price shown are for reference only (exclude SST).

* Semua harga yang ditunjukkan adalah untuk rujukan sahaja (tidak termasuk SST). 所有显示的建议零售价仅供参考 (不包括SST)。

Cordless
Tangan-tangan
LED Flashlight
Lampu Sinar LED
LECOBET
Vacuum Cleaner
Penyedut Vakum
ELECT
Drilling / Fastening
Gruel / Pengancing
METS / 螺絲
Impact Drilling / Demolition
Gruel / Penanggalan
METS / 螺絲
Cutting
Pemotong
SMA
Grinding / Sanding
Pergasil / Pencil
METS / 螺絲
Sawing
Gugil
METS
Planing / Routing
Pegilahan / Tangan
METS / 螺絲
Others
Lain-lain
METS
Outdoor Power Equipment
Alatan Kuasa Luar
METS / 螺絲
Thakita
METS



Li-ion Ah 6.0 | 5.0 | 4.0 | 3.0 | 2.0 | 1.5

DTW1001RTJ RM 3,542 | **DTW1001RMJ** RM 3,397 | **DTW1001RFJ** RM 3,232 | **DTW1001Z** 19mm (3/4") RM 2,257

Cordless Impact Wrench
Perengkuh Impak Tanpa Kord
充电式冲击套筒扳手



VIDEO CLIP
Models and specs may vary by country



• Makita's Most Powerful Impact Wrench

Standard Equipment: Hook

- RTJ: 1x Rapid Charger, 2x 5.0Ah Battery, 1x Makpac Connector Box
- RMJ: 1x Rapid Charger, 2x 4.0Ah Battery, 1x Makpac Connector Box
- RFJ: 1x Rapid Charger, 2x 3.0Ah Battery, 1x Makpac Connector Box
- Z: Without Charger, Battery & Carrying Case

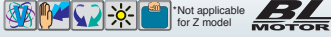

Fastening Capacities Kapasiti 能力	Standard Bolt: M12 - M30 (1/2" - 1-1/4") High Tensile Bolt: M10 - M24 (3/8" - 1") 19mm (3/4")
Square Drive Skrus Persegi 方形螺栓	
No Load Speed (RPM) Kelajuan Tanpa Beban 回转数	Hard: 0 - 1,800 Medium: 0 - 1,000 Soft: 0 - 900
Impacts Per Minute (IPM) Impak Per Minit 冲击数	Hard: 0 - 2,200 Medium: 0 - 2,000 Soft: 0 - 1,800
Max Fastening Torque Pemutaran Tenaga Maksimum 最大扭矩	1,050N-m (780ft.lbs.)
Dimensions (L x W x H) Dimensi 体积	229x91x289mm (9"x3-5/8"x11-3/8")
Net Weight Berat Bersih 淨重	3.4 - 3.7kg (7.5 - 8.2lbs)
Work Amount (approx.) Jumlah Kerja 工作量	185 pcs with BL1850B Bolts M20

DTW1002RTJ RM 3,457 | **DTW1002RMJ** RM 3,312 | **DTW1002RFJ** RM 3,147 | **DTW1002Z** 12.7mm (1/2") RM 2,172

Cordless Impact Wrench
Perengkuh Impak Tanpa Kord
充电式冲击套筒扳手



• Efficient impact system (Max 2,200 IPM) with less vibration

Standard Equipment: Hook

- RTJ: 1x Rapid Charger, 2x 5.0Ah Battery, 1x Makpac Connector Box
- RMJ: 1x Rapid Charger, 2x 4.0Ah Battery, 1x Makpac Connector Box
- RFJ: 1x Rapid Charger, 2x 3.0Ah Battery, 1x Makpac Connector Box
- Z: Without Charger, Battery & Carrying Case

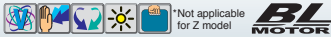

Fastening Capacities Kapasiti 能力	Standard Bolt: M12 - M30 (1/2" - 1-1/4") High Tensile Bolt: M10 - M24 (3/8" - 1") 12.7mm (1/2")
Square Drive Skrus Persegi 方形螺栓	
No Load Speed (RPM) Kelajuan Tanpa Beban 回转数	Hard: 0 - 1,800 Medium: 0 - 1,000 Soft: 0 - 900
Impacts Per Minute (IPM) Impak Per Minit 冲击数	Hard: 0 - 2,200 Medium: 0 - 2,000 Soft: 0 - 1,800
Max Fastening Torque Pemutaran Tenaga Maksimum 最大扭矩	1,000N-m (740ft.lbs.)
Dimensions (L x W x H) Dimensi 体积	229x91x289mm (9"x3-5/8"x11-3/8")
Net Weight Berat Bersih 淨重	3.3 - 3.6kg (7.3 - 8.0lbs)
Work Amount (approx.) Jumlah Kerja 工作量	185 pcs with BL1850B Bolts M20

DTW800RMJ RM 3,338 | **DTW800RFJ** RM 3,173 | **DTW800Z** 11.2mm (7/16") RM 2,198

Cordless Impact Wrench
Perengkuh Impak Tanpa Kord
充电式冲击套筒扳手

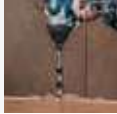

• Extremely high power 800N-m (590ft.lbs.) way ahead of competitors

Standard Equipment: Hook

- RMJ: 1x Rapid Charger, 2x 4.0Ah Battery, 1x Makpac Connector Box
- RFJ: 1x Rapid Charger, 2x 3.0Ah Battery, 1x Makpac Connector Box
- Z: Without Charger, Battery & Carrying Case

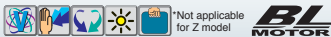

Fastening Capacities Kapasiti 能力	Standard Bolt: M12 - M24 (1/2" - 1") High Tensile Bolt: M10 - M22 (3/8" - 7/8") 11.1mm (7/16")
Hex Shank Skrus Persegi 方形螺栓	
No Load Speed (RPM) Kelajuan Tanpa Beban 回转数	Hard: 0 - 1,800 Medium: 0 - 1,000 Soft: 0 - 900
Impacts Per Minute (IPM) Impak Per Minit 冲击数	Hard: 0 - 2,200 Medium: 0 - 2,000 Soft: 0 - 1,800
Max Fastening Torque Pemutaran Tenaga Maksimum 最大扭矩	800N-m (590ft.lbs.)
Dimensions (L x W x H) Dimensi 体积	229x91x303mm (9"x3-5/8"x11-7/8")
Net Weight Berat Bersih 淨重	3.4 - 3.7kg (8.2 - 7.5lbs)
Work Amount (approx.) Jumlah Kerja 工作量	27 holes with BL1850B Auger Drill ø13/16" (Drill 300mm Douglas-fir)

DTW450RME RM 2,353 | **DTW450RFE** RM 2,190 | **DTW450Z** 12.7mm (1/2") RM 1,215

Cordless Impact Wrench
Perengkuh Impak Tanpa Kord
充电式冲击套筒扳手



• Compact and lightweight design provide superior balance and control

Standard Equipment: Hook

- RME: 1x Rapid Charger, 2x 4.0Ah Battery
- RFE: 1x Rapid Charger, 2x 3.0Ah Battery
- Z: Without Charger, Battery & Carrying Case



Fastening Capacities Kapasiti 能力	Standard Bolt: M12 - M22 (1/2" - 7/8") High Tensile Bolt: M12 - M16 (1/2" - 5/8") 12.7mm (1/2")
Square Drive Skrus Persegi 方形螺栓	
No Load Speed (RPM) Kelajuan Tanpa Beban 回转数	1,600
Impacts Per Minute (IPM) Impak Per Minit 冲击数	2,200
Max Fastening Torque Pemutaran Tenaga Maksimum 最大扭矩	440N-m (325 ft.lbs.)
Dimensions (L x W x H) Dimensi 体积	266x82x290mm (10-1/2"x3-1/4"x11-3/8")
Net Weight Berat Bersih 淨重	3.1 - 3.4kg (7.6 - 6.9lbs)
Work Amount (approx.) Jumlah Kerja 工作量	120 pcs with BL1850B Bolts M16

DTW285RME RM 2,457 | **DTW285RFE** RM 2,293 | **DTW285Z** 12.7mm (1/2") RM 1,318

Cordless Impact Wrench
Perengkuh Impak Tanpa Kord
充电式冲击套筒扳手



Reverse Rotation Auto Stop Mode
Mod auto berhenti untuk putaran terbalik 反转自动停止模式



• BL motor delivers 280N-m of max torque

Standard Equipment: Belt Clip

- RME: 1x Rapid Charger, 2x 4.0Ah Battery
- RFE: 1x Rapid Charger, 2x 3.0Ah Battery
- Z: Without Charger, Battery & Carrying Case



Fastening Capacities Kapasiti 能力	Standard Bolt: M10 - M20 (3/8" - 3/4") High Tensile Bolt: M10 - M16 (3/8" - 5/8") 12.7mm (1/2")
Square Drive Skrus Persegi 方形螺栓	
No Load Speed (RPM) Kelajuan Tanpa Beban 回转数	Hard: 0 - 2,800 Medium: 0 - 2,100 Soft: 0 - 1,600
Impacts Per Minute (IPM) Impak Per Minit 冲击数	Hard: 0 - 3,500 Medium: 0 - 2,600 Soft: 0 - 1,800
Max Fastening Torque Pemutaran Tenaga Maksimum 最大扭矩	280N-m (210ft.lbs.)
Dimensions (L x W x H) Dimensi 体积	147x79x249mm (5-3/4"x3-1/8"x9-3/4")
Net Weight Berat Bersih 淨重	1.5 - 1.8kg (3.2 - 3.9lbs)
Work Amount (approx.) Jumlah Kerja 工作量	275 pcs with BL1850B High Tensile Bolt M16

* All list price shown are for reference only (exclude SST).

* Semua harga yang ditunjukkan adalah untuk rujukan sahaja (tidak termasuk SST). 所有显示的建议零售价仅供参考 (不包括SST)。

Cordless Impact Wrench
LED Flashlight Lampu Suluh LED (LED/LED)
Vacuum Cleaner Penapisan Vakuum (Penapisan Vakuum)
Drilling / Fastening Bor / Pasang (Bor / Pasang)
Impact Drilling / Demolition Bor / Hancurkan (Bor / Hancurkan)
Cutting Pemotong (Pemotong)
Grinding / Sanding Mengkilap / Hiruskan (Mengkilap / Hiruskan)
Sawing Gergaji (Gergaji)
Planing / Routing Penghalus / Tengking (Penghalus / Tengking)
Others Lain-lain (Lain-lain)
Outdoor Power Equipment Alatan Kuasa Luar (Alatan Kuasa Luar)





Li-ion Ah 6.0 5.0 4.0 3.0 2.0 1.5

DTW251RME DTW251RFE DTW251Z 12.7mm (1/2") 448mm

Cordless Impact Wrench
Perengkuh Impak Tanpa Kord
充电式冲击套筒扳手



- High power, compact and lightweight 4-pole motor

Standard Equipment: Belt Clip

- RME: 1x Rapid Charger, 2x 4.0Ah Battery
- RFE: 1x Rapid Charger, 2x 3.0Ah Battery
- Z: Without Charger, Battery & Carrying Case



DTW181RFE DTW181Z 12.7mm (1/2")

Cordless Impact Wrench
Perengkuh Impak Tanpa Kord
充电式冲击套筒扳手



- Ideal for working in tight spaces

Standard Equipment: Belt Clip

- RFE: 1x Rapid Charger, 2x 3.0Ah Battery
- Z: Without Charger, Battery & Carrying Case



DTW180Z 9.5mm (3/8")

Cordless Impact Wrench
Perengkuh Impak Tanpa Kord
充电式冲击套筒扳手



- Ideal for working in tight spaces

Standard Equipment: Belt Clip

- Z: Without Charger & Battery



DTW190RME DTW190RFE DTW190Z 12.7mm (1/2")

Cordless Impact Wrench
Perengkuh Impak Tanpa Kord
充电式冲击套筒扳手



- 190N-m (140ft.lbs.) of Max torque optimal for scaffold building

- RME: 1x Rapid Charger, 2x 4.0Ah Battery
- RFE: 1x Rapid Charger, 2x 3.0Ah Battery
- Z: Without Charger, Battery & Carrying Case



Fastening Capacities Kapasiti 能力	Standard Bolt: M10 - M16 (3/8" - 5/8") High Tensile Bolt: M10 - M14 (3/8" - 9/16") 12.7mm (1/2")
Square Drive Skrü Persegi 方形螺柱	
No Load Speed (RPM) Kelajuan Tanpa Beban 回转数	0 - 2,100
Impacts Per Minute (IPM) Impak Per Minit 冲击数	0 - 3,200
Max Fastening Torque Pemutaran Tenaga Maksimum 最大扭矩	230N-m (170ft.lbs.)
Dimensions (L x W x H) Dimensi 体积	165x79x234mm (6-1/2"x3-1/8"x9-1/4")
Net Weight Berat Bersih 淨重	1.5 - 1.8kg (3.2 - 3.9lbs)
Work Amount (approx.) Jumlah Kerja 工作量	250 pcs with BL1850B Bolt M14

Fastening Capacities Kapasiti 能力	Standard Bolt: M8 - M16 (5/16" - 5/8") High Strength Bolt: M6 - M12 (1/4" - 1/2") 12.7 mm (1/2")
Square Drive Skrü Persegi 方形螺柱	
No Load Speed (RPM) Kelajuan Tanpa Beban 回转数	Hard: 0 - 2,400 Soft: 0 - 1,300
Impacts Per Minute (IPM) Impak Per Minit 冲击数	Hard: 0 - 3,600 Soft: 0 - 2,000
Max Fastening Torque Pemutaran Tenaga Maksimum 最大扭矩	210N-m (155ft.lbs.)
Dimensions (L x W x H) Dimensi 体积	151x79x235mm (5-15/16"x3-1/8"x9-1/4")
Net Weight Berat Bersih 淨重	1.2 - 1.5kg (2.7 - 3.4lbs.)

Fastening Capacities Kapasiti 能力	Standard Bolt: M8 - M16 (5/16" - 5/8") High Tensile Bolt: M6 - M12 (1/4" - 1/2") 9.5 mm (3/8")
Square Drive Skrü Persegi 方形螺柱	
No Load Speed (RPM) Kelajuan Tanpa Beban 回转数	Hard: 0 - 2,400 Soft: 0 - 1,300
Impacts Per Minute (IPM) Impak Per Minit 冲击数	Hard: 0 - 3,600 Soft: 0 - 2,000
Max Fastening Torque Pemutaran Tenaga Maksimum 最大扭矩	180N-m (130ft.lbs.)
Dimensions (L x W x H) Dimensi 体积	144x79x235mm (5-5/8"x3-1/8"x9-1/4")
Net Weight Berat Bersih 淨重	1.2 - 1.5kg (2.7 - 3.4lbs.)

Fastening Capacities Kapasiti 能力	Standard Bolt: M8 - M16 (5/16" - 5/8") High Tensile Bolt: M8 - M12 (5/16" - 1/2") 12.7mm (1/2")
Square Drive Skrü Persegi 方形螺柱	
No Load Speed (RPM) Kelajuan Tanpa Beban 回转数	0 - 2,300
Impacts Per Minute (IPM) Impak Per Minit 冲击数	0 - 3,000
Max Fastening Torque Pemutaran Tenaga Maksimum 最大扭矩	190N-m (140ft.lbs.)
Overall Length Dimensi 体积	176mm (6-15/16")
Net Weight Berat Bersih 淨重	1.4 - 1.8kg (3.2 - 3.9lbs)

Model No. 型号	Square Drive Skrü Pemacu Persegi 方形传动螺柱	No Load Speed (rpm) Kelajuan Tanpa Beban 回转数	Impacts Per Minute (IPM) Impak Per Minit 冲击数	Max. Fastening Torque (N.m) Maksimum Tenaga Pemutaran Pengancing 最大扭矩	Overall Length (mm) Panjang Keseluruhan 总长度	Net Weight Berat Bersih 淨重	BL MOTOR	XPT
Cordless Impact Wrench								
DTW1001	19mm (3/4")	0-1,800 / 0-1,000 / 0-900	0 - 2,200 / 0 - 2,000 / 0 - 1,800	1,050 (780ft.lbs.)	229	3.4kg (7.5lbs)	●	
DTW1002	12.7mm (1/2")	0-1,800 / 0-1,000 / 0-900	0 - 2,200 / 0 - 2,000 / 0 - 1,800	1,000 (740ft.lbs.)	229	3.3kg (7.3lbs)	●	
DTW800	11.2mm (7/16") Hex.	0-1,800 / 0-1,000 / 0-900	0 - 2,200 / 0 - 2,000 / 0 - 1,800	800 (590ft.lbs.)	229	3.4kg (8.2lbs)	●	
DTW450	12.7mm (1/2")	1,600	2,200	440 (325ft.lbs.)	266	3.1kg (7.6lbs)		
DTW285	12.7mm (1/2")	0-2,800 / 0-2,100 / 1,600	0 - 3,500 / 0 - 2,600 / 0 - 1,800	280 (210ft.lbs.)	147	1.5kg (3.2lbs)	●	●
DTW251	12.7mm (1/2")	0-2,100	0 - 3,200	230 (170ft.lbs.)	165	1.5kg (3.2lbs)		
DTW181	12.7mm (1/2")	0-2,400 / 0-1,300	0 - 3,600 / 0-2,000	210 (155ft.lbs.)	151	1.2kg (2.7lbs)	●	●
DTW180	9.5mm (3/8")	0-2,400 / 0-1,300	0 - 3,600 / 0-2,000	180 (130ft.lbs.)	144	1.2kg (2.7lbs)	●	●
DTW190	12.7mm (1/2")	0-2,300	0 - 3,000	190 (140ft.lbs.)	176	1.4kg (3.2lbs)		

* All list price shown are for reference only (exclude SST).

* Semua harga yang ditunjukkan adalah untuk rujukan sahaja (tidak termasuk SST). 所有显示的建议零售价仅供参考 (不包括SST)。

Cordless
Tanpa Kord / 充电式

LED Flashlight
Lampu Cahaya LED
LED照明灯

Vacuum Cleaner
Penyedut Vakuum
吸尘器

Drilling / Fastening
Cairul / Pascah
钻孔 / 紧固

Impact Drilling / Demolition
Cairul / Pascah
冲击钻孔 / 拆除

Cutting
Pemotong
切割

Grinding / Sanding
Pergasil / Pascah
磨削 / 打磨

Sawing
Gajul
锯切

Planing / Routing
Pegulangan / Tanggapan
刨平 / 铣削

Others
Lain-lain
其他

Outdoor Power Equipment
Alatan Kuat Unit
户外动力设备





Li-ion Ah 6.0 5.0 4.0 3.0 2.0 1.5

DTL063Z 9.5mm (3/8")
RM 1,218

Cordless Angle Impact Wrench
Perengkuh Impak Sudut Tanpa Kord
充电式角向冲击套筒扳手



- Compact angle head for easy access to bolts in tight places



Standard Equipment: Belt Clip

- Z: Without Charger & Battery



Fastening Capacities Kapasiti 能力	Standard Bolt: M4 - M12 (5/32" - 1/2")
Square Drive Skrus Persegi 方形螺柱	High Tensile Bolt: M4 - M8 (5/32" - 5/16") 9.5mm (3/8")
No Load Speed (RPM) Kelajuan Tanpa Beban 回转数	0 - 2,000
Impacts Per Minute (IPM) Impak Per Minit 冲击数	0 - 3,000
Max Fastening Torque Pemutaran Tenaga Maksimum 最大扭矩	60N-m (N/A ft.lbs.)
Dimensions (L x W x H) Dimensi 体积	387x78x116mm (15-1/4"x3-1/16"x4-9/16")
Net Weight Berat Bersih 淨重	1.4 - 2.0kg (3.1 - 4.3lbs)

DHR242RTE | **DHR242RME** | **DHR242RFE** | **DHR242Z** 24mm (15/16")
RM 2,745 | RM 2,600 | RM 2,437 | RM 1,460

Cordless Combination Hammer
Tukul Kombinasi Tanpa Kord
充电式冲击电钻电锤



- 3-Mode operation; rotation only, hammering with rotation and hammering only



Standard Equipment: Depth Gauge, Side Grip

- RTE: 1x Rapid Charger, 2x 5.0Ah Battery
- RME: 1x Rapid Charger, 2x 4.0Ah Battery
- RFE: 1x Rapid Charger, 2x 3.0Ah Battery
- Z: Without Charger, Battery & Carrying Case



*Not applicable for Z model



Impact Energy Kekuatan Impak 单次最大冲击力	2J
Capacity Kapasiti 能力	Concrete: 24mm (15/16") Steel: 13mm (1/2") Wood: 27mm (1-1/16")
Impacts Per Minute (IPM) Impak Per Minit 冲击数	0 - 4,700
No Load Speed (RPM) Kelajuan Tanpa Beban 回转数	0 - 950
Dimensions (L x W x H) Dimensi 体积	328x85x213mm (12-7/8"x3-3/8"x8-3/8")
Net Weight Berat Bersih 淨重	3.1 - 3.8kg (6.7 - 8.4lbs)
Work Amount (approx.) Jumlah Kerja 工作量	60 holes with BL1850B Masonry Drill ø10.5mm Concrete Depth 60mm

DHR241RFE | **DHR241Z** 20mm (13/16")
RM 2,017 | RM 1,040

Cordless Combination Hammer
Tukul Kombinasi Tanpa Kord
充电式冲击电钻电锤

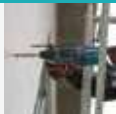

- 3-Mode operation; rotation only, hammering with rotation and hammering only



Standard Equipment: Depth Gauge, Side Grip

- RFE: 1x Rapid Charger, 2x 3.0Ah Battery
- Z: Without Charger, Battery & Carrying Case



*Not applicable for Z model



Impact Energy Kekuatan Impak 单次最大冲击力	1.9J
Capacity Kapasiti 能力	Concrete: 20mm (13/16") Steel: 13mm (1/2") Wood: 26mm (1")
Impacts Per Minute (IPM) Impak Per Minit 冲击数	0 - 4,000
No Load Speed (RPM) Kelajuan Tanpa Beban 回转数	0 - 1,100
Dimensions (L x W x H) Dimensi 体积	417x84x219mm (16-3/8"x3-5/16"x8-5/8")
Net Weight Berat Bersih 淨重	3.2 - 4.0kg (7.1 - 8.8lbs)
Work Amount (approx.) Jumlah Kerja 工作量	133 holes with BL1850B Masonry drill ø16.5mm Concrete Depth 40mm

DHR202RME | **DHR202RFE** | **DHR202Z** 20mm (13/16")
RM 2,235 | RM 2,072 | RM 1,095

Cordless Combination Hammer
Tukul Kombinasi Tanpa Kord
充电式冲击电钻电锤

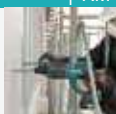

- 3-Mode operation; rotation only, hammering with rotation and hammering only



Standard Equipment: Depth Gauge, Side Grip

- RME: 1x Rapid Charger, 2x 4.0Ah Battery
- RFE: 1x Rapid Charger, 2x 3.0Ah Battery
- Z: Without Charger, Battery & Carrying Case



*Not applicable for Z model



Capacity Kapasiti 能力	Concrete: 20mm (13/16") Steel: 13mm (1/2") Wood: 26mm (1")
Impacts Per Minute (IPM) Impak Per Minit 冲击数	0 - 4,000
No Load Speed (RPM) Kelajuan Tanpa Beban 回转数	0 - 1,100
Dimensions (L x W x H) Dimensi 体积	358x84x259mm (14-1/8"x3-5/16"x10-1/4")
Net Weight Berat Bersih 淨重	3.2 - 4.0kg (7.1 - 8.8lbs)
Work Amount (approx.) Jumlah Kerja 工作量	130 holes with BL1850B Masonry drill ø6.5mm Concrete Depth 60mm

DHR182ZWJ 18mm (11/16")
RM 1,957

Cordless Combination Hammer
Tukul Kombinasi Tanpa Kord
充电式冲击电钻电锤



- Auto-start Wireless System (AWS) connects to vacuum cleaner with Bluetooth



Standard Equipment: Side Grip, Depth Gauge

- ZWJ: Without Charger, Battery, Come with 1x Dust Extraction System Set, 1x Makpac Connector Box



*Not applicable for Z model



Impact Energy Kekuatan Impak 单次最大冲击力	EPTA-Procedure 05/2009: 1.7J Our experimental conditions: 1.6J
Capacity Kapasiti 能力	Concrete: 18mm (11/16") Core Bit: 35mm (1-3/8") Diamond Core Bit (Dry Type): 32mm (1-1/4") Steel: 13mm (1/2") Wood: 24mm (15/16")
Impacts Per Minute (IPM) Impak Per Minit 冲击数	0 - 5,000
No Load Speed (RPM) Kelajuan Tanpa Beban 回转数	0 - 1,350
Max Output Keluaran Maksima 最大输出	450W
Dimensions (L x W x H) Dimensi 体积	301x82x285mm (11-7/8"x3-1/4"x11-1/4")
Net Weight Berat Bersih 淨重	2.4 - 3.2kg (5.3 - 7.0lbs.)

* All list price shown are for reference only (exclude SST).

* Semua harga yang ditunjukkan adalah untuk rujukan sahaja (tidak termasuk SST). 所有显示的建议零售价仅供参考 (不包括SST)。

Cordless Impact Driver
LED Flashlight Lampu Suluh LED
Vacuum Cleaner Penapisan Vakuum
Drilling / Fastening
Impact Drilling / Demolition
Cutting
Grinding / Sanding
Sawing
Planing / Routing
Others
Outdoor Power Equipment



18V

LXT

Li-ion Ah 6.0 5.0 4.0 3.0 2.0 1.5

DHR171RTE RM 2,343 | **DHR171RFE** RM 2,035 | **DHR171Z** 17mm (11/16") RM 1,060

Cordless Rotary Hammer
Tukul Putar Tanpa Kord
充电式电锤



- 2-Mode operation; rotation only, or hammering with rotation only

Standard Equipment: Side Grip, Depth Gauge

- RTE: 1x Rapid Charger, 2x 5.0Ah Battery
- RFE: 1x Rapid Charger, 2x 3.0Ah Battery
- Z: Without Charger, Battery & Carrying Case



Impact Energy Kekuatan Impak 单次最大锤击力	EPTA-Procedure 05/2009: 1.2J Our experimental conditions: 1.1J
Capacity Kapasiti 能力	Concrete: 17mm (11/16") Steel: 10mm (3/8") Wood: 13mm (1/2")
Impacts Per Minute (IPM) Impak Per Minit 冲击数	0 - 4,800
No Load Speed (RPM) Kelajuan Tanpa Beban 回转数	0 - 680
Dimensions (L x W x H) Dimensi 体积	273x86x211mm (10-3/4"x3-3/8"x8-5/16")
Net Weight Berat Bersih 净重	2.1 - 2.8kg (4.6 - 6.2lbs)
Work Amount (approx.) Jumlah Kerja 工作量	220 holes with BL1850B Masonry Drill Ø6mm Concrete 40N/mm2 Depth 40mm

DHR165RME RM 2,130 | **DHR165RFE** RM 1,965 | **DHR165Z** 16mm (5/8") RM 990 430 Wh

Cordless Rotary Hammer
Tukul Putar Tanpa Kord
充电式电锤



- 2-Mode operation; rotation only, or hammering with rotation only

Standard Equipment: Depth Gauge, Side Grip

- RME: 1x Rapid Charger, 2x 4.0Ah Battery
- RFE: 1x Rapid Charger, 2x 3.0Ah Battery
- Z: Without Charger, Battery & Carrying Case



Impact Energy Kekuatan Impak 单次最大锤击力	1.3J
Capacity Kapasiti 能力	Concrete: 16mm (5/8") Steel: 13mm (1/2") Wood: 24mm (15/16")
Impacts Per Minute (IPM) Impak Per Minit 冲击数	0 - 5,300
No Load Speed (RPM) Kelajuan Tanpa Beban 回转数	0-1,600
Dimensions (L x W x H) Dimensi 体积	297x79x253mm (11-3/4"x3-1/8"x10")
Net Weight Berat Bersih 净重	2.3 - 3.0kg (5.0 - 6.6lbs)
Work Amount (approx.) Jumlah Kerja 工作量	225 holes with BL1850B Masonry drill ø6.5mm Concrete Depth 30mm

Cordless Power Scraper

Pengikis Kuasa Tanpa Kord 充电式刮板



Slide lever for trigger lock-on/ lock-off
Tuas gelongsor untuk kunci pencetus
滑动杆用于扳机锁定



Twin LED job light
Lampu kerja LED
双LED工作灯



Variable speed control by dial
Kawalan kelajuan 变速控制



Vibration Level
Tahap Getaran 振动等级

4.5m/s²

Impact Energy
Kekuatan Impak
单次最大锤击力

3.1J

DHK180Z RM 3,400

Cordless Power Scraper
Pengikis Kuasa Tanpa Kord
充电式刮板



- High power & low vibration

Standard Equipment: Hook

- Z: Without Charger, Battery & Carrying Case



Impact Energy Kekuatan Impak 单次最大锤击力	EPTA-Procedure 05/2009: 3.1J Our experimental conditions: 3.9J
Impact Per Minute (IPM) Impak Per Minit 冲击数	0 - 3,200
Dimensions (L x W x H) Dimensi 体积	368x99x211mm (14-1/2"x3-7/8"x8-5/16")
Net Weight Berat Bersih 净重	3.3 - 3.6 kg (7.3 - 7.9 lbs.)
Continuous Usage Time (approx.) Masa Penggunaan Berterusan 连续使用时间	17min with BL1850B



* All list price shown are for reference only (exclude SST).

* Semua harga yang ditunjukkan adalah untuk rujukan sahaja (tidak termasuk SST). 所有显示的建议零售价仅供参考 (不包括SST)。

Cordless
Tanpa Kord / 充电式

LED Flashlight
Lampu Cahaya LED
LED工作灯

Vacuum Cleaner
Penarik Debu / 吸尘器

Drilling / Fastening
Guaian / Pasak
钻孔 / 固定

Impact Drilling / Demolition
Guaian / Pasak
钻孔 / 拆除

Cutting
Pemotong
切割

Grinding / Sanding
Pergilas / Pasak
磨光 / 打磨

Sawing
Guaian
切割

Planing / Routing
Pegulas / Pasak
刨平 / 开槽

Others
Lain-lain
其他

Outdoor Power Equipment
Alatan Kerja Luar
户外动力设备

Makita
MAKITA



Li-ion Ah 6.0 5.0 4.0 3.0 2.0 1.5

DUT130RFE | **DUT130Z** | **DUT131Z**
 RM 2,787 | RM 1,810 | RM 2,548

Cordless Mixer
 Pengadun Tanpa Kord
 充电式搅拌机

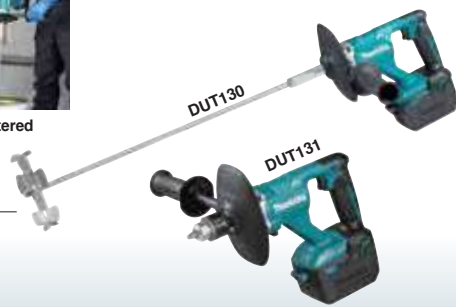

- Battery cover prevents concrete to be scattered on the battery

Standard Equipment:
 DUT130: Mixing Blade, Shaft, Shaft Holder, Side Grip, Front Cover, Wrenches, Tool Bag

DUT131: Front Cover, Side Grip, Chuck Key, Tool Bag

- RFE: 1x Rapid Charger, 2x 3.0Ah Battery
- Z: Without Charger & Battery



Chuck Capacity Kapasiti Chuck 夹头能力	1.5 - 13mm (1/16 - 1/2") DUT131
Blade Diameter Diameter Bilah 锯片直径	165mm (6-1/2") DUT130
Shank size of tool holder portion Batang Saiz 柄部尺寸	M12 or M14 DUT130
No Load Speed (RPM) Kelajuan Tanpa Beban 回转速数	High: 0 - 1,300 Low: 0 - 350
Dimensions (L x W x H) Dimensi 体积	916x89x231mm DUT130 (36"x3-1/2"x9-1/8") 307x89x231mm DUT131 (12-1/8"x3-1/2"x9-1/8")
Net Weight Berat Bersih 淨重	2.5 - 2.8 kg (5.6 - 6.3 lbs.) DUT130 2.7 - 3.0kg (5.8 - 6.6lbs.) DUT131

DCS553Z 150mm (5-7/8")
 RM 2,087

Cordless Metal Cutter
 Pemotong Logam Tanpa Kord
 充电式金属切割机



- Built-in dust collection box for cleaner work environment

Standard Equipment: TCT Saw Blade, Hex Wrench, Safety Goggles, Guide Rule

- Z: Without Charger & Battery



Max Output Keluaran Maksima 最大输出	600W
Blade Diameter Diameter Bilah 锯片直径	150mm (5-7/8")
Hole Diameter Diameter Lubang 孔直径	20mm (13/16")
Max Cutting Capacity Kapasiti Pemotongan Maksimum 最大切割能力	90°: 57.5mm (2-1/4")
No Load Speed (RPM) Kelajuan Tanpa Beban 回转速数	4,200
Dimensions (L x W x H) Dimensi 体积	267x186x250mm (10-1/2"x7-3/8"x9-7/8")
Net Weight Berat Bersih 淨重	2.8 - 3.1kg (6.1 - 6.8lbs.)
Work Amount (approx.) Jumlah Kerja 工作量	125 cuts with BL1850B Saw Blade - Carbon Steel Pipe Ø 34mm, Thickness 3.2mm

DCS552Z 136mm (5-3/8")
 RM 1,290

Cordless Metal Cutter
 Pemotong Logam Tanpa Kord
 充电式金属切割机



- Built-in dust collection box for cleaner work environment

Standard Equipment: TCT Saw Blade (B-07319), Hex Wrench, Safety Goggles

- Z: Without Charger & Battery



Max Output Keluaran Maksima 最大输出	370W
Blade Diameter Diameter Bilah 锯片直径	136mm (5-3/8")
Hole Diameter Diameter Lubang 孔直径	20mm (13/16")
Max Cutting Capacity Kapasiti Pemotongan Maksimum 最大切割能力	90°: 50.5mm (2")
No Load Speed (RPM) Kelajuan Tanpa Beban 回转速数	3,600
Dimensions (L x W x H) Dimensi 体积	348x196x203mm (13-3/4"x7-3/4"x8")
Net Weight Berat Bersih 淨重	2.4 - 2.7kg (5.3 - 6.0lbs.)
Work Amount (approx.) Jumlah Kerja 工作量	125 cuts with BL1850B Saw Blade - Carbon Steel Pipe Ø 34mm, Thickness 3.2mm

DCS551RFJ | **DCS551Z** 150mm (5-7/8")
 RM 2,835 | RM 1,860

Cordless Metal Cutter
 Pemotong Logam Tanpa Kord
 充电式金属切割机



- Cuts 51mm (2") conduit in a single pass

Standard Equipment: TCT Saw Blade (B-46296), Hex Wrench, Safety Goggles

- RFJ: 1x Rapid Charger, 2x 3.0Ah Battery, 1x Makpac Connector Box
- Z: Without Charger, Battery & Carrying Case



Blade Diameter Diameter Bilah 锯片直径	150mm (5-7/8")
Max Cutting Capacity Kapasiti Pemotongan Maksimum 最大切割能力	90°: 57.5mm (2-1/4")
No Load Speed (RPM) Kelajuan Tanpa Beban 回转速数	3,900
Dimensions (L x W x H) Dimensi 体积	332x158x231mm (13-3/4"x6-1/4"x9-1/8")
Net weight Berat Bersih 淨重	2.5 - 2.8kg (5.5 - 6.2lbs)
Work Amount (approx.) Jumlah Kerja 工作量	210 pcs with BL1850B Saw Blade - Wire Tube Ø 38.1mm, Wall Thickness 1.4mm

DCS550RFE | **DCS550Z** 136mm (5-3/8")
 RM 2,140 | RM 1,165

Cordless Metal Cutter
 Pemotong Logam Tanpa Kord
 充电式金属切割机



- Carbide-tipped 30T blade for cutting a wide range of materials

Standard Equipment: TCT Saw Blade (B-07319), Hex Wrench, Safety Goggles

- RFE: 1x Rapid Charger, 2x 3.0Ah Battery
- Z: Without Charger, Battery & Carrying Case



Blade Diameter Diameter Bilah 锯片直径	136mm (5-3/8")
Max Cutting Capacity Kapasiti Pemotongan Maksimum 最大切割能力	90°: 51mm (2")
No Load Speed (RPM) Kelajuan Tanpa Beban 回转速数	3,600
Dimensions (L x W x H) Dimensi 体积	348x180x201mm (13-3/4"x7-1/8"x7-7/8")
Net weight Berat Bersih 淨重	2.2 - 2.6kg (4.9 - 5.7lbs)
Work Amount (approx.) Jumlah Kerja 工作量	216 pcs with BL1850B Saw Blade - Wire Tube Ø 38.1mm, Wall Thickness 1.4mm

* All list price shown are for reference only (exclude SST).

* Semua harga yang ditunjukkan adalah untuk rujukan sahaja (tidak termasuk SST). 所有显示的建议零售价仅供参考 (不包括SST)。

Cordless
 Lampu Sorot LED
 LED NIGHT
 Vacuum Cleaner
 Penyedut Vakuum
 Drilling / Fastening
 Bor / Pasang
 Impact Drilling / Demolition
 Bor / Pemisah
 Cutting / Sanding
 Memotong / Mengkilap
 Grinding / Routing
 Mengkilap / Mengkilap
 Sawing / Grouting
 Mengkilap / Mengkilap
 Planing / Routing
 Mengkilap / Mengkilap
 Others
 Lain-lain
 Outdoor Power Equipment
 Alatan Kuasa Luar



18V

LXT

Li-ion Ah 6.0 5.0 4.0 3.0 2.0 1.5

DJS130RFE | **DJS130Z** 1.3mm 440 mm
 RM 2,783 | RM 1,808

Cordless Metal Shear
 Pemotong Logam Tanpa Kord
 充电式电剪

- 360° swivel shear head for increased cutting convenience

Standard Equipment: Hex Wrench

- RFE: 1x Rapid Charger, 2x 3.0Ah Battery
- Z: Without Charger, Battery & Carrying Case

*Not applicable for Z model

Capacity Kapasiti 能力	Steel up to 400 N/mm ² : 1.3mm Steel up to 600 N/mm ² : 1.0mm 2,800
No Load Speed (RPM) Kelajuan Tanpa Beban 回转数	
Dimensions (L x W x H) Dimensi 体积	350x80x193mm (13-3/4"x3-1/8"x7-5/8")
Net weight Berat Bersih 淨重	2.3 - 2.6kg (5.0 - 5.8lbs)
Work Amount (approx.) Jumlah Kerja 工作量	200 pcs with BL1850B Cutting (SPCC Sheet 1.0 x 600mm)

DJS161Z 1.6mm 430 mm
 RM 1,808

Cordless Straight Shear
 Pemotong Logam Lurus
 Tanpa Kord
 充电式电剪穿式

- High cutting capacity: cuts up to 1.6mm thick mild steel sheet

Standard Equipment: Hex Wrench, Thickness Gauge

- Z: Without Charger & Battery

Capacity Kapasiti 能力	Steel up to 400 N/mm ² : 1.6mm Steel up to 600 N/mm ² : 1.2mm Aluminum up to 200 N/mm ² : 2.5mm
Strokes Per Minute (SPM) Kelajuan Strok 冲程速度	4,300
Dimensions (L x W x H) Dimensi 体积	362x78x118mm (14-1/4"x3-1/16"x4-5/8")
Net weight Berat Bersih 淨重	1.8 - 2.2kg (4.1 - 4.8lbs)
Work Amount (approx.) Jumlah Kerja 工作量	95 pcs with BL1850B Cutting (Thin Metal Plate 1.2mm)

DJS101Z 1.0mm 430 mm
 RM 2,133

Cordless Metal Shear
 Pemotong Logam Tanpa Kord
 充电式电剪

- Easy curve cutting with a smooth edge

Standard Equipment: Hex Wrench

- Z: Without Charger & Battery

Capacity Kapasiti 能力	Steel up to 400 N/mm ² : 1.0mm Steel up to 600 N/mm ² : 0.7mm Aluminum up to 200 N/mm ² : 2.5mm
Strokes Per Minute (SPM) Kelajuan Strok 冲程速度	4,300
Dimensions (L x W x H) Dimensi 体积	364x78x118mm (14-3/8"x3-1/16"x4-5/8")
Net weight Berat Bersih 淨重	1.8 - 2.2kg (4.0 - 4.7lbs)
Work Amount (approx.) Jumlah Kerja 工作量	150 pcs with BL1850B Cutting (Steel sheet SUS430 600x1.0mm)

DJN161Z 1.6mm (16Ga) 430 mm
 RM 2,398

Cordless Nibbler
 Tukul Pemutar Skru Bergerudi
 Tanpa Kord
 充电式电冲剪

- Ideal for cutting roofing sheet metal at thicknesses up to 16 gauge

Standard Equipment: Hex Wrench, Wrench, Punch, Die

- Z: Without Charger & Battery

Capacity Kapasiti 能力	Steel up to 400 N/mm ² : 1.6mm Steel up to 600 N/mm ² : 1.2mm Aluminum up to 200 N/mm ² : 2.5mm
Min. Cutting Radius Radius Pemotongan Minimum 最小切割半径	Inside edge: 45mm (1-3/4") Outside edge: 50mm (2")
Strokes Per Minute (SPM) Kelajuan Strok 冲程速度	1,900
Dimensions (L x W x H) Dimensi 体积	313x78x189mm (12-3/8"x3-1/16"x7-7/16")
Net weight Berat Bersih 淨重	1.9 - 2.3kg (4.3 - 5.0lbs)
Work Amount (approx.) Jumlah Kerja 工作量	30m with BL1850B Cutting (Steel Plate 1mm)

DRV250Z | **DRV150Z**
 RM 8,315 | RM 8,315

Cordless Rivet Gun
 Penembak Rivet Tanpa Kord
 充电式拉钉枪

- Compact center height for increased maneuverability against a wall

Standard Equipment: Grease (191D57-7), Accessory Set, Belt Clip

- Z: Without Charger & Battery



Max Pulling Force Kekuatan Tarikan Maksimum 拉钉力量	20kN DRV250 10kN DRV150
Length of Stroke Panjang Strok 冲程长度	30mm (1-3/16") DRV250 25mm (1") DRV150
Dimensions (L x W x H) Dimensi 体积	320x79x287mm DRV250 (12-5/8"x3-1/8"x11-1/4") 310x80x287mm DRV150 (12-1/4"x3-1/8"x11-1/4")
Net Weight Berat Bersih 淨重	2.1 - 2.4kg (4.6 - 5.2lbs.) DRV250 1.9 - 2.2kg (4.3 - 5.0lbs.) DRV150

* All list price shown are for reference only (exclude SST).

* Semua harga yang ditunjukkan adalah untuk rujukan sahaja (tidak termasuk SST). 所有显示的建议零售价仅供参考 (不包括SST)。

 Cordless
 Tanpa Kabel / 无线

 LED Flashlight
 Lampu Sinar LED
 LED 照明灯

 Vacuum Cleaner
 Penjerap Vakuum
 吸尘器

 Drilling / Fastening
 Gergaji / Pengikat
 钻孔 / 紧固

 Impact Drilling / Demolition
 Gergaji / Penembak
 冲击钻孔 / 拆除

 Cutting
 Pemotong
 切割

 Grinding / Sanding
 Pengisar / Pasir
 打磨 / 磨光

 Sawing
 Gergaji
 锯切

 Planing / Routing
 Penghalus / Tumpang
 刨平 / 开槽

 Others
 Lain-lain
 其他

 Outdoor Power Equipment
 Alatan Kerja Luar
 户外设备

 Makita
 1915

 Makita
 1915

18V

LXT

Li-ion Ah 6.0 5.0 4.0 3.0 2.0 1.5

Cordless Rebar Tying Tool

Alat Pengikat Rebar Tanpa Kord 充电式钢筋捆绑机

Easy to load with tie wire reel



1 Push the release lever
Tekan tuas pelepas 按下釋放桿

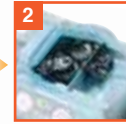

2 Put a reel and pass a wire through the hole
Letakkan keluli wayar melalui lubang 將鋼絲穿過通槽



3 Release the lock lever
Lepaskan tuas kunci 釋放鎖定桿



*Jumlah Kerja 工作量
Work Amount with BL1850B (D10 x D10 Rebar)
5300 times
(approx.)

*Continuous Usage Time/Work Amount: Actual performance may vary based on application. Masa Penggunaan Berterusan/Jumlah Kerja: Prestasi sebenar mungkin berbeza mengikut aplikasi. 连续使用时间/工作量: 实际表现可能因应用情况而异。

Tying Speed
Kelajuan mengikat 捆绑速度
0.95
second with (D10 x D10 Rebar)

1 Reel about **120 times**
(D10 x D10 Rebar)

Accessories
Aksesori 配件

Tie Wire Set (Ø0.8mm) 50pcs/ box
Part No. 199137-9

Applicable Rebars: D10 x D10 - (D13 x 2) x (D13 x 2)

Tying Capacity (2 pcs of rebars)	Tying Capacity (3 pcs of rebars)		Tying Capacity (4 pcs of rebars)	
	D10 (#3)	D13 (#4)	D10 (#3) x D10 (#3)	D13 (#4) x D13 (#4)
D10 (#3)	✓	✓	✓	✓
D13 (#4)	✓	✓	✓	✓
D16 (#5)	✓	✓	✓	—

(# means perimeter length: cm)

DTR180ZJ
RM 5,697

Cordless Rebar Tying Tool
Alat Pengikat Rebar Tanpa Kord
充电式钢筋捆绑机

- Continuous actuation mode for efficient continuous rebar tying

Standard Equipment: Hex Wrench, Hook

• ZJ: With 1x Makpac Connector Box, Without Charger & Battery

Tie Wire Wayar Pengikat 绑线	ø0.8mm
Applicable Rebars Keluli yang Sesuai 适用钢筋	D10 x D10 - (D13 x 2) x (D13 x 2)
Dimensions (L x W x H) Dimensi 体积	304x93x318mm (12"x3-2/3"x12-1/2")
Net Weight Berat Bersih 淨重	2.3 - 2.6kg (5.1 - 5.7lbs.)
Work Amount (approx.) Jumlah Kerja 工作量	5300 times with BL1850B Tying (D10 x D10 Rebar)

Cordless Hole Puncher

Penebuk Lubang Tanpa Kord 充电式油压冲孔机

Motor section swivels full 360° degrees
Bahagian motor boleh berpusing 360° darjah
电机部分可360°度旋转

(Unit: mm)
62.5 8.5
15
40
90
Punch Die

Punching Capacity Kapasiti melubang 冲孔能力

Flat Bar Keluli Rata 扁钢	Max: 80mm x t8 (Center punching)
Angle Keluli Sudut 角钢	Min: 40mm x 40mm x t3 Max: 80mm x 80mm x t8
Channel Keluli berbentuk C 型钢	Min: 75mm x 40mm Max: 100mm x 50mm (Flange punching)

DPP200ZK DPP200Z
Price TBA Price TBA

Cordless Hole Puncher
Penebuk Lubang Tanpa Kord
充电式油压冲孔机

- Punches up to 20 mm Holes through Steel Plate up to 8 mm thick

Standard Equipment: Punch, Dice, Hex Wrench, Spanner, Bar for fastening nuts, Grip, Oil

• ZK: With Carrying Case, Without Charger & Battery
• Z: Without Charger & Battery

NEW BARU 新

Capacity Kapasiti 容量	Steel: 20mm (13/16") Stainless Steel: 20mm (13/16") 40mm (1-9/16")
Max Throat Depth Kedalaman Maksimum 最大深度	40mm (1-9/16")
Dimensions (L x W x H) Dimensi 体积	417x127x315mm (16-3/8"x5"x12-3/8")
Net Weight Berat Bersih 淨重	10.5kg (23.2lbs.)

* All list price shown are for reference only (exclude SST).

* Semua harga yang ditunjukkan adalah untuk rujukan sahaja (tidak termasuk SST). 所有显示的建议零售价仅供参考 (不包括SST)。

Cordless Impact Drill
LED Flashlight
Vacuum Cleaner
Drilling / Fastening
Impact Drilling / Demolition
Cutting
Grinding / Sanding
Sawing
Planing / Routing
Others
Outdoor Power Equipment





Cordless Threaded Rod Cutter

Pemotong Batang Keluli Tanpa Kord 充电式螺纹杆切割机

*Jumlah Kerja 工作量
Work Amount
 with BL1850B
 (Mild steel M10)
1,330 rods
 (approx.)

* Continuous Usage Time/ Work Amount: Actual performance may vary based on application.
 Masa Penggunaan Berterusan/ Jumlah Kerja: Prestasi sebenar mungkin berbeza mengikut aplikasi.
 连续使用时间/ 工作量: 实际表现可能因应用而异。

Cutting Capacity
 Kapasiti 能力
M6 - M10
 (W3/8")



Performs stable cutting even on the floor
 Pemotongan yang stabil walaupun di lantai
 即使在地板上也能进行稳定的切割

LED job light
 Lampu kerja LED
 LED工作灯

Rod Guide There are two rod guide positions
 Terdapat dua kedudukan panduan tuas 有两个杆导向位置

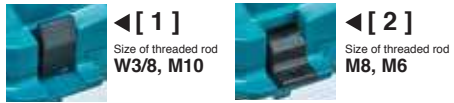

Blade Cover
 Can be used as a rod support
 Penutup pisau Boleh digunakan sebagai penyangga rod
 刀片盖可用作杆支撑

Accessories
 Aksesori 配件

	Cutter Blade Set Cutting capacities: W3/8 (for •Mild steel •Stainless steel) Part No. 199080-2		Cutter Blade Set Cutting capacities: M6 (for •Mild steel •Stainless steel) Part No. 199086-0		Cutter Blade Set Cutting capacities: M8 (for •Mild steel •Stainless steel) Part No. 199084-4		Cutter Blade Set Cutting capacities: M10 (for •Mild steel) Part No. 199082-8
--	--	--	--	--	--	--	--

DSC102ZJ
 RM 5,638

Cordless Threaded Rod Cutter
 Pemotong Batang Keluli Tanpa Kord
 充电式螺纹杆切割机

- More Compact & High Productivity



Standard Equipment: Cutter Blade, Hex Socket Head Bolt, Blade Cover, Depth Gauge, Thumb Screw, Hex Wrench

- ZJ: With 1x Makpac Connector Box, Without Charger & Battery



Capacity Kapasiti 能力	Mild Steel: W3/8, M10, M8, M6 Stainless Steel: W3/8, M8, M6
Min. Cutting Length Panjang Pemotongan Minimum 最小切割长度	20mm (13/16")
Dimensions (L x W x H) Dimensi 体积	199x103x308mm (7-7/8"x4-1/16"x12-1/8")
Net Weight Berat Bersih 净重	2.8 - 3.2kg (6.2 - 7.0lbs.)
Work Amount (approx.) Jumlah Kerja 工作量	1330 rods with BL1850B (Mild steel M10)

DSC121ZK
 RM 19,053

Cordless Threaded Rod Cutter
 Pemotong Batang Berulir Tanpa Kord
 充电式螺纹杆切割机

- Power Cutting at High Speed



Standard Equipment: W3/8 Cutter Blade, Stand, Oil, Hex Wrench

- ZK: With 1x Makpac Connector Box, Without Charger & Battery



Capacity Kapasiti 能力	Steel: 8 - 12mm (5/16" - 1/2")
Cutting Speed (sec) Kelajuan Memotong 刀片速度	3.0
Dimensions (L x W x H) Dimensi 体积	212x323x260mm (8-3/8"x12-3/4"x10-1/4")
Net Weight Berat Bersih 净重	6.0kg (13.2lbs.)
Work Amount (approx.) Jumlah Kerja 工作量	420 rods with BL1850B (Mild steel M12)

DSC162Z DSC163ZK
 RM 20,457 | RM 21,190

Cordless Steel Rod Cutter
 Pemotong Keluli Tanpa Kord
 充电式钢筋切割机

- Spark free cutting of rebar and steel rod ideal for use in sensitive areas



Standard Equipment: Wrench, Hex Wrench, Oil supply

- Z: Without Charger & Battery
- ZK: With 1x Carrying Case, Without Charger & Battery



Cutting Capacity Kapasiti Pemotongan 切割能力	Dia.: 3 - 16mm (1/8" - 5/8")
Cutting Speed (sec) Kelajuan Memotong 切割速度	4.0 DSC162 2.8 DSC163
Dimensions (L x W x H) Dimensi 体积	380x108x265mm DSC162 (15"x4-1/4"x10-3/8") 360x108x276mm DSC163 (14-1/8"x4-1/4"x10-7/8")
Net Weight Berat Bersih 净重	7.1kg (15.7lbs.) DSC162 6.9kg (15.2lbs.) DSC163
Work Amount (approx.) Jumlah Kerja 工作量	191 pcs with BL1850B DSC162 Cutting (Rebar ø16) 233 pcs with BL1850B DSC163 Cutting (Rebar ø16)

* All list price shown are for reference only (exclude SST).

* Semua harga yang ditunjukkan adalah untuk rujukan sahaja (tidak termasuk SST). 所有显示的建议零售价仅供参考 (不包括SST)。

Cordless
Tangan-tangan
LED
LEDMOT
Vacuum Cleaner
Penyedut Debu
BLESS
Drilling / Fastening
Gredil / Pasang
M6, M8, M10
Impact Drilling / Demolition
Dremel / Pasang
M6, M8, M10
Cutting
Pemotong
M6, M8, M10
Grinding / Sanding
Pergasil / Pasang
M6, M8, M10
Sanding
Gergaji
M6, M8, M10
Planing / Routing
Pegilahan / Tangkapan
M6, M8, M10
Others
Lain-lain
M6, M8, M10
Outdoor Power Equipment
Alatan Kerja Luar
M6, M8, M10
Thakita
1987

18V

LXT

Li-ion Ah 6.0 5.0 4.0 3.0 2.0 1.5

DSC191Z

RM 22,118

440

Cordless Steel Rod CutterPemotong Keluli Tanpa Kord
充电式钢筋切割机

- Ideal for cutting steel bars laid in concrete slab

Standard Equipment: Wrench, Hex Wrench, Oil supply

- Z: Without Charger & Battery

**Cutting Capacity**

Kapasiti Pemotongan 切割能力

Dia.: 3 - 20mm (1/8" - 3/4")

Cutting Speed (sec)

Kelajuan Memotong 切割速度

6.5

Dimensions (L x W x H)

Dimensi 体积

412x212x284mm

(16-1/5"x8-3/8"x11-1/8")

Net Weight

Berat Bersih 淨重

11.1 - 11.2kg (24.5 - 24.6lbs)

Work Amount (approx.)

Jumlah Kerja 工作量

333 pcs with BL1850B
Cutting (Rebar ϕ 10)**DSC251ZK**

RM 9,213

Cordless Steel Rod CutterPemotong Keluli Tanpa Kord
充电式钢筋切割机

- Ideal for edge cutting of threaded rods and rebars

Standard Equipment: Tipped Saw, Dust Bag, Side Grip, Hex Wrench

- ZK: Without Charger & Battery



BL MOTOR ADT

Blade Diameter

Diameter Bilah 锯片直径

110mm (4-5/16")

Cutting Capacity

Kapasiti Pemotongan 切割能力

Dia.: 10 - 25mm (3/8" - 1")

No Load Speed (RPM)

Kelajuan Tanpa Beban 回转速数

2,200

Dimensions (L x W x H)

Dimensi 体积

471x137x139mm

(18-1/2"x5-3/8"x5-1/2")

Net Weight

Berat Bersih 淨重

3.9 - 4.0kg (8.7 - 8.8lbs)

Work Amount (approx.)

Jumlah Kerja 工作量

60 pcs with BL1850B
Cutting Rebar SD345 490N/mm² D25**DPB182Z**

RM 1,657

Cordless Portable Band SawGergaji Pita Tanpa Kord
充电式轻便带锯

- Aluminum housing improves rigidity and prevents blade coming off

Standard Equipment: Band Saw Blade, Hex Wrench

- Z: Without Charger & Battery



VIDEO CLIP

DPB182

Models and specs may vary by country.

Capacity

Kapasiti 能力

Round: 64mm (2-1/2")

Rectangular: 64x64mm (2-1/2"x2-1/2")

Blade Speed

Kelajuan Bilah 刀片速度

3.2m/s (630ft/min.)

Blade Size

Saiz Bilah 锯片尺寸

Length: 835mm (32-7/8")

Width: 13mm (1/2")

Thickness: 0.5mm (0.02")

Dimensions (L x W x H)

Dimensi 体积

477x197x229mm

(18-3/4"x7-3/4"x9")

Net Weight

Berat Bersih 淨重

3.8 - 4.1kg (8.3 - 9.0lbs.)

DPB180Z

RM 2,717

430

Cordless Portable Band SawGergaji Pita Tanpa Kord
充电式轻便带锯

- 6-Setting variable speed control dial enables user to match the speed to the application

Standard Equipment: Band Saw Blade, Hex Wrench

- Z: Without Charger & Battery

**Capacity**

Kapasiti 能力

Round: 120mm (4-3/4")

Rectangular workpiece w/o stand:

120x120mm (4-3/4"x4-3/4")

Blade Speed

Kelajuan Bilah 刀片速度

1.4-2.7m/s (275-530ft/min.)

Dimensions (L x W x H)

Dimensi 体积

523x231x313mm

(20-5/8"x9-1/8"x12-3/8")

Net Weight

Berat Bersih 淨重

6.8 - 7.1kg (14.9 - 15.7lbs)

Work Amount (approx.)

Jumlah Kerja 工作量

200 pcs with BL1850B
Cutting (Steel Wire Tube ϕ 38.1mm)
(1.4mm Thickness)

* All list price shown are for reference only (exclude SST).

* Semua harga yang ditunjukkan adalah untuk rujukan sahaja (tidak termasuk SST). 所有显示的建议零售价仅供参考 (不包括SST)。

Cordless
Tampal Kord Tanpa KordLED Flashlight
Lampu Suluh LED
LED 3x3x3Vacuum Cleaner
Penyedut Vakuum
吸尘器Drilling / Fastening
Draib / Pengetat
电钻 / 螺丝Impact Drilling / Demolition
Draib / Penyah
电钻 / 电锤Cutting
PemotongGrinding / Sanding
Pengisar / Hais
磨刀 / 砂纸Sawing
GergajiPlaning / Routing
Pengayun / Tengam
刨 / 铣Others
Lain-lain
其他Outdoor Power Equipment
Alatan Kerja Luar
户外动力设备Makita
MAKITA

18V LXT Li-ion Ah 6.0 5.0 4.0 3.0 2.0 1.5

AWS

Auto - start Wireless System

Switch on the tool, and Vacuum cleaner is activated

Sistem permulaan wayarles automatik 无线自动启动系统

It has been impossible, but now Vacuum cleaner can be automatically activated by Cordless tools with our newly developed wireless system

hidupkan alat dan pembersih vakum akan diaktifkan pembersih vakum boleh diaktifkan secara automatik oleh alat tanpa kord dengan Sistem permulaan wayarles automatik baru

启动工具，吸尘器自动开启我们新研发的无线系统可以通过无线工具自动激活吸尘器



Bluetooth AWS connects to power tool with Bluetooth

AWS menyambungkan alat melalui Bluetooth AWS通过蓝牙连接电动工具

The Bluetooth® word mark and logos are registered trademarks owned by the Bluetooth SIG, Inc. and any use of such marks by Makita is under license. Other trademarks and trade names are those of their respective owners.

ADT

Automatic Torque Drive Technology
Teknologi Tork Automatik
自动扭力驱动科技

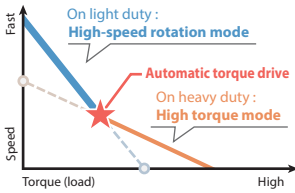

Automatically changes the cutting speed according to load conditions for an optimum operation

Fungsi pertukaran kelajuan automatik 自动变速功能

AFT

Active Feedback Sensing Technology
Teknologi Sensor Maklum Balas Automatik
自动回馈感应科技

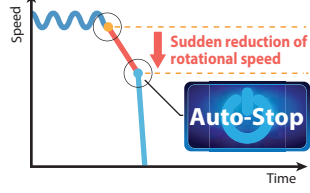

Shuts down the tool to protect the user, if the rotation speed suddenly slows down

Jika kelajuan putaran tiba-tiba dikurangkan, alat akan dimatikan secara automatik untuk melindungi pengguna

若旋转速度突然降低，工具将自动关闭以保护保护使用者

XLOCK

Kunci Mata Pengisar X
砂轮X锁



DGA419, DGA519 only

Just one click to attach the accessories and easy removal just simply pull the lever

Hanya dengan satu klik untuk memasang aksesori dan mudah dilepas hanya tarik tuas

只需单击一下即可安装配件，只需按下红杆即可轻松拆卸

BL MOTOR

Motor tanpa berus
无碳刷马达

Faster Cutting with High power and High torque brushless motor

Pemotongan yang lebih cepat dengan motor tanpa berus berkuasa tinggi

无碳刷马达使切割更快



Electric brake is activated after the tool is switched off

Electric Brake System
Sistem Brek Elektrik
电子自动刹车系统

Brek elektrik diaktifkan selepas alat dimatikan

电子自动刹车在工具关闭后被启动

Model No. 型号			No Load Speed (rpm) 空载转速	Switch Suis 开关	BL MOTOR	AFT	ADT	(BRAKE)	AWS	Anti-restart function 防重启功能	XLOCK
100mm	115mm	125mm									
DGA414	-	DGA514	3,000 - 8,500	Slide	●	●	●	●	●	●	
DGA411	-	DGA511	3,000 - 8,500	Slide	●	●	●	●	●	●	
DGA406	DGA456	-	8,500	Slide	●	●	●	●	●	●	
DGA404	-	-	8,500	Slide	●	●	●	●	●	●	
DGA402	DGA452	-	11,000	Slide	●	●	●	●	●	●	
DGA419	-	DGA519	3,000 - 8,500	Paddle	●	●	●	●	●	●	●
DGA418	-	DGA518	3,000 - 8,500	Paddle	●	●	●	●	●	●	
DGA405	-	DGA505	8,500	Paddle	●	●	●	●	●	●	
DGA408	DGA458	DGA508	8,500	Paddle	●	●	●	●	●	●	

DGA419Z 100mm (4")
RM 1,707

Cordless Angle Grinder
Pengisar Sudut Tanpa Kord
充电式角向磨光机

Paddle Switch
Suis Pemacu 扳机开关



• X-LOCK for toolless accessory changes

Standard Equipment: Grinding Wheel (E-00496), Wheel Cover, Side Grip

• Z: Without Charger, Battery & Carrying Case

BL MOTOR XPT ADT AFT (BRAKE) XLOCK

Wheel Diameter 100mm (4")
Diameter Roda 砂轮直径

Hole Diameter 22.23mm (7/8")
Diameter Lubang 孔径

Max Wheel Thickness 6mm (1/4")
Ketebalan Roda Maksimum 最大砂轮厚度

No Load Speed (RPM) 3,000 - 8,500
Kelajuan Tanpa Beban 回转数

Dimensions (L x W x H) 396x117x147mm
(15-1/2"x4-5/8"x5-3/4")
Dimensi 体积

Net Weight 2.4 - 3.0kg (5.3 - 6.6lbs.)
Berat Bersih 净重

* All list price shown are for reference only (exclude SST).

* Semua harga yang ditunjukkan adalah untuk rujukan sahaja (tidak termasuk SST). 所有显示的建议零售价仅供参考 (不包括SST)。

Cordless
Targeted System

LED Flashlight
Lampu Suis LED
LED照明灯

Vacuum Cleaner
Pembersih Vakum
吸尘器

Drilling / Fastening
Gruat / Pengat
钻孔 / 紧固

Impact Drilling / Demolition
Gruat Impak / Hancurkan
冲击钻孔 / 拆除

Cutting
Pemotong
切割

Grinding / Sanding
Pengisar / Hancur
磨光 / 打磨

Sawing
Gergaji
锯切

Planing / Routing
Penghalus / Tonggah
刨平 / 开槽

Others
Lain-lain
其他

Outdoor Power Equipment
Alatan Kuat Ukir
户外动力设备

Makita
19152



Li-ion Ah 6.0 | 5.0 | 4.0 | 3.0 | 2.0 | 1.5

Cordless
Tampal Kord Tanpa Kord

LED Flashlight
Lampu Suluh LED
LED 180000

Vacuum Cleaner
Penyedut Vakum
BLUCC

Drilling / Fastening
Gali / Pasang
BLU / BLUCC

Impact Drilling / Demolition
Gali / Hancurkan
BLU / BLUCC

Cutting
Memotong
BLU

Grinding / Sanding
Pengisar / Halus
BLU / BLUCC

Sawing
Gergaji
BLU

Planing / Routing
Pegiatan / Tongkat
BLU / BLUCC

Others
Lain-lain
BLU

Outdoor Power Equipment
Alatan Kuasa Luar
BLU / BLUCC

Makita
18V LXT

DGA411Z 100mm (4")
RM 1,103

Cordless Angle Grinder
Pengisar Sudut Tanpa Kord
充电式角向磨光机



Top Slide Switch
Suis Gelangsar Atas 顶部滑动开关
Convenient for left & right handed
Mudah diguna dengan tangan kiri atau kanan 方便左右手



- Spiral bevel gear for more efficient transfer of energy

Standard Equipment: Grinding Wheel (A-80852), Wheel Cover, Side Grip, Lock Nut Wrench

- Z: Without Charger & Battery



Wheel Diameter Diameter Roda 轮片直径	100mm (4")
No Load Speed (RPM) Kelajuan Tanpa Beban 回转速数	3,000 - 8,500
Dimensions (L x W x H) Dimensi 体积	BL1850B: 382x117x140mm (15"x4-5/8"x5-1/2")
Net Weight Berat Bersih 淨重	2.2 - 2.8kg (4.8 - 6.1lbs.)
Continuous Usage Time (approx.) Masa Penggunaan Berterusan 连续使用时间	8 min with BL1850B Metal Sanding Pressing Load of 30N, 3000rpm

DGA414Z 100mm (4")
RM 1,637

Cordless Angle Grinder
Pengisar Sudut Tanpa Kord
充电式角向磨光机



Top Slide Switch
Suis Gelangsar Atas 顶部滑动开关
Convenient for left & right handed
Mudah diguna dengan tangan kiri atau kanan 方便左右手



- Auto-start Wireless System (AWS) connects to compatible vacuum cleaners with Bluetooth

Standard Equipment: Grinding Wheel (A-80852), Wheel Cover, Side Grip, Lock Nut Wrench

- Z: Without Charger & Battery



Wheel Diameter Diameter Roda 轮片直径	100mm (4")
No Load Speed (RPM) Kelajuan Tanpa Beban 回转速数	3,000 - 8,500
Dimensions (L x W x H) Dimensi 体积	BL1850B: 382x117x147mm (15"x4-5/8"x5-3/4")
Net Weight Berat Bersih 淨重	2.2 - 2.8kg (4.9 - 6.3lbs.)
Continuous Usage Time (approx.) Masa Penggunaan Berterusan 连续使用时间	8 min with BL1850B Metal Sanding Pressing Load of 30N, 3000rpm

DGA418Z 100mm (4")
RM 1,707

Cordless Angle Grinder
Pengisar Sudut Tanpa Kord
充电式角向磨光机



Paddle Switch
Suis Pemacu 扳机开关



- Auto-start Wireless System (AWS) connects to compatible vacuum cleaners with Bluetooth

Standard Equipment: Grinding Wheel (A-80852), Wheel Cover, Side Grip, Lock Nut Wrench

- Z: Without Charger & Battery



Wheel Diameter Diameter Roda 轮片直径	100mm (4")
No Load Speed (RPM) Kelajuan Tanpa Beban 回转速数	3,000 - 8,500
Dimensions (L x W x H) Dimensi 体积	BL1850B: 382x117x146mm (15"x4-5/8"x5-3/4")
Net Weight Berat Bersih 淨重	2.2 - 2.9kg (5.0 - 6.3lbs.)
Continuous Usage Time (approx.) Masa Penggunaan Berterusan 连续使用时间	8 min with BL1850B Metal Sanding Pressing Load of 30N, 3000rpm

DGA406RME | **DGA406RFE** | **DGA406Z** 100mm (4")
RM 2,173 | RM 2,008 | RM 1,033

Cordless Angle Grinder
Pengisar Sudut Tanpa Kord
充电式角向磨光机



Top Slide Switch
Suis Gelangsar Atas 顶部滑动开关
Convenient for left & right handed
Mudah diguna dengan tangan kiri atau kanan 方便左右手



- Electric brake for increased operator safety

Standard Equipment: Grinding Wheel (A-80852), Wheel Cover, Side Grip, Lock Nut Wrench

- RME: 1x Rapid Charger, 2x 4.0Ah Battery
- RFE: 1x Rapid Charger, 2x 3.0Ah Battery
- Z: Without Charger, Battery & Carrying Case



Wheel Diameter Diameter Roda 轮片直径	100mm (4")
No Load Speed (RPM) Kelajuan Tanpa Beban 回转速数	8,500
Dimensions (L x W x H) Dimensi 体积	362x117x146mm (14-1/4"x4-5/8"x5-3/4")
Net Weight Berat Bersih 淨重	2.18 - 2.77kg (4.81 - 6.12lbs)
Work Amount (approx.) Jumlah Kerja 工作量	12 m with BL1850B Cutting Concrete Depth 10mm

DGA408RME | **DGA408RFE** | **DGA408Z** 100mm (4")
RM 2,242 | RM 2,078 | RM 1,103

Cordless Angle Grinder
Pengisar Sudut Tanpa Kord
充电式角向磨光机



Paddle Switch
Suis Pemacu 扳机开关



- Efficiency for heavy-duty grinding applications

Standard Equipment: Grinding Wheel (A-80852), Wheel Cover, Side Grip, Lock Nut Wrench

- RME: 1x Rapid Charger, 2x 4.0Ah Battery
- RFE: 1x Rapid Charger, 2x 3.0Ah Battery
- Z: Without Charger, Battery & Carrying Case



Wheel Diameter Diameter Roda 轮片直径	100mm (4")
No Load Speed (RPM) Kelajuan Tanpa Beban 回转速数	8,500
Dimensions (L x W x H) Dimensi 体积	362x117x146mm (14-1/4"x4-5/8"x5-3/4")
Net Weight Berat Bersih 淨重	2.18 - 2.80kg (4.81 - 6.17lbs)
Work Amount (approx.) Jumlah Kerja 工作量	12 m with BL1850B Cutting Concrete Depth 10mm

* All list price shown are for reference only (exclude SST).

* Semua harga yang ditunjukkan adalah untuk rujukan sahaja (tidak termasuk SST). 所有显示的建议零售价仅供参考 (不包括SST)。



Li-ion Ah 6.0 | 5.0 | 4.0 | 3.0 | 2.0 | 1.5

DGA404RTE | **DGA404RFE** | **DGA404Z** 100mm (4")
 RM 2,248 | RM 1,938 | RM 963

Cordless Angle Grinder
 Pengisar Sudut Tanpa Kord
 充电式角向磨光机



Top Slide Switch
 Suis Gelangsar Atas 顶部滑动开关
Convenient for left & right handed
 Mudah diguna dengan tangan kiri atau kanan 方便左右手



- Efficient internal cooling for optimum performance

Standard Equipment: Grinding Wheel (A-80852), Wheel Cover, Side Grip, Lock Nut Wrench

- RTE: 1x Rapid Charger, 2x 5.0Ah Battery
- RFE: 1x Rapid Charger, 2x 3.0Ah Battery
- Z: Without Charger, Battery & Carrying Case



Wheel Diameter Diameter Roda 轮片直径	100mm (4")
No Load Speed (RPM) Kelajuan Tanpa Beban 回转速	8,500
Dimensions (L x W x H) Dimensi 体积	362x117x140mm (14-1/4"x4-5/8"x5-1/2")
Net Weight Berat Bersih 净重	2.10 - 2.71kg (4.63 - 5.98lbs)
Work Amount (approx.) Jumlah Kerja 工作量	12 m with BL1850B Cutting Concrete Depth 10mm



DGA405RFE | **DGA405Z** 100mm (4")
 RM 1,973 | RM 998

Cordless Angle Grinder
 Pengisar Sudut Tanpa Kord
 充电式角向磨光机



Paddle Switch
 Suis Pemacu 扳机开关



- Efficient internal cooling for optimum performance

Standard Equipment: Grinding Wheel (A-80852), Wheel Cover, Side Handle, Lock Nut Wrench

- RFE: 1x Rapid Charger, 2x 3.0Ah Battery
- Z: Without Charger, Battery & Carrying Case



Wheel Diameter Diameter Roda 轮片直径	100mm (4")
No Load Speed (RPM) Kelajuan Tanpa Beban 回转速	8,500
Dimensions (L x W x H) Dimensi 体积	362x117x140mm (14-1/4"x4-5/8"x5-1/2")
Net Weight Berat Bersih 净重	2.08 - 2.69kg (4.59 - 5.94lbs)
Work Amount (approx.) Jumlah Kerja 工作量	12 m with BL1850B Cutting Concrete Depth 10mm

DGA402RFE | **DGA402Z** 100mm (4")
 RM 1,532 | RM 557

Cordless Angle Grinder
 Pengisar Sudut Tanpa Kord
 充电式角向磨光机



Top Slide Switch
 Suis Gelangsar Atas 顶部滑动开关
Convenient for left & right handed
 Mudah diguna dengan tangan kiri atau kanan 方便左右手



- Spiral bevel gear for more efficient transfer of energy

Standard Equipment: Grinding Wheel (A-80852), Wheel Cover, Side Grip, Lock Nut Wrench

- RFE: 1x Rapid Charger, 2x 3.0Ah Battery
- Z: Without Charger, Battery & Carrying Case



Wheel Diameter Diameter Roda 轮片直径	100mm (4")
No Load Speed (RPM) Kelajuan Tanpa Beban 回转速	11,000
Dimensions (L x W x H) Dimensi 体积	317x118x118mm (12-1/2"x4-5/8"x4-5/8")
Net Weight Berat Bersih 净重	1.90 - 2.51kg (4.19 - 5.5 lbs)
Work Amount (approx.) Jumlah Kerja 工作量	13.5 m with BL1850B Cutting Concrete Depth 5mm

DGA456RFE | **DGA456Z** 115mm (4-1/2")
 RM 2,028 | RM 1,053

Cordless Angle Grinder
 Pengisar Sudut Tanpa Kord
 充电式角向磨光机



Top Slide Switch
 Suis Gelangsar Atas 顶部滑动开关
Convenient for left & right handed
 Mudah diguna dengan tangan kiri atau kanan 方便左右手



- Efficiency for heavy-duty grinding applications

Standard Equipment: Grinding Wheel (A-80640), Wheel Cover, Side Handle, Lock Nut Wrench

- RFE: 1x Rapid Charger, 2x 3.0Ah Battery
- Z: Without Charger, Battery & Carrying Case



Wheel Diameter Diameter Roda 轮片直径	115mm (4-1/2")
No Load Speed (RPM) Kelajuan Tanpa Beban 回转速	8,500
Dimensions (L x W x H) Dimensi 体积	362x130x151mm (14-1/4"x5-1/8"x5-15/16")
Net Weight Berat Bersih 净重	2.34 - 3.03kg (5.17 - 6.67lbs)
Work Amount (approx.) Jumlah Kerja 工作量	12 m with BL1850B Cutting Concrete Depth 10mm

DGA458RFE | **DGA458Z** 115mm (4-1/2")
 RM 2,098 | RM 1,123

Cordless Angle Grinder
 Pengisar Sudut Tanpa Kord
 充电式角向磨光机



Paddle Switch
 Suis Pemacu 扳机开关



- Electric brake for increased operator safety

Standard Equipment: Grinding Wheel (A-80640), Wheel Cover, Side Handle, Lock Nut Wrench

- RFE: 1x Rapid Charger, 2x 3.0Ah Battery
- Z: Without Charger, Battery & Carrying Case



Wheel Diameter Diameter Roda 轮片直径	115mm (4-1/2")
No Load Speed (RPM) Kelajuan Tanpa Beban 回转速	8,500
Dimensions (L x W x H) Dimensi 体积	362x130x151mm (14-1/4"x5-1/8"x5-15/16")
Net Weight Berat Bersih 净重	2.34 - 3.03kg (5.17 - 6.67lbs)
Work Amount (approx.) Jumlah Kerja 工作量	12 m with BL1850B Cutting Concrete Depth 10mm

* All list price shown are for reference only (exclude SST).

* Semua harga yang ditunjukkan adalah untuk rujukan sahaja (tidak termasuk SST). 所有显示的建议零售价仅供参考 (不包括SST)。

Cordless
Tangkas Tanpa Kord

LED Flashlight
Lampu Senter LED
LECOBRIGHT

Vacuum Cleaner
Penyedut Vakuum
VACUUM

Drilling / Fastening
Gergaji / Pasak
METSU / 美达士

Impact Drilling / Demolition
Gergaji / Pasak
METSU / 美达士

Cutting
Pemotong
SUN

Grinding / Sanding
Pengisar / Pasak
METSU / 美达士

Sawing
Gergaji
METSU / 美达士

Planing / Routing
Pengisar / Pasak
METSU / 美达士

Others
Lain-lain
METSU / 美达士

Outdoor Power Equipment
Alatan Kerja Luar
METSU / 美达士

Thakita
METSU

18V

LXT

Li-ion Ah 6.0 5.0 4.0 3.0 2.0 1.5

DGA452RME RM 1,722 | **DGA452RFE** RM 1,557 | **DGA452Z** RM 582 | 115mm (4-1/2") | 430 RPM

Cordless Angle Grinder
Pengisar Sudut Tanpa Kord
充电式角向磨光机



Top Slide Switch

Suis Gelangkas Atas 顶部滑动开关
Convenient for left & right handed
Mudah diguna dengan tangan kiri atau kanan 方便左右手



- Compact barrel grip for easy handling

Standard Equipment: Grinding Wheel (A-80640), Wheel Cover, Side Handle, Lock Nut Wrench

- RME: 1x Rapid Charger, 2x 4.0Ah Battery
- RFE: 1x Rapid Charger, 2x 3.0Ah Battery
- Z: Without Charger, Battery & Carrying Case

*Not applicable for Z model

Wheel Diameter Diameter Roda 轮片直径	115mm (4-1/2")
No Load Speed (RPM) Kelajuan Tanpa Beban 回转数	11,000
Dimensions (L x W x H) Dimensi 体积	317x129x126mm (12-1/2"x5-1/8"x5")
Net Weight Berat Bersih 淨重	2.06 - 2.71kg (4.53 - 5.97lbs)
Work Amount (approx.) Jumlah Kerja 工作量	25 m with BL1850B Cutting Concrete Depth 5mm

Cordless Angle Grinder

Pengisar Sudut Tanpa Kord
充电式角向磨光机

XLOCK

JUST ONE CLICK TO ATTACH THE ACCESSORIES AND EASY REMOVAL
JUST SIMPLY PULL THE LEVER

Hanya dengan satu klik untuk memasang aksesori dan mudah dilepas hanya tarik tuas
只需单击一下即可安装配件，只需按下红杆即可轻松拆卸

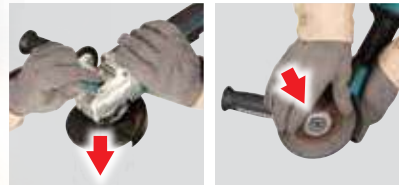

INSTALLATION



REMOVAL

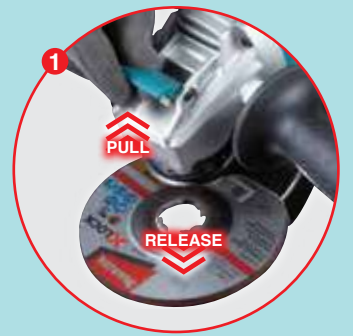

Variable speed control dial
Dial kawalan kelajuan ubah 变速控制拨盘

Wheel release lever
Pelepas roda 轮片释放杆

Paddle Switch
Suis Pemacu 扳机开关

DGA519Z 125mm (5") | RM 1,747

Cordless Angle Grinder
Pengisar Sudut Tanpa Kord
充电式角向磨光机



Paddle Switch

Suis Pemacu 扳机开关



- X-LOCK for toolless accessory changes

Standard Equipment: Grinding Wheel (E-00402), Wheel Cover, Side Grip

- Z: Without Charger, Battery & Carrying Case

*Not applicable for Z model

Wheel Diameter Diameter Roda 轮片直径	125mm (5")
Hole Diameter Diameter Lubang 孔直径	22.23mm (7/8")
Max Wheel Thickness Ketebalan Roda Maksimum 最大轮片厚度	6mm (1/4")
No Load Speed (RPM) Kelajuan Tanpa Beban 回转数	3,000 - 8,500
Dimensions (L x W x H) Dimensi 体积	396x140x147mm (15-1/2"x5-1/2"x5-3/4")
Net Weight Berat Bersih 淨重	2.5 - 3.1kg (5.5 - 6.8lbs.)

* All list price shown are for reference only (exclude SST).

* Semua harga yang ditunjukkan adalah untuk rujukan sahaja (tidak termasuk SST). 所有显示的建议零售价仅供参考 (不包括SST)。

Cordless Impact Driver
LED Flashlight
Vacuum Cleaner
Drilling / Fastening
Impact Drilling / Demolition
Cutting
Grinding / Sanding
Sawing
Planing / Routing
Others
Outdoor Power Equipment





Li-ion Ah 6.0 5.0 4.0 3.0 2.0 1.5

DGA511Z 125mm (5")
RM 1,140

Cordless Angle Grinder
Pengisar Sudut Tanpa Kord
充电式角向磨光机



Top Slide Switch

Suis Gelangsar Atas 顶部滑动开关
Convenient for left & right handed
Mudah diguna dengan tangan kiri atau kanan 方便左右手



- Spiral bevel gear for more efficient transfer of energy

Standard Equipment: Grinding Wheel (A-80656), Wheel Cover, Side Grip, Lock Nut Wrench
• Z: Without Charger & Battery



Wheel Diameter Diameter Roda 轮片直径	125mm (5")
No Load Speed (RPM) Kelajuan Tanpa Beban 回转数	3,000 - 8,500
Dimensions (L x W x H) Dimensi 体积	BL1850B: 382x140x145mm (15"x5-1/2"x5-3/4")
Net Weight Berat Bersih 净重	2.3 - 3.0kg (5.1 - 6.6lbs.)
Work Amount (approx.) Jumlah Kerja 工作量	13.8 m with BL1850B Cutting Concrete Depth 10mm

DGA514Z 125mm (5")
RM 1,675

Cordless Angle Grinder
Pengisar Sudut Tanpa Kord
充电式角向磨光机

Top Slide Switch

Suis Gelangsar Atas 顶部滑动开关
Convenient for left & right handed
Mudah diguna dengan tangan kiri atau kanan 方便左右手



- Auto-start Wireless System (AWS) connects to compatible vacuum cleaners with Bluetooth

Standard Equipment: Grinding Wheel (A-80656), Wheel Cover, Side Grip, Lock Nut Wrench
• Z: Without Charger & Battery



Wheel Diameter Diameter Roda 轮片直径	125mm (5")
No Load Speed (RPM) Kelajuan Tanpa Beban 回转数	3,000 - 8,500
Dimensions (L x W x H) Dimensi 体积	BL1850B: 382x140x151mm (15"x5-1/2"x5-15/16")
Net Weight Berat Bersih 净重	2.4 - 3.0kg (5.2 - 6.7lbs.)
Work Amount (approx.) Jumlah Kerja 工作量	13.8 m with BL1850B Cutting Concrete Depth 10mm

DGA518Z 125mm (5")
RM 1,747

Cordless Angle Grinder
Pengisar Sudut Tanpa Kord
充电式角向磨光机

Paddle Switch

Suis Pemacu 扳机开关



- Auto-start Wireless System (AWS) connects to compatible vacuum cleaners with Bluetooth

Standard Equipment: Grinding Wheel (A-80656), Wheel Cover, Side Grip, Lock Nut Wrench
• Z: Without Charger & Battery



Wheel Diameter Diameter Roda 轮片直径	125mm (5")
No Load Speed (RPM) Kelajuan Tanpa Beban 回转数	3,000 - 8,500
Dimensions (L x W x H) Dimensi 体积	BL1850B: 382x140x151mm (15"x5-1/2"x6")
Net Weight Berat Bersih 净重	2.4 - 3.1kg (5.3 - 6.8lbs.)
Work Amount (approx.) Jumlah Kerja 工作量	13.8 m with BL1850B Cutting Concrete Depth 10mm

DGA508RFE | **DGA508Z** 125mm (5")
RM 2,113 | RM 1,138

Cordless Angle Grinder
Pengisar Sudut Tanpa Kord
充电式角向磨光机

Paddle Switch

Suis Pemacu 扳机开关



- Electric brake for increased operator safety

Standard Equipment: Grinding Wheel (A-80656), Wheel Cover, Side Handle, Lock Nut Wrench
• RFE: 1x Rapid Charger, 2x 3.0Ah Battery
• Z: Without Charger, Battery & Carrying Case



Wheel Diameter Diameter Roda 轮片直径	125mm (5")
No Load Speed (RPM) Kelajuan Tanpa Beban 回转数	8,500
Dimensions (L x W x H) Dimensi 体积	362x140x151mm (14-1/4"x5-1/2"x5-15/16")
Net weight Berat Bersih 净重	2.35 - 3.83kg (5.18 - 8.45lbs)
Work Amount (approx.) Jumlah Kerja 工作量	13.8 m with BL1850B Cutting Concrete Depth 10mm

DGA505RFE | **DGA505Z** 125mm (5")
RM 2,008 | RM 1,033

Cordless Angle Grinder
Pengisar Sudut Tanpa Kord
充电式角向磨光机

Paddle Switch

Suis Pemacu 扳机开关



- Efficient internal cooling for optimum performance

Standard Equipment: Grinding Wheel (A-80656), Wheel Cover, Side Handle, Lock Nut Wrench
• RFE: 1x Rapid Charger, 2x 3.0Ah Battery
• Z: Without Charger, Battery & Carrying Case



Wheel Diameter Diameter Roda 轮片直径	125mm (5")
No Load Speed (RPM) Kelajuan Tanpa Beban 回转数	8,500
Dimensions (L x W x H) Dimensi 体积	362x140x145mm (14-1/4"x5-1/2"x5-3/4")
Net weight Berat Bersih 净重	2.26 - 3.73kg (4.98 - 8.23lbs)
Work Amount (approx.) Jumlah Kerja 工作量	13.8 m with BL1850B Cutting Concrete Depth 10mm

* All list price shown are for reference only (exclude SST).

* Semua harga yang ditunjukkan adalah untuk rujukan sahaja (tidak termasuk SST). 所有显示的建议零售价仅供参考 (不包括SST)。

Cordless
Tangan Kordless

LED Flashlight
Lampu Sinar LED
LEDMALAM

Vacuum Cleaner
Penyedut Vakuum
吸尘器

Drilling / Fastening
Guaht / Pasak
电钻 / 螺絲

Impact Drilling / Demolition
Guaht / Pasak
电钻 / 螺絲

Cutting
Pemotong
切割机

Grinding / Sanding
Pengisar / Pasak
磨光机 / 磨光

Sawing
Guaht
锯切

Planing / Routing
Pengisar / Pasak
磨光机 / 螺絲

Others
Lain-lain
其他

Outdoor Power Equipment
Alatan Kerja Luar
户外设备

Thakita
INT

18V

LXT

Li-ion Ah 6.0 5.0 4.0 3.0 2.0 1.5

Cordless Random Orbit Polisher

Pelicin Orbit Tanpa Kord 充电式砂光机

*Masa Penggunaan Berterusan
连续使用时间

Continuous Usage Time
with BL1850B
(Finishing Mode)

30min
(approx.)

*Continuous Usage Time/ Work Amount:
Actual performance may vary based on application.
Masa Penggunaan Berterusan/ Jumlah Kerja: Prestasi sebenar
mungkin berbeza mengikut aplikasi.
连续使用时间/ 工作量: 实际性能可能因应用而异。

High Power for Professional

Kuasa Tinggi untuk Profesional 高功率专业用途



ROUGH POLISHING

Penggilapan kasar 强制旋转模式

Forcible rotation mode

Orbital action with forced rotation of the pad for rough polishing such as scratch removal.



FINE POLISHING

Penggilapan halus 自由旋转模式

Free rotation mode

Orbital action with free rotation of the pad for fine polishing.

DPO600Z | DPO500Z

RM 2,528

RM 2,515

Cordless Random Orbit Polisher
Pelicin Orbit Tanpa Kord
充电式砂光机



- Selectable two rotation mode: normal mode & finishing mode



Standard Equipment: Hex Wrench

- Z: Without Charger & Battery



Pad Size

Saiz Pad 垫大小

Orbits Per Minute (OPM)

Bilangan Putaran 轨道转数

Strokes Per Minute (SPM)

Kelajuan Strok 冲程速度

No Load Speed (RPM)

Kelajuan Tanpa Beban 回转数

Orbit Diameter

Kelajuan Tanpa Beban 回转数

Dimensions (L x W x H)

Dimensi 体积

Net Weight

Berat Bersih 淨重

150mm (6") **DPO600**

125mm (5") **DPO500**

Normal mode: 0 - 6,800

Finishing mode: 0 - 5,200

Normal mode: 0 - 13,600

Finishing mode: 0 - 10,400

Normal mode: 0 - 780

Finishing mode: 0 - 600

5.5mm (7/32")

530x148x126mm **DPO600**

(20-7/8"x5-7/8"x5")

530x123x134mm **DPO500**

(20-7/8"x4-7/8"x5-1/4")

3.1 - 3.6kg (6.8 - 7.9lbs.)

DGD800Z

RM 608

430

Cordless Die Grinder
Pengisar Tanpa Kord
充电式刻磨机

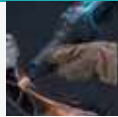

- Slide switch with lock-on for operator convenience



Standard Equipment: Wrench x2

- Z: Without Charger & Battery

DGD801Z

RM 608

430

Cordless Die Grinder
Pengisar Tanpa Kord
充电式刻磨机



- Round collet nut reduces the risk of damages



Standard Equipment: Wrench x2

- Z: Without Charger & Battery

Capacity

Kapasiti 能力

Wheel Diameter

Diameter Roda 轮片直径

No Load Speed (RPM)

Kelajuan Tanpa Beban 回转数

Dimensions (L x W x H)

Dimensi 体积

Net Weight

Berat Bersih 淨重

Work Amount (approx.)

Jumlah Kerja 工作量

Collet : 3mm - 8mm

38mm (1-1/2")

26,000

402x82x118mm

(15-3/4"x3-1/4"x4-5/8")

1.7 - 2.2kg (3.8 - 4.9lbs)

9.0 g with BL1850B

Grinding Steel Plate SS400

Capacity

Kapasiti 能力

Wheel Diameter

Diameter Roda 轮片直径

No Load Speed (RPM)

Kelajuan Tanpa Beban 回转数

Dimensions (L x W x H)

Dimensi 体积

Net Weight

Berat Bersih 淨重

Work Amount (approx.)

Jumlah Kerja 工作量

Collet : 3mm - 8mm

38mm (1-1/2")

25,000

307x82x118mm

(12-1/8"x3-1/4"x4-5/8")

1.5 - 2.0kg (3.3 - 4.3lbs)

9.5 g with BL1850B

Grinding Steel Plate SS400

* All list price shown are for reference only (exclude SST).

* Semua harga yang ditunjukkan adalah untuk rujukan sahaja (tidak termasuk SST). 所有显示的建议零售价仅供参考 (不包括SST)。

Cordless
Tampal Kord Tanpa Kord

LED Flashlight
Lampu Suluh LED
LED/LED

Vacuum Cleaner
Penyedut Vakuum
吸尘器

Drilling / Fastening
Draib / Pasang
钻孔 / 紧固

Impact Drilling / Demolition
Draib / Hancurkan
冲击钻孔 / 拆除加工

Cutting
Memotong
切割

Grinding / Sanding
Pengisar / Hais
磨削 / 打磨

Sawing
Gergaji
锯切

Planing / Routing
Pegyalan / Rongkah
刨削 / 雕刻

Others
Lain-lain
其他

Outdoor Power Equipment
Alatan Kuasa Luar
户外动力设备

Makita
MAKITA

18V **LXT** **Li-ion** Ah 6.0 5.0 4.0 3.0 2.0 1.5

Cordless Drywall Sander

Pelicin Drywall Tanpa Kord 充电式石膏板砂光机

*Masa Penggunaan Berterusan
连续使用时间

Continuous Usage Time
with BL1850B
(Speed dial 3)

35min
(approx.)

* Continuous Usage Time/Work Amount: Actual performance may vary based on application. Masa Penggunaan Berterusan/ Waktu Kerja: Prestasi sebenar mungkin berbeza mengikut aplikasi. 连续使用时间/工作量: 实际使用可能因应用而异。



AWS
Auto-start Wireless System

Sistem permulaan wayarles automatik
无线自动启动系统

Wireless unit is compatible with all supported tools
Unit wayarles serasi dengan semua alat yang disokong
无线设备与所有支持的工具兼容

The wireless activation function enables clean and comfortable operation. By connecting a supported tool to the cleaner, you can run the cleaner automatically along with the switch operation of the tool
Fungsi pengaktifan tanpa wayar membolehkan operasi yang bersih dan selesa. Dengan menyambungkan alat kuasa dengan pembersih, anda boleh menjalankan pembersihan secara automatik dengan operasi suis alat tersebut
无线装置让工作环境更清淨。自动启动无线系统透过蓝牙连接到吸尘器。启动工具吸尘器将自动运行





Aluminum pipe
Paip aluminium 铝管

Variable speed control dial
1,000 - 1,800min⁻¹
Dail kawalan kelajuan ubah 变速控制拨盘

Length adjustable telescopic pipe from 1,100mm to 1,520mm
Pelarasan panjang paip teleskopik dari 1,100mm hingga 1,520mm
可调节伸缩管从1,100mm至1,520mm

Roller
Roller 滚轴

Dust collecting brush
Berus mengumpul habuk 集尘刷



Tool length adjustable for various jobsites
Panjang alat boleh laras untuk pelbagai kerja
工具长度可调节适用于各种工作



Accessories
Aksesori 配件

Pad

Type	Part No.
Soft	199939-3
Medium	199940-8
Hard	199938-5

Abrasive disc 225

Grit	Part No.
40	B-68389
80	B-68395
120	B-68404
180	B-68410
320	B-68426



DSL800Z 225mm (8-7/8")
RM 5,407

Cordless Drywall Sander
Pelicin Drywall Tanpa Kord
充电式石膏板砂光机

- Easy handling by cordless

Standard Equipment: Abrasive Disc, Hex Wrench, Tool Bag

• Z: Without Charger & Battery



Pad diameter Diameter Pad 垫片直径	210mm (8-1/4")
Abrasive Disc Size Saiz Cakera 磨盘尺寸	225mm (8-7/8")
No Load Speed (RPM) Kelajuan Tanpa Beban 回转速数	1,000 - 1,800
Dimensions (L x W x H) Dimensi 体积	1,100-1,520x259x273mm (43-1/4"-59-3/4"x10-1/4"x10-3/4")
Net Weight Berat Bersih 淨重	4.5 - 5.7kg (10.0 - 12.6lbs.)
Continuous Usage Time (approx.) Masa Penggunaan Berterusan 连续使用时间	35 min with BL1850B Speed Dial 3



* All list price shown are for reference only (exclude SST).
* Semua harga yang ditunjukkan adalah untuk rujukan sahaja (tidak termasuk SST). 所有显示的建议零售价仅供参考 (不包括SST)。

Cordless
Tangkas Tanpa Kord

LED Flashlight
Lampu Sinar LED
LED 闪光灯

Vacuum Cleaner
Pembersih Wayarles
吸尘器

Drilling / Fastening
Gredil / Pasak
电钻 / 螺絲

Impact Drilling / Demolition
Gredil / Pasak
电钻 / 螺絲

Cutting
Pemotong
切割机

Grinding / Sanding
Pergasil / Pasah
磨床 / 磨石

Sawing
Gergaji
电锯

Planing / Routing
Pegilapan / Tangkapan
刨床 / 刨刀

Others
Lain-lain
其他

Outdoor Power Equipment
Alatan Kuasa Luar
户外动力工具

Makita
19155



Li-ion Ah 6.0 | 5.0 | 4.0 | 3.0 | 2.0 | 1.5

Cordless Multi Tool

Pemotong dan Pengisar Pelbagai Fungsi Tanpa Kord 充电式多功能切割打磨机



WIDE SELECTION OF ACCESSORIES

Pelbagai pilihan aksesori 广泛的配件选择



Compatible with all OIS accessories (Oscillating Interface System)

DTM51RFEX8 | **DTM51Z**
RM 2,252 | RM 1,163

Cordless Multi Tool
Pemotong dan Pengisar Pelbagai Fungsi Tanpa Kord
充电式多功能切割打磨机



• 12 Angle settings at every 30° from 0° to 360°



Standard Equipment:
DTM51RFEX8: Oscillating multi tool accessories, Tool Box

- RFX8: 1x Rapid Charger, 2x 3.0Ah Battery
- Z: Without Charger, Battery & Carrying Case

*Not applicable for Z model



Oscillations Per Minute (OPM) Kelajuan Ayunan 摆动速度	6,000 - 20,000
Oscillation Angle Sudut Ayunan 摆动角度	Left: 1.6° Right: 1.6° Total: 3.2°
Dimensions (L x W x H) Dimensi 体积	340x80x122mm (13-3/8"x3-1/8"x4-13/16")
Net Weight Berat Bersih 净重	2.0 - 2.4kg (4.4 - 5.3lbs)
Work Amount (approx.) Jumlah Kerja 工作量	40 pcs with BL1850B Cutting

DTM50Z
RM 987

Cordless Multi Tool
Pemotong dan Pengisar Pelbagai Fungsi Tanpa Kord
充电式多功能切割打磨机



• High operating efficiency



Standard Equipment: Hex Wrench

- Z: Without Charger & Battery

Oscillations Per Minute (OPM) Kelajuan Swing 摆动速度	6,000 - 20,000
Dimensions (L x W x H) Dimensi 体积	307x80x122mm (12-1/4"x3-1/8"x4-13/16")
Net Weight Berat Bersih 净重	1.8 - 2.2kg (3.9 - 4.8lbs)
Work Amount (approx.) Jumlah Kerja 工作量	35 pcs with BL1850B Cutting

* All list price shown are for reference only (exclude SST).

* Semua harga yang ditunjukkan adalah untuk rujukan sahaja (tidak termasuk SST). 所有显示的建议零售价仅供参考 (不包括SST)。

Cordless
Tampal Kord 充电式

LED Flashlight
Lampu Suluh LED
LED 手电筒

Vacuum Cleaner
Penyedut Vakuum
吸尘器

Drilling / Fastening
Draib / Pasang
电钻 / 螺丝

Impact Drilling / Demolition
Draib / Hancurkan
电钻 / 电锤

Cutting
Pemotong

Grinding / Sanding
Pengisar / Habis
磨 / 砂

Sawing
Gergaji
电锯

Planing / Routing
Pegaram / Tengam
刨 / 铣

Others
Lain-lain
其他

Outdoor Power Equipment
Alatan Kuasa Luar
户外动力设备





Li-ion Ah 6.0 5.0 4.0 3.0 2.0 1.5

DBO180Z 125mm (5")
RM 792

Cordless Random Orbit Sander

Pelincin Orbit Tanpa Kord
充电式砂光机



- Three speed control switch fast, medium and low

Standard Equipment: Abrasive Paper, Dust Bag

• Z : Without Charger & Battery



Pad Diameter Diameter Pad 垫片直径	123mm (4-7/8")
Abrasive Disc Size Saiz Cakera 磨盘尺寸	125mm (5")
Orbits Per Minute (OPM) Bilangan Putaran 轨道转速	7,000 9,500 11,000
Dimensions (L x W x H) Dimensi 体积	175x123x153mm (6-7/8"x4-7/8"x6")
Net Weight Berat Bersih 净重	1.4 - 1.7kg (3.0 - 3.7lbs)
Continuous Usage Time (approx.) Masa Penggunaan Berterusan 连续使用时间	66 min with BL1850B Low Speed Sanding

Cordless Compound Miter Saw

Gergaji Kompaun Miter Tanpa Kord 充电式斜断锯

LED job light
Lampu LED 工作指示灯



Can be attached with a vacuum cleaner
Boleh dihubungkan dengan alat kuasa
能够连接电动工具

Laser line function
Garis laser sebagai penanda
garisan potong
激光线作为切线引导



Max. cutting capacity (mm) (height x width) with 165mm (6-1/2") saw blade
Kapasiti potongan maksimum dengan menggunakan bilah gergaji 165mm (6-1/2") 最大切割能力 使用165mm (6-1/2") 锯片

Cross Cut Potongan Cross 交错切割	Miter Cut (left & right) Potongan Miter 左右切割	Bevel Cut (left & right) Potongan Bevel 左右斜角切割	Compound Cut Potongan Compound 复合切割
<p>90°</p> <p>46 x 92 (1-13/16" x 3-5/8")</p>	<p>90° 45°</p> <p>Miter: 45° left/ right 46 x 65 (1-13/16" x 2-9/16")</p> <p>Miter: 52° left/ right 46 x 56 (1-13/16" x 2-3/16")</p>	<p>90° 45°</p> <p>Bevel: 45° left 30 x 92 (1-3/16" x 3-5/8")</p> <p>Bevel: 45° right 15 x 92 (9/16" x 3-5/8")</p>	<p>45°</p> <p>Bevel: 45° left Miter: 45° left/ right 30 x 65 (1-3/16" x 2-9/16")</p> <p>Bevel: 45° right Miter: 45° left/ right 15 x 65 (9/16" x 2-9/16")</p>

DLS600Z 165mm (6-1/2")
RM 4,407

Cordless Compound Miter Saw

Gergaji Kompaun Miter Tanpa Kord
充电式斜断锯



- High accuracy & Lightweight

Standard Equipment: TCT Saw Blade (B-56487), Dust Bag, Vertical Vise, Hex Wrench, Triangular Rule

• Z : Without Charger & Battery



Blade Diameter Diameter Bilah 锯片直径	165mm (6-1/2")
Miter Angle Sudut Miter 斜接角	52°L / 52°R
Bevel Angle Sudut Bevel 斜角	46°L / 46°R
Max Cutting Capacity Kapasiti Pemotongan Maksimum 最大切割能力	90° Miter: 46 x 92mm (1-13/16" x 3-5/8") 45° Miter, L/R: 46 x 65mm (1-13/16" x 2-9/16")
No Load Speed (RPM) Kelajuan Tanpa Beban 回转数	5,000
Dimensions (L x W x H) Dimensi 体积	340x400x440mm (13-3/8"x15-3/4"x17-1/4")
Net Weight Berat Bersih 净重	6.3 - 6.6kg (13.9 - 14.6lbs)
Work Amount (approx.) Jumlah Kerja 工作量	625 pcs with BL1850B Sawing (Round Wood Height 15 x 90mm Thick)

DLS713RME | **DLS713Z** 190mm (7-1/2")
RM 5,048 | RM 3,908

Cordless Slide Compound Miter Saw

Gergaji Gelongsor Kompaun Miter Tanpa Kord
充电式斜断锯 (滑动复合式)



- Powerful Makita-built motor

Standard Equipment: TCT Saw Blade (A-B6147), Vertical Vise, Socket Wrench, Triangular Rule, Dust Bag, Holder Set

• RME: 1x Rapid Charger, 2x 4.0Ah Battery
• Z: Without Charger & Battery



Blade Diameter Diameter Bilah 锯片直径	190mm (7-1/2")
Miter Angle Sudut Miter 斜接角	47°L / 57°R
Bevel Angle Sudut Bevel 斜角	45°L / 5°R
Max Cutting Capacity Kapasiti Pemotongan Maksimum 最大切割能力	90°: 52 x 300mm (2-1/16" x 11-3/4") 2,200
No Load Speed (RPM) Kelajuan Tanpa Beban 回转数	2,200
Dimensions (L x W x H) Dimensi 体积	655x430x454mm (25-3/4"x17"x17-7/8")
Net Weight Berat Bersih 净重	12.1kg (26.7lbs)
Work Amount (approx.) Jumlah Kerja 工作量	300 pcs with BL1850B Sawing (Merbau Decking 90 x 19mm)

* All list price shown are for reference only (exclude SST).

* Semua harga yang ditunjukkan adalah untuk rujukan sahaja (tidak termasuk SST). 所有显示的建议零售价仅供参考 (不包括SST)。

Cordless
Target Wood Sander

LED Flashlight
Lampu Cahaya LED
LED 指示灯

Vacuum Cleaner
Penyedut Vakuum
吸尘器

Drilling / Fastening
Gergaji / Pasak
钻孔 / 打钉

Impact Drilling / Demolition
Gergaji / Pasak
冲击钻孔 / 拆除

Cutting
Pemotongan
切割

Grinding / Sanding
Pergasi / Pasak
打磨 / 磨光

Sawing
Gergaji
锯切

Planing / Routing
Penghalus / Tangkapan
刨平 / 封边

Others
Lain-lain
其他

Outdoor Power Equipment
Alatan Kerja Luar
户外动力设备





Li-ion Ah 6.0 5.0 4.0 3.0 2.0 1.5

DHS661RFJ DHS661Z 165mm (6-1/2")
RM 2,798 RM 1,823

Cordless Circular Saw
Gergaji Piring Tanpa Kord
充电式圆锯



- Compact and Lightweight Design for Better Maneuverability

Standard Equipment: TCT Saw Blade (B-63018), Hex Wrench, Rip Fence (Guide Rule), Dust Nozzle

- RFJ: 1x Rapid Charger, 2x 3.0Ah Battery, 1x Makpac Connector Box
- Z: Without Charger, Battery & Carrying Case



*Not applicable for Z model



Blade Diameter Diameter Bilah 锯片直径	165mm (6-1/2")
Hole Diameter Diameter Lubang 孔直径	15.88mm (5/8") 20mm (13/16")
Max Cutting Capacity Kapasiti Pemotongan Maksimum 最大切割能力	90°: 57mm (2-1/4") 45°: 41mm (1-5/8") 50°: 37mm (1-7/16")
No Load Speed (RPM) Kelajuan Tanpa Beban 回转速数	5,000
Max Output Keluaran Maksima 最大输出	680W
Dimensions (L x W x H) Dimensi 体积	270x186x250mm (10-5/8"x7-3/8"x9-7/8")
Net Weight Berat Bersih 净重	2.9 - 3.2kg (6.4 - 7.1lbs.)
Work Amount Jumlah Kerja 工作量	200 pcs with BL1850B Sawing with EFFICUT Blade, 90° cut SPF 2 x 10 (Thickness 38mm, Width 89mm)

DHS680RMJ DHS680RFJ DHS680Z 165mm (6-1/2")
RM 2,553 RM 2,390 RM 1,415

Cordless Circular Saw
Gergaji Piring Tanpa Kord
充电式圆锯

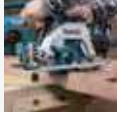

- High-efficiency BL motor provides higher power

Standard Equipment: TCT Saw Blade (B-63018), Hex Wrench, Rip Fence (Guide Rule)

- RMJ: 1x Rapid Charger, 2x 4.0Ah Battery, 1x Makpac Connector Box
- RFJ: 1x Rapid Charger, 2x 3.0Ah Battery, 1x Makpac Connector Box
- Z: Without Charger, Battery & Carrying Case



*Not applicable for Z model



VIDEO CLIP

DHS680

Models and specs may vary by country

Blade Diameter Diameter Bilah 锯片直径	165mm (6-1/2")
Max Cutting Capacity Kapasiti Pemotongan Maksimum 最大切割能力	90°: 57mm (2-1/4") 45°: 41mm (1-5/8") 50°: 37mm (1-7/16")
No Load Speed (RPM) Kelajuan Tanpa Beban 回转速数	5,000
Dimensions (L x W x H) Dimensi 体积	350x170x238mm (13-3/4"x6-11/16"x9-3/8")
Net weight Berat Bersih 净重	3.0 - 3.3kg (6.6 - 7.3lbs)
Work Amount Jumlah Kerja 工作量	170 pcs with BL1850B Sawing with Standard Blade, 90° cut SPF 2 x 10 (Thickness 38mm, Width 89mm)

DHS630RME DHS630RFE DHS630Z 165mm (6-1/2")
RM 3,785 RM 3,620 RM 2,645

Cordless Circular Saw
Gergaji Piring Tanpa Kord
充电式圆锯



- Cut up to 66mm thick wood with a single stroke

Standard Equipment: TCT Saw Blade (D-51079), Hex Wrench, Rip Fence (Guide Rule)

- RME: 1x Rapid Charger, 2x 4.0Ah Battery
- RFE: 1x Rapid Charger, 2x 3.0Ah Battery
- Z: Without Charger, Battery & Carrying Case



*Not applicable for Z model



Blade Diameter Diameter Bilah 锯片直径	165mm (6-1/2")
Max Cutting Capacity Kapasiti Pemotongan Maksimum 最大切割能力	90°: 66mm (2-5/8") 45°: 46mm (1-13/16")
No Load Speed (RPM) Kelajuan Tanpa Beban 回转速数	3,100
Dimensions (L x W x H) Dimensi 体积	346x220x247mm (13-5/8"x8-5/8"x9-3/4")
Net weight Berat Bersih 净重	3.0 - 3.4kg (6.6 - 7.5lbs)
Work Amount Jumlah Kerja 工作量	260 pcs with BL1850B Sawing (Mixed Wood 2" x 2")

DSS610Z 165mm (6-1/2")
RM 943

Cordless Circular Saw
Gergaji Piring Tanpa Kord
充电式圆锯



- Built-in dust blower directs sawdust away from cutting line

Standard Equipment: Carbide-Tipped Saw Blade, Rip Fence (Guide Rule), Hex Wrench

- Z: Without Charger & Battery



Blade Diameter Diameter Bilah 锯片直径	165mm (6-1/2")
Max Cutting Capacity Kapasiti Pemotongan Maksimum 最大切割能力	90°: 0-57mm (2-1/4")/ 45°: 0-40mm (1-9/16") 50°: 0-36mm (1-7/16")
No Load Speed (RPM) Kelajuan Tanpa Beban 回转速数	3,700
Dimensions (L x W x H) Dimensi 体积	347x202x228mm (13-5/8"x8"x9")
Net weight Berat Bersih 净重	3.0 - 3.4kg (6.7 - 7.5lbs)
Work Amount Jumlah Kerja 工作量	230 pcs with BL1850B Sawing (Mixed Wood 2" x 2")

DSS501Z 136mm (5-3/8")
RM 908

Cordless Circular Saw
Gergaji Piring Tanpa Kord
充电式圆锯



- Compact and lightweight design

Standard Equipment: Carbide-Tipped Saw Blade, Hex Wrench, Rip Fence (Guide Rule)

- Z: Without Charger & Battery



Blade Diameter Diameter Bilah 锯片直径	136mm (5-3/8")
Max Cutting Capacity Kapasiti Pemotongan Maksimum 最大切割能力	90°: 51mm (2") 45°: 35mm (1-3/8")
No Load Speed (RPM) Kelajuan Tanpa Beban 回转速数	3,600
Dimensions (L x W x H) Dimensi 体积	364x183x201mm (14-3/8"x7-1/4"x7-7/8")
Net Weight Berat Bersih 净重	2.4 - 2.7kg (5.3 - 6.0lbs)
Work Amount Jumlah Kerja 工作量	230 pcs with BL1850B Sawing (Mixed Wood 2" x 2")

* All list price shown are for reference only (exclude SST).

* Semua harga yang ditunjukkan adalah untuk rujukan sahaja (tidak termasuk SST). 所有显示的建议零售价仅供参考 (不包括SST)。

Cordless
Tampal Kord Tanpa Kord

LED Flashlight
Lampu Suluh LED
LED/NIRAU

Vacuum Cleaner
Penyedut Vakuum
吸尘器

Drilling / Fastening
Gergaji / Pengikat
电钻 / 螺丝

Impact Drilling / Demolition
Gergaji / Pemusnah
电钻 / 电锤

Cutting
Pemotong
电锯

Grinding / Sanding
Pengisar / Habis
电磨 / 砂纸

Sawing
Gergaji
电锯

Planing / Routing
Pegangan / Tengam
电刨 / 电铣

Others
Lain-lain
其他

Outdoor Power Equipment
Alatan Kerja Luar
电园工具

Makita
LXT



Li-ion Ah 6.0 5.0 4.0 3.0 2.0 1.5

DJR187RME | **DJR187RFE** | **DJR187Z**
 RM 2,302 | RM 2,138 | RM 1,163

Cordless Recipro Saw
 Gergaji Resipro Tanpa Kord
 充电式往复锯

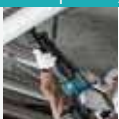

- BL Brushless DC motor with high power

Standard Equipment: Recipro Saw Blades 2pcs (B-05175 & B-05169)

- RME: 1x Rapid Charger, 2x 4.0Ah Battery
- RFE: 1x Rapid Charger, 2x 3.0Ah Battery
- Z: Without Charger, Battery & Carrying Case

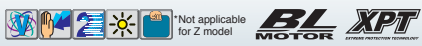

Length of Stroke Panjang Strok 冲程长度	32mm (1-1/4")
Strokes Per Minute (SPM) Kelajuan Strok 冲程速度	High: 0 - 3,000 Low: 0 - 2,300
Capacity Kapasiti 能力	Pipe: 130mm (5-1/8") Wood: 255mm (10")
Dimensions (L x W x H) Dimensi 体积	439x83x231mm (17-1/4"x3-1/4"x9-1/8")
Net Weight Berat Bersih 净重	3.4 - 3.8kg (7.6 - 8.3lbs)
Work Amount Jumlah Kerja 工作量	65 pcs with BL1850B Cutting (Steel Pipe Ø34 x 3mm)

DJR188Z
 RM 1,050

Cordless Recipro Saw
 Gergaji Resipro Tanpa Kord
 充电式往复锯



- High cutting speed (Max 3,000 SPM) provide higher cutting efficiency

Standard Equipment: Recipro Saw Blades 2pcs (B-20432 & B-20404)

- Z: Without Charger & Battery



Length of Stroke Panjang Strok 冲程长度	20mm (13/16")
Strokes Per Minute (SPM) Kelajuan Strok 冲程速度	0 - 3,000
Capacity Kapasiti 能力	Pipe : 130mm (5-1/8") Wood: 255mm (10")
Dimensions (L x W x H) Dimensi 体积	BL1815N: 316x81x203mm (12-1/2"x3-3/16"x8") BL1850B: 316x81x220mm (12-1/2"x3-3/16"x8-5/8")
Net Weight Berat Bersih 净重	2.6 - 2.9kg (5.7 - 6.4lbs)
Work Amount Jumlah Kerja 工作量	58 pcs with BL1850B Cutting (Steel Pipe Ø34 x 3mm)

DJR186RME | **DJR186RFE** | **DJR186Z** 441
 RM 2,043 | RM 1,880 | RM 905

Cordless Recipro Saw
 Gergaji Resipro Tanpa Kord
 充电式往复锯



- Toolless blade change; redesign of blade clamp makes it easier to remove a blade

Standard Equipment: Recipro Saw Blades 2pcs (B-05175 & B-05169)

- RME: 1x Rapid Charger, 2x 4.0Ah Battery
- RFE: 1x Rapid Charger, 2x 3.0Ah Battery
- Z: Without Charger, Battery & Carrying Case



Length of Stroke Panjang Strok 冲程长度	32mm (1-1/4")
Strokes Per Minute (SPM) Kelajuan Strok 冲程速度	0 - 2,800
Capacity Kapasiti 能力	Pipe : 130mm (5-1/8") Wood: 255mm (10")
Dimensions (L x W x H) Dimensi 体积	486x81x223mm (19-1/8"x3-3/16"x8-3/4")
Net Weight Berat Bersih 净重	3.5 - 3.8kg (7.6 - 8.3lbs)
Work Amount Jumlah Kerja 工作量	60 pcs with BL1850B Cutting (Steel Pipe Ø34 x 3mm)

DJR181RFE 441
 RM 1,853

Cordless Recipro Saw
 Gergaji Resipro Tanpa Kord
 充电式往复锯



- Toolless blade change system enables fast, one-handed blade changes

Standard Equipment: Recipro Saw Blade

- RFE: 1x Rapid Charger, 2x 3.0Ah Battery



Length of Stroke Panjang Strok 冲程长度	28mm (1-1/8")
Strokes Per Minute (SPM) Kelajuan Strok 冲程速度	0 - 2,900
Capacity Kapasiti 能力	Pipe : 130mm (5-1/8") Wood: 255mm (10")
Dimensions (L x W x H) Dimensi 体积	499x91x234mm (19-5/8"x3-5/8"x9-1/4")
Net Weight Berat Bersih 净重	3.5kg (7.7lbs)
Work Amount Jumlah Kerja 工作量	70 pcs with BL1850B Cutting (SPF Material 2x10")

DJR183Z
 RM 952

Cordless Recipro Saw
 Gergaji Resipro Tanpa Kord
 充电式往复锯



- Dual-position on/off switch allows for either paddle or trigger switch operation

Standard Equipment: Recipro Saw Blades 2pcs

- Z: Without Charger & Battery



Capacity Panjang Strok 冲程长度	Pipe : 50mm (2") Wood: 50mm (2")
Length of Stroke Kelajuan Strok 冲程速度	13mm (1/2")
Strokes Per Minute (SPM) Kapasiti 能力	0-3,000
Dimensions (L x W x H) Dimensi 体积	392x81x209mm (15-1/2"x3-3/16"x8-1/4")
Net weight Berat Bersih 净重	1.5 - 1.7kg (3.3 - 3.8lbs)
Work Amount Jumlah Kerja 工作量	56 pcs with BL1850B Cutting (SPF Material 2x10")

* All list price shown are for reference only (exclude SST).

* Semua harga yang ditunjukkan adalah untuk rujukan sahaja (tidak termasuk SST). 所有显示的建议零售价仅供参考 (不包括SST)。

Cordless
Tanpa Kord Tanpa Kord

LED Flashlight
Lampu Sinar LED
LED 照明灯

Vacuum Cleaner
Penyedut Vakuum
吸尘器

Drilling / Fastening
Gergaji / Pasak
电钻 / 螺絲

Impact Drilling / Demolition
Gergaji / Pasak
电钻 / 螺絲

Cutting
Pemotong
切割机

Grinding / Sanding
Pergasi / Pasak
磨光 / 螺絲

Sawing
Gergaji
电锯

Planing / Routing
Pergasi / Pasak
电钻 / 螺絲

Others
Lain-lain
其他

Outdoor Power Equipment
Alatan Kerja Luar
户外动力工具

Makita
1 INT

18V

LXT

Li-ion Ah 6.0 | 5.0 | 4.0 | 3.0 | 2.0 | 1.5

Cordless Jig Saw

Gergaji Jig Tanpa Kord 充电式线锯机

As Powerful As Coded Jigsaws

Berkuasa seperti Jig Saw berkord 相当于有线线锯机的强力



DJV182RME | **DJV182RFE** | **DJV182Z**
RM 2,615 | RM 2,452 | RM 1,477

Cordless Jig Saw

Gergaji Jig Tanpa Kord
充电式线锯机



- Powerful Brushless DC motor

Standard Equipment: Jig Saw Blade Set
(No. BR-10, BR-13, B-22, 2pcs each), Cover Plate,
Anti-Splintering Device, Hex Wrench

- RME: 1x Rapid Charger, 2x 4.0Ah Battery
- RFE: 1x Rapid Charger, 2x 3.0Ah Battery
- Z: Without Charger, Battery & Carrying Case



*Not applicable
for Z model



VIDEO CLIP
Models and specs
may vary by country

DJV181/DJV182

DJV181RFE | **DJV181Z**
RM 2,452 | RM 1,477

Cordless Jig Saw

Gergaji Jig Tanpa Kord
充电式线锯机



- Excellent performance provides higher productivity

Standard Equipment: Jig Saw Blade Set
(No. BR-10, BR-13, B-22, 2pcs each),
Cover Plate, Anti-Splintering Device, Hex Wrench

- RFE: 1x Rapid Charger, 2x 3.0Ah Battery
- Z: Without Charger, Battery & Carrying Case



*Not applicable
for Z model



VIDEO CLIP
Models and specs
may vary by country

DJV181/DJV182

DJV180RFE | **DJV180Z**
RM 2,188 | RM 1,212

440

Cordless Jig Saw

Gergaji Jig Tanpa Kord
充电式线锯机



- Low vibration and low noise

Standard Equipment: Jig Saw Blade Set
(No. BR-10, BR-13, B-22, 2pcs each), Cover Plate,
Anti-Splintering Device, Hex Wrench

- RFE: 1x Rapid Charger, 2x 3.0Ah Battery
- Z: Without Charger, Battery & Carrying Case



*Not applicable
for Z model



DSD180Z
RM 1,468

Cordless Drywall Saw

Gergaji Drywall Tanpa Kord
充电式石膏板切割器



- Ideal for cutting holes in drywalls when setting
ceiling lights, air vents etc

Standard Equipment: Blade, Blade Cover,
Base Cover, Hex Wrench

- Z: Without Charger & Battery



VIDEO CLIP
Models and specs
may vary by country

DSD180

Capacity Kapasiti 能力	Wood: 135mm (5-5/16") Steel: 10mm (3/8") 26mm (1")
Length of Stroke Panjang Strok 冲程长度	
Strokes Per Minute (SPM) Kelajuan Strok 冲程速度	800 - 3,500
Dimensions (L x W x H) Dimensi 体积	266x77x208mm (10-1/2"x3"x8-3/16")
Net Weight Berat Bersih 净重	2.4 - 2.7kg (5.2 - 5.9lbs)
Work Amount Jumlah Kerja 工作量	266 pcs with BL1850B Sawing with Blade B-10 Plywood (Thickness 12mm x Length 300mm)

Capacity Kapasiti 能力	Wood: 135mm (5-5/16") Steel: 10mm (3/8") 26mm (1")
Length of Stroke Panjang Strok 冲程长度	
Strokes Per Minute (SPM) Kelajuan Strok 冲程速度	800 - 3,500
Dimensions (L x W x H) Dimensi 体积	298x77x189mm (11-3/4"x3"x7-7/16")
Net Weight Berat Bersih 净重	2.3 - 2.6kg (5.0 - 5.7lbs)
Work Amount Jumlah Kerja 工作量	266 pcs with BL1850B Sawing with Blade B-10 Plywood (Thickness 12mm x Length 300mm)

Capacity Kapasiti 能力	Wood: 135mm (5-5/16") Steel: 10mm (3/8") 26mm (1")
Length of Stroke Panjang Strok 冲程长度	
Strokes Per Minute (SPM) Kelajuan Strok 冲程速度	0-2,600
Dimensions (L x W x H) Dimensi 体积	257x73x208mm (10-1/8"x2-7/8"x8-3/16")
Net Weight Berat Bersih 净重	2.7 - 3.0kg (6.0 - 6.7lbs)
Work Amount Jumlah Kerja 工作量	216 pcs with BL1850B Sawing with Blade B-10 Plywood (Thickness 12mm x Length 300mm)

Strokes Per Minute (SPM) Kelajuan Strok 冲程速度	0 - 6,000
Length of Stroke Panjang Strok 冲程长度	6mm (1/4")
Capacity Kapasiti 能力	Drywall: 30mm (1-3/16") Wood: 15mm (9/16")
Dimensions (L x W x H) Dimensi 体积	263x79x291mm (10-3/8"x3-1/8"x11-3/8")
Net weight Berat Bersih 净重	1.7 - 2.0kg (3.8 - 4.5lbs)
Work Amount Jumlah Kerja 工作量	360 m with BL1850B Cutting (Gypsum Board Thickness 12.5mm/1ply)

* All list price shown are for reference only (exclude SST).

* Semua harga yang ditunjukkan adalah untuk rujukan sahaja (tidak termasuk SST). 所有显示的建议零售价仅供参考 (不包括SST)。

Cordless
Tanpa Kord 充电式LED Flashlight
Lampu Suluh LED
LED 闪光灯Vacuum Cleaner
Penyedut Vakuum
吸尘器Drilling / Fastening
Dron / Pengikat
电钻 / 螺丝Impact Drilling / Demolition
Dron / Pemusnah
电钻 / 电锤Cutting
Pemotong
切割Grinding / Sanding
Pengisar / Hais
磨 / 砂Sawing
Gergaji
锯Planing / Routing
Pegaram / Tengam
刨 / 铣Others
Lain-lain
其他Outdoor Power Equipment
Alatan Kuasa Luar
户外动力设备Makita
MAKITA

18V

LXT

Li-ion Ah 6.0 5.0 4.0 3.0 2.0 1.5

Cordless Planer

Pengetam Tanpa Kord 充电式电刨

*Jumlah Kerja 工作量
Work Amount
with BL1850B
(0.5mm Cutting Depth)

76m
(approx.)

* Continuous Usage Time/ Work Amount:
Actual performance may vary based on application.

Masa Penggunaan Berterusan/ Jumlah Kerja: Prestasi sebenar
— bergantung berbeza mengikut aplikasi
连续使用时间/ 工作量: 实际表现可能因应用情况而异。

Planing Width
Lebar Pengetaman 刨削宽度

82
mm

Ergonomically designed and rubberized handle

Pemegang getah yang direka secara ergonomik meningkatkan keselesaan
符合人体工程学设计的橡胶柔软握柄

Knob with click stops

Tombol pelarasan 调节旋钮

Rigid aluminium die-cast bracket

Pendakap die-casting aluminium
高刚性铝压铸支架

Foot on base plate

protects workpiece and blade from scratches and damages even if the machine is put on workpiece before drum comes to a complete halt

Kaki boleh maningkatkan plat asas untuk melindungi bilah dan benda kerja, mengelakkan calar dan kerosakan
支脚可抬高底座保护刨刀和工作, 可防止刮伤和损坏

Front base with 3 chamfering grooves

Planer depan menyediakan tiga alur berbentuk V yang berlainan
前刨板有3个V型槽提供三个不同的凹槽

About 4mm About 1.4mm About 3mm

DKP181RTJ **DKP181Z** 82mm (3-1/4")
RM 3,425 RM 2,140

Cordless Planer
Pengetam Tanpa Kord
充电式电刨

• Auto-start Wireless System (AWS) connects to vacuum cleaner with Bluetooth

Standard Equipment: Planer Blade, Blade Gauge, Guide Rule, Depth Guide, Socket Wrench, Sharpening Holder Assembly (for resharpenable blade)

• RTJ: 1x Rapid Charger, 2x 5.0Ah Battery, 1x Makpac Connector Box
• Z: Without Charger, Battery & Carrying Case



*Not applicable for Z model

BL MOTOR **ADT** **AWS**
Auto-Start Wireless System



NEW
BARU / 新

DKP180RFE **DKP180Z** 82mm (3-1/4")
RM 2,052 RM 1,075

Cordless Planer
Pengetam Tanpa Kord
充电式电刨

• Easy blade setting system for fast blade installation

Standard Equipment: Planer Blade, Blade Gauge, Guide Rule, Socket Wrench

• RFE: 1x Rapid Charger, 2x 3.0Ah Battery
• Z: Without Charger, Battery & Carrying Case



*Not applicable for Z model

BL MOTOR **ADT** **AWS**
Auto-Start Wireless System



Planing Width 82mm (3-1/4")
Lebar Pelan 刨削宽度

Planing Depth 3mm (1/8")
Kedalaman Pelan 刨削深度

No Load Speed (RPM) 12,000
Kelajuan Tanpa Beban 回转速数

Dimensions (L x W x H) 366x156x166mm
Dimensi 体积

Net Weight 3.3 - 3.6kg (7.3 - 7.9lbs.)
Berat Bersih 净重

Planing Width 82mm (3-1/4")
Lebar Pelan 刨削宽度

Planing Depth 2.0mm (5/64")
Kedalaman Pelan 刨削深度

No Load Speed (RPM) 14,000
Kelajuan Tanpa Beban 回转速数

Dimensions (L x W x H) 333x157x160mm
Dimensi 体积

Net weight 3.2 - 3.5kg (7.1 - 7.9lbs.)
Berat Bersih 净重

Work Amount 91 m with BL1850B
Jumlah Kerja 工作量

Wood Thickness 1mm
木材厚度

* All list price shown are for reference only (exclude SST).

* Semua harga yang ditunjukkan adalah untuk rujukan sahaja (tidak termasuk SST). 所有显示的建议零售价仅供参考 (不包括SST)。

Cordless
Tanpa Kord 充电式

LED Flashlight
Lampu Cahaya LED
LED照明灯

Vacuum Cleaner
Penyedut Vakuum
吸尘器

Drilling / Fastening
Guaian / Pasang
钻孔 / 紧固

Impact Drilling / Demolition
Guaian / Pasang
冲击钻 / 拆除

Cutting
Pemotongan
切割

Grinding / Sanding
Pergasilan / Pasir
磨削 / 打磨

Sawing
Gugil
锯切

Planing / Routing
Pegilahan / Tonggolan
刨削 / 铣削

Others
Lain-lain
其他

Outdoor Power Equipment
Alatan Kerja Luar
户外动力设备

Makita
1 INTL

18V

LXT

Li-ion Ah 6.0 5.0 4.0 3.0 2.0 1.5

DPJ180Z

RM 1,232

430

Cordless Plate Joiner

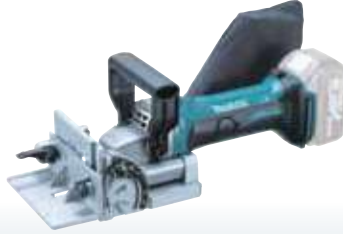
Mesin Kayu Tanpa Kord
充电式木工接合机

- Easy blade setting system for fast blade installation

Standard Equipment: Cutter Blade, Angle Guide,
Lock Nut Wrench, Set Plate, Dust Bag

- Z: Without Charger & Battery



DCO180Z 6.35mm (1/4")

RM 662

430

Cordless Cut-Out Tool

Mesin Pemotong Tanpa Kord
充电式石膏板开孔机

- Accepts both 1/8" and 1/4" bits

Standard Equipment: Drywall Guide Bit x2, Collet Nut,
Collet Cone 6.35mm (1/4")

- Z: Without Charger & Battery



DVP180Z

RM 2,632

Cordless Vacuum Pump

Pam Vakum Tanpa Kord
充电式真空泵

- For air purge during installation of room
air conditioner

Standard Equipment: Vacuum Pump Oil, Adapter

- Z: Without Charger & Battery

DRT50Z | DRT50ZJX9 6mm (1/4"), 8mm (3/8")

RM 1,192

RM 2,127

Cordless Trimmer

Mesin Perapi Tanpa Kord
充电式修边机

- Faster Trimming than Corded

Standard Equipment: Trimmer Base Assembly (196612-6),
Collet Cone, Dust Nozzle, Straight Guide Assembly, Wrench x2

- Z : Without Charger, Battery & Carrying Case
- ZJX9: Tilt Base Assembly (195561-4), Plunge Base Assembly (195563-0),
Side Grip, Templet Guide, Guide Rail Adapter Set, Guide Holder Set,
Makpac Connector Box, Without Charger & Battery

Not applicable for Z model



Trimmer Base Assembly
For DRT50ZJX9 only

Blade Diameter Diameter Bilah 锯片直径	100mm (4")
Max Cutting Depth Kedalaman Pemotongan Maksimum 最大切割深度	20mm (3/4")
No Load Speed (RPM) Kelajuan Tanpa Beban 回转数	6,500
Dimensions (L x W x H) Dimensi 体积	351x139x149mm (13-3/4"x5-1/2"x5-7/8")
Net weight Berat Bersih 淨重	2.8 - 3.1kg (6.2 - 6.8lbs)
Work Amount Jumlah Kerja 工作量	333 pcs with BL1850B Biscuit (60 x 23 x 4) Cutting Slot 12.3mm

Capacity Kapasiti 能力	Collet : 3.18mm (1/8") or 6.35mm (1/4")
No Load Speed (RPM) Kelajuan Tanpa Beban 回转数	30,000
Dimensions (L x W x H) Dimensi 体积	296x77x118mm (11-5/8"x3"x4-5/8")
Net weight Berat Bersih 淨重	1.5 - 1.8kg (3.3 - 4.0lbs)
Work Amount Jumlah Kerja 工作量	225 m with BL1850B 6.35mm Bit Cutting Plaster Board 1.2 x 800mm

Flow Rate Kadar Aliran 流量	50L/min
Ultimate Vacuum Tahap Maksimum Vakum 最大真空度	20Pa (150 microns)
Motor Speed Kelajuan Motor 马达速度	3,840min ⁻¹
Oil Tank Capacity Kapasiti Tangki Minyak 润滑油箱	115mL
Inlet Port Pelabuhan Inlet 进气管直径	5/16"
Dimensions (L x W x H) Dimensi 体积	265x93x175mm (10-3/8"x3-5/8"x6-7/8")
Net Weight Berat Bersih 淨重	3.5kg
Continuous Usage Time Masa Penggunaan Berterusan 连续使用时间	50 min with BL1850B

Collet Capacity Kapasiti Collet 夹头直径	6mm, 8mm or 1/4", 3/8"
No Load Speed (RPM) Kelajuan Tanpa Beban 回转数	10,000 - 30,000
Plunge Capacity Kapasiti Plunge 能力	Trimmer Base: 0 - 40mm (0" - 1-9/16") Plunge Base: 0 - 35mm (0" - 1-3/8")
Dimensions (L x W x H) Dimensi 体积	134x89x226mm (5-1/4"x3-1/2"x8-7/8")
Net Weight Berat Bersih 淨重	1.8 - 2.1kg (3.9 - 4.6lbs)
Work Amount Jumlah Kerja 工作量	83 m with BL1850B Routing 06 x 4mm



Trimmer Base Assembly (Optional)

Trimmer Base
Part No. 196612-6



Plunge Base
Part No. 195563-0
(Optional)



Tilt Base
Part No. 195561-4
(Optional)



Offset Base
Part No. 196922-1
(Optional)

* All list price shown are for reference only (exclude SST).

* Semua harga yang ditunjukkan adalah untuk rujukan sahaja (tidak termasuk SST). 所有显示的建议零售价仅供参考 (不包括SST)。



Cordless Brad Nailer

Mesin Pemaku Tanpa Kord 充电式打钉机

*Jumlah Kerja 工作量

Work Amount
with BL1850B
(18Ga Brad Nail)

4,000 pcs
(approx.)

* Continuous Usage Time/ Work Amount:
Actual performance may vary based on application.
Masa Penggunaan Berterusan/ Jumlah Kerja: Prestasi sebenar
mungkin berbeza mengikut aplikasi.
连续使用时间/ 工作量: 实际使用可能因应用情况而异。



Nail outlet port placed in the center of the contact top
allows for easy aiming for precision nail placement

Pelabuhan keluar kuku yang diletakkan di tengah bahagian sentuhan membolehkan memudahkan penempatan paku ketepatan yang mudah

位于接触顶部中心的钉子出口允许容易地瞄准精确的钉子放置



LED job light
Lampu kerja LED LED工作灯

with window for check of remaining nails
Lihat jumlah baki melalui tingkap tontonan
可透过观看视窗看剩余钉针量

DFN350Z

RM 3,672

Cordless Brad Nailer
Mesin Pemaku Tanpa Kord
充电式打钉机



• Ideal for Light Duty Applications such as Fastening Chamfer Strip to Concrete Form Plywood Wall

Standard Equipment: Safety Goggles, Nose Adapter, Hex Wrench, Belt Clip

• Z : Without Charger & Battery



Capacity Kapasiti 能力	Length: 15 - 35mm (5/8" - 1-3/8")
Magazine Capacity Bilangan Staples 装钉个数	Gauge: 18Ga
Dimensions (L x W x H) Dimensi 体积	257x79x228mm (10-1/8"x3-1/8"x9")
Net Weight Berat Bersih 净重	2.1 - 2.4kg (4.6 - 5.3lbs.)
Work Amount (approx.) Jumlah Kerja 工作量	4000pcs with BL1850B

Accessories (optional)			
Description	Size	Pcs/ Box	Part No.
Brad Nail 15mm (5/8")	F15	5,000	B-04307
Brad Nail 20mm (3/4")	F20	5,000	B-04313
Brad Nail 25mm (1")	F25	5,000	B-04329
Brad Nail 30mm (1-3/16")	F30	5,000	B-04335
Brad Nail 35mm (1-3/8")	F35	5,000	B-04357

DPT353Z

RM 2,560

Cordless Pin Nailer
Mesin Pemaku Tanpa Kord
充电式打钉机



• Shoots 6,400 nails on a single full BL1860B charge

Standard Equipment: Nose Adapter, Safety Goggles, Belt Clip

• Z : Without Charger & Battery



Capacity Staple 钉种	Length: 15, 18, 25, 30, 35mm (5/8", 11/16", 1", 1-3/16", 1-3/8")
Magazine Capacity Bilangan Staples 装钉个数	Dia.: 0.6mm (1/32")
Dimensions (L x W x H) Dimensi 体积	Gauge: 23Ga
Net Weight Berat Bersih 净重	257x79x226mm (9-7/8"x3-5/8"x8-7/8")
Work Amount (approx.) Jumlah Kerja 工作量	2.0 - 2.3kg (4.4 - 5.1lbs)
	5300 pcs Pin Nail with BL1850B

Accessories (optional)			
Description	Size	Pcs/ Box	Part No.
Pin Nail 18mm (11/16")	P18	10,000	F-31825
Pin Nail 25mm (1")	P25	10,000	F-31838
Pin Nail 30mm (1-3/16")	P30	10,000	F-31841
Pin Nail 35mm (1-3/8")	P35	10,000	F-31854

DST221Z

RM 1,983

Cordless Stapler
Stapler Tanpa Kord
充电式钉枪



• Compact and powerful stapler can drive a wide range of 10mm staple lengths

Standard Equipment: Safety Goggles, Hook

• Z : Without Charger & Battery



Staple Staple 钉种	Width: 10mm (3/8")
Magazine Capacity Bilangan Staples 装钉个数	Length: 10, 13, 16, 19, 22mm (3/8", 1/2", 5/8", 3/4", 7/8")
Dimensions (L x W x H) Dimensi 体积	Gauge: 0.6 x 1.2mm (1/32" x 1/16")
Net Weight Berat Bersih 净重	251x91x212mm (9-7/8"x3-5/8"x8-3/8")
Work Amount (approx.) Jumlah Kerja 工作量	2.1 - 2.4kg (4.7 - 5.3lbs)
	3000 pcs with BL1850B Stapler Width 10mm

Accessories (optional)			
Description	Length	Pcs/ Box	Part No.
Staple 1010HD	10mm (3/8")	5,040	F-32647
Staple 1013HD	13mm (1/2")	5,040	F-32650
Staple 1016HD	16mm (5/8")	5,040	F-32663
Staple 1019HD	19mm (3/4")	5,040	F-32676
Staple 1022HD	22mm (7/8")	5,040	F-32689

* All list price shown are for reference only (exclude SST).

* Semua harga yang ditunjukkan adalah untuk rujukan sahaja (tidak termasuk SST). 所有显示的建议零售价仅供参考 (不包括SST)。

Cordless
Targeted for use

LED Flashlight
Lampu Cahaya LED
LED工作灯

Vacuum Cleaner
Penyedut Vakuum
吸尘器

Drilling / Fastening
Guares / Pasang
钻孔 / 固定

Impact Drilling / Demolition
Guares / Pasang
钻孔 / 拆除

Cutting
Pemotong
切割

Grinding / Sanding
Pergasil / Pasah
磨削 / 打磨

Sawing
Gergaji
锯切

Planing / Routing
Pegilatan / Tangkapan
刨平 / 封边

Others
Lain-lain
其他

Outdoor Power Equipment
Alatan Kerja Luar
户外工具

makita
- IN THE -



Cordless Hedge Trimmer

Pemangkas Tanaman Pagar Tanpa Kord 充电式篱笆修剪机

Chip receiver
Suis Pemicu 扳机开关

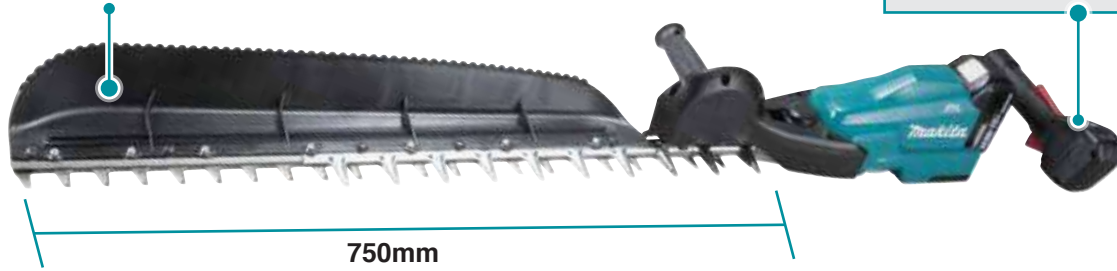

750mm

3-speed

- High : 4,400 SPM
- Medium : 3,600 SPM
- Low : 2,000 SPM

Light weight
Ringan 轻量

3.9kg
with BL1850B 5.0Ah Battery

Optimum blade shape for smooth cutting

Bentuk optimum bilah untuk pemotongan licin 最佳刀片形状，可平滑切割



Sharp edge blades:

Bilah tajam 锋利的刀刃
Upper blade...curving downward
Lower blade...curving upward

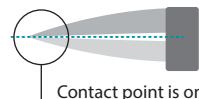

Contact point is only both tips
接触点只是两个提示

Twigs are caught easily and held firmly

Ranting ditangkap dengan mudah dan dipegang dengan kuat 树枝很容易被抓住并坚定地坚持

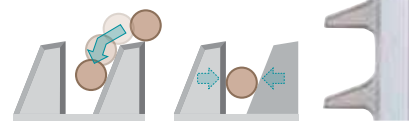

Reverse rotation system

Sistem putaran terbalik 反转系统

for freeing the blade when it is jammed by thick branches

Sistem putaran terbalik untuk membebaskan bilah apabila ia tersekat oleh dahan tebal 反转系统当，刀片被粗大的树枝堵塞时释放刀片

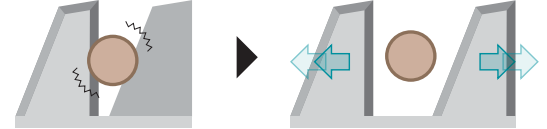

DUH754SRT | **DUH754SZ** 750mm (29-1/2")
RM 4,275 | RM 3,463

Cordless Hedge Trimmer
Pemangkas Tanaman Pagar Tanpa Kord
充电式篱笆修剪机



- Excellent balance of high power and lightweight

Standard Equipment: Blade Cover, Chip Receiver, Safety Goggles

- RT: 1x Rapid Charger, 1x 5.0Ah Battery
- Z: Without Charger & Battery



Blade Length Panjang bilah 刀片长度	750mm (29-1/2")
Strokes Per Minute (SPM) Kelajuan Strok 冲程速度	High: 4,400 Med: 3,600 Low: 2,000
Tooth Spacing Selang Gigi 牙齿间隔	35mm (1-3/8")
Max Cutting Capacity Kapasiti Pemotongan Maksimum 最大切割能力	23.5mm (15/16")
Dimensions (L x W x H) Dimensi 体积	1,200x282x143mm (47-1/4"x11-1/8"x5-5/8")
Net Weight Berat Bersih 净重	3.4 - 3.9kg (7.5 - 8.6lbs.)
Continuous Usage Time (approx.) Masa Penggunaan Berterusan 连续使用时间	High: 54min Med: 66min Low: 158min with BL1850B

DUH601Z 600mm (23-5/8")
RM 1,905

Cordless Hedge Trimmer
Pemangkas Tanaman Pagar Tanpa Kord
充电式篱笆修剪机



- 5-Position rotating rear handle for increased comfort during vertical and angle trimming

Standard Equipment: Blade Cover, Safety Goggles

- Z: Without Charger & Battery



QR Code
DUH601

VIDEO CLIP
Models and specs may vary by country

Blade Length Panjang bilah 刀片长度	600mm (23-5/8")
Strokes Per Minute (SPM) Kelajuan Strok 冲程速度	High: 0 - 4,400 Med: 0 - 3,600 Low: 0 - 2,000
Max Cutting Capacity Kapasiti Pemotongan Maksimum 最大切割能力	23.5mm (15/16")
Tooth Spacing Selang Gigi 牙齿间隔	35mm (1 - 3/8")
Dimensions (L x W x H) Dimensi 体积	1,121x192x225mm (44-1/8"x7-1/2"x8-7/8")
Net Weight Berat Bersih 净重	3.8 - 4.5kg (8.4 - 9.8lbs.)
Continuous Usage Time (approx.) Masa Penggunaan Berterusan 连续使用时间	High - 45min Low - 165min with BL1850B

DUH523RME | **DUH523RFE** | **DUH523Z** 520mm (20-1/2")
RM 1,868 | RM 1,705 | RM 730

Cordless Hedge Trimmer
Pemangkas Tanaman Pagar Tanpa Kord
充电式篱笆修剪机



- Delivers 2,700 SPM for increased cutting speed

Standard Equipment: Blade Cover

- RME: 1x Rapid Charger, 2x 4.0Ah Battery
- RFE: 1x Rapid Charger, 2x 3.0Ah Battery
- Z: Without Charger & Battery



Blade Length Panjang bilah 刀片长度	520mm (20-1/2")
Strokes Per Minute (SPM) Kelajuan Strok 冲程速度	2,700
Tooth Spacing Selang Gigi 牙齿间隔	26mm (1")
Dimensions (L x W x H) Dimensi 体积	938x195x193mm (37"x7-5/8"x7-5/8")
Max Output Keluasan Maksima 最大输出	210W
Net Weight Berat Bersih 净重	3.0 - 3.4kg (6.7 - 7.5lbs)
Continuous Usage Time (approx.) Masa Penggunaan Berterusan 连续使用时间	130 min with BL1850B

* All list price shown are for reference only (exclude SST).

* Semua harga yang ditunjukkan adalah untuk rujukan sahaja (tidak termasuk SST). 所有显示的建议零售价仅供参考 (不包括SST)。

Cordless Impact Driver
LED Flashlight
Vacuum Cleaner
Drilling / Fastening
Impact Drilling / Demolition
Cutting
Grinding / Sanding
Sawing
Planing / Routing
Others
Outdoor Power Equipment





Cordless Hedge Trimmer

Pemangkas Tanaman Pagar Tanpa Kord 充电式篱笆修剪机

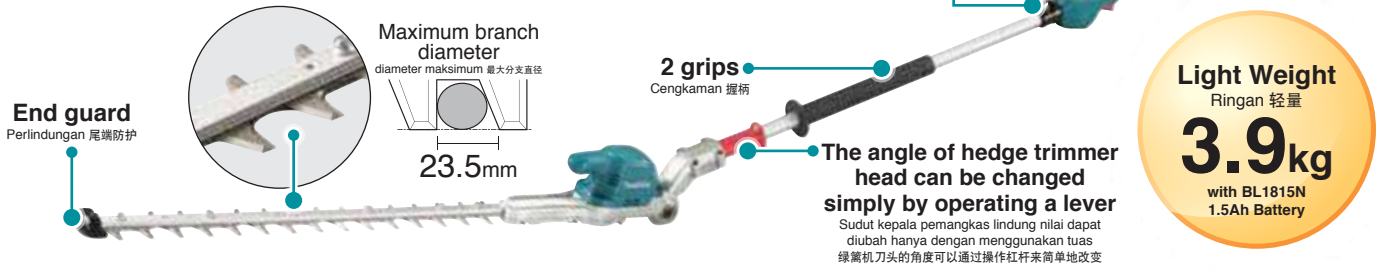

DUN500WZ 500mm (19-3/4")

Price TBA

Cordless Hedge Trimmer
Pemangkas Tanaman Pagar Tanpa Kord
充电式篱笆修剪机



- Lightweight for reduced operator fatigue

Standard Equipment: Blade Cover, Band Assembly
• Z: Without Charger & Battery



Blade Length Panjang bilah 刀片长度	500mm (19-3/4")
Strokes Per Minute (SPM) Kelajuan Strok 冲程速度	High: 4,400 Med: 3,600 Low: 2,000
Tooth Spacing Selang Gigi 牙齿间隔	35mm (1-3/8")
Max Cutting Capacity Kapasiti Pemotongan Maksimum 最大切割能力	23.5mm (15/16")
Dimensions (L x W x H) Dimensi 体积	2,115x97x137mm (83-1/4"x3-13/16"x5-3/8")
Net Weight Berat Bersih 净重	3.9 - 4.3kg (8.6 - 9.5lbs.)
Continuous Usage Time (approx.) Masa Penggunaan Berterusan 连续使用时间	High: 50min Med: 75min Low: 150min with BL1850B

DUN600LZ 600mm (23-5/8")

Price TBA

Cordless Hedge Trimmer
Pemangkas Tanaman Pagar Tanpa Kord
充电式篱笆修剪机



- Lightweight for reduced operator fatigue

Standard Equipment: Blade Cover, Hex Wrench
• Z: Without Charger & Battery



Blade Length Panjang bilah 刀片长度	600mm (23-5/8")
Strokes Per Minute (SPM) Kelajuan Strok 冲程速度	High: 4,400 Med: 3,600 Low: 2,000
Tooth Spacing Selang Gigi 牙齿间隔	35mm (1-3/8")
Max Cutting Capacity Kapasiti Pemotongan Maksimum 最大切割能力	23.5mm (15/16")
Dimensions (L x W x H) Dimensi 体积	2,050x230x178mm (80-1/2"x9"x7")
Net Weight Berat Bersih 净重	3.7 - 4.1kg (8.2 - 9.0lbs.)
Continuous Usage Time (approx.) Masa Penggunaan Berterusan 连续使用时间	High: 45min Med: 66min Low: 150min with BL1850B

DUR190LRT2

Price TBA

Cordless Grass Trimmer
Pemotong Rumput Tanpa Kord
充电式割草机



- lightweight and powerful cutting performance

Standard Equipment: Plastic Blade, Safety Goggles, Band Assembly, Accessory Bag, Hex Wrench
• RT2: 1x Rapid Charger, 2x 5.0Ah Battery



Cutting Width Lebar Keratan 切割宽度	Trimmer Head: 300mm (11-3/4") Metal Blade: 230mm (9") Plastic Blade: 255mm (10")
No Load Speed (RPM) Kelajuan Tanpa Beban 回转数	3,500 - 6,000
Spindle Size Saiz Spinde 主轴尺寸	M10 x 1.25LH
Dimensions (L x W x H) Dimensi 体积	1,836x348x236mm (72-1/4"x13-3/4"x9-1/4")
Net Weight Berat Bersih 净重	2.9 - 3.2kg (6.4 - 7.1lbs.)

DUR189Z

RM 1,127

Cordless Grass Trimmer
Pemotong Rumput Tanpa Kord
充电式割草机

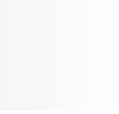

- Comfortable short telescopic pipe provides easy handling in tight spaces

Standard Equipment: Band Assembly, Nylon Cutting Head, Accessory Bag, Hex Wrench
• Z: Without Charger & Battery



Cutting Width Lebar Keratan 切割宽度	Trimmer Head: 300mm (11-3/4") Plastic Blade: 255mm (10")
No Load Speed (RPM) Kelajuan Tanpa Beban 回转数	High: 6,000 Medium: 5,000 Low: 4,000 ADT: 4,000 - 6,000
Spindle Size Saiz Spinde 主轴尺寸	M8 x 1.25RH
Dimensions (L x W x H) Dimensi 体积	1,518-1,618x258x369mm (59-3/4" - 63-3/4"x10-1/8"x14-1/2")
Net Weight Berat Bersih 净重	3.1 - 3.4kg (6.8 - 7.5lbs.)
Continuous Usage Time (approx.) Masa Penggunaan Berterusan 连续使用时间	Low - 181min Mid - 121min High - 102min with BL1850B

* All list price shown are for reference only (exclude SST).

* Semua harga yang ditunjukkan adalah untuk rujukan sahaja (tidak termasuk SST). 所有显示的建议零售价仅供参考 (不包括SST)。



18V

LXT

Li-ion Ah 6.0 | 5.0 | 4.0 | 3.0 | 2.0 | 1.5

DUR188LRF | DUR188LZ

RM 2,282

RM 1,305

Cordless Grass Trimmer
Pemotong Rumput Tanpa Kord
充电式割草機

Split shaft

for easily carried & store in car boot
Batang terasing mudah dimasukkan dalam kereta
可拆分的把手方便放入车箱

- Plastic triple blade for heavy duty operation

Standard Equipment: Band Assembly, Nylon Cutting Head, Accessory Bag, Hex Wrench

- RFE: 1x Rapid Charger, 2x 3.0Ah Battery
- Z: Without Charger & Battery



DUR187/188

VIDEO CLIP
Models and specs may vary by country

Cutting Width Lebar Keratan 切割宽度	Nylon Cutting Head: 300mm (11-3/4") Plastic Blade: 255mm (10")
No Load Speed (RPM) Kelajuan Tanpa Beban 回转速数	High: 6,000 Medium: 5,000 Low: 4,000 ADT: 4,000 - 6,000
Spindle Size Saiz Spindel 主轴尺寸	M8 x 1.25 LH
Dimensions (L x W x H) Dimensi 体积	1,791x258x232mm (70-1/2"x10-1/8"x9-1/8")
Net Weight Berat Bersih 淨重	3.7 - 4.0kg (8.1 - 8.8lbs)
Continuous Usage Time (approx.) Masa Penggunaan Berterusan 连续使用时间	115 min With BL1860B, Plastic Blade (Low Speed) 124 min With BL1860B, Nylon Cutting Head (Low Speed)

DUR188URFE

RM 2,275

Cordless Grass Trimmer
Pemotong Rumput Tanpa Kord
充电式割草機

Split shaft

for easily carried & store in car boot
Batang terasing mudah dimasukkan dalam kereta
可拆分的把手方便放入车箱

- Plastic triple blade for heavy duty operation

Standard Equipment: Band Assembly, Nylon Cutting Head, Accessory Bag, Hex Wrench

- RFE: 1x Rapid Charger, 2x 3.0Ah Battery



Cutting Width Lebar Keratan 切割宽度	Nylon Cutting Head: 300mm (11-3/4") Plastic Blade: 255mm (10")
No Load Speed (RPM) Kelajuan Tanpa Beban 回转速数	High: 6,000 Medium: 5,000 Low: 4,000 ADT: 4,000 - 6,000
Spindle Size Saiz Spindel 主轴尺寸	M8 x 1.25 LH
Dimensions (L x W x H) Dimensi 体积	1,791x600x472mm (70-1/2"x23-5/8"x18-5/8")
Net Weight Berat Bersih 淨重	3.5 - 3.8kg (7.7 - 8.3lbs)
Continuous Usage Time (approx.) Masa Penggunaan Berterusan 连续使用时间	115 min With BL1860B, Plastic Blade (Low Speed) 124 min With BL1860B, Nylon Cutting Head (Low Speed)

DUR187LRF | DUR187LZ

RM 2,052

RM 1,075

Cordless Grass Trimmer
Pemotong Rumput Tanpa Kord
充电式割草機



- 4 Mode rotation selection: 3 stages + ADT mode

Standard Equipment: Band Assembly, Nylon Cutting Head, Accessory Bag, Hex Wrench

- RFE: 1x Rapid Charger, 2x 3.0Ah Battery
- Z: Without Charger & Battery



DUR187/188

VIDEO CLIP
Models and specs may vary by country

Cutting Width Lebar Keratan 切割宽度	Nylon Cutting Head: 300mm (11-3/4") Plastic Blade: 255mm (10")
No Load Speed (RPM) Kelajuan Tanpa Beban 回转速数	High: 6,000 Medium: 5,000 Low: 4,000 ADT: 4,000 - 6,000
Spindle Size Saiz Spindel 主轴尺寸	M8 x 1.25 LH
Dimensions (L x W x H) Dimensi 体积	1,791x258x232mm (70-1/2"x10-1/8"x9-1/8")
Net Weight Berat Bersih 淨重	3.4 - 3.7kg (7.5 - 8.2lbs)
Continuous Usage Time (approx.) Masa Penggunaan Berterusan 连续使用时间	Low - 181min Mid - 121min High - 102min with BL1850B

DUR184LZ

RM 1,400

Cordless Grass Trimmer
Pemotong Rumput Tanpa Kord
充电式割草機



- Low noise level for improved user comfort

Standard Equipment: Safety Goggles, Band Assembly, Nylon Cutting Head, Accessory Bag, Hex Wrench

- Z: Without Charger & Battery



Cutting Width Lebar Keratan 切割宽度	Trimmer Head: 300mm (11-3/4")
Spindle Size Saiz Spindel 主轴尺寸	M8 x 1.25RH
Max Output Keluasan Maksima 最大输出	250W
No Load Speed (RPM) Kelajuan Tanpa Beban 回转速数	High: 6,000 Low: 5,000
Dimensions (L x W x H) Dimensi 体积	1,534-1,634x258x417mm (60-1/2" - 64-1/2"x10-1/8"x16-3/8")
Net Weight Berat Bersih 淨重	3.1 - 3.4kg (6.8 - 7.5lbs)
Continuous Usage Time (approx.) Masa Penggunaan Berterusan 连续使用时间	80 min With BL1850B

DUR182LRF | DUR182LZ

RM 2,203

RM 1,548

Cordless Grass Trimmer
Pemotong Rumput Tanpa Kord
充电式割草機



- BL motor for faster cutting

Standard Equipment: Safety Goggles, Band Assembly, Nylon Cutting Head, Accessory Bag, Hex Wrench

- RF: 1x Rapid Charger, 1x 3.0Ah Battery
- Z: Without Charger & Battery



Cutting Width Lebar Keratan 切割宽度	Trimmer Head: 300mm (11-3/4") Metal Blade: 230mm (9")
No Load Speed (RPM) Kelajuan Tanpa Beban 回转速数	3,500 - 6,000
Spindle Size Saiz Spindel 主轴尺寸	M8 x 1.25 LH
Dimensions (L x W x H) Dimensi 体积	1,843x287x253mm (72-1/2"x11-1/4"x10")
Net Weight Berat Bersih 淨重	3.6kg (8.0lbs)
Continuous Usage Time (approx.) Masa Penggunaan Berterusan 连续使用时间	90 min With BL1830B

* All list price shown are for reference only (exclude SST).

* Semua harga yang ditunjukkan adalah untuk rujukan sahaja (tidak termasuk SST). 所有显示的建议零售价仅供参考 (不包括SST)。



Li-ion Ah 6.0 5.0 4.0 3.0 2.0 1.5

DUR181Z

RM 632

Cordless String Trimmer
Pemotong Rumput Tanpa Kord
充电式割草机



- Lightweight for reduced operator fatigue

Standard Equipment: Safety Goggles, Band Assembly, Nylon Cutting Head, Nylon Cord

• Z: Without Charger & Battery



Cutting Width Lebar Keratan 切割宽度	Trimmer Head: 260mm (10-1/4")
No Load Speed (RPM) Kelajuan Tanpa Beban 回转数	7,800
Dimensions (L x W x H) Dimensi 体积	1,229 - 1,433x267x186 - 257mm (48-1/2 - 56-1/2"x10-1/2"x7-3/8 - 10-1/8")
Net Weight Berat Bersih 净重	2.8 - 3.1kg (6.2 - 6.9lbs.)
Continuous Usage Time (approx.) Masa Penggunaan Berterusan 连续使用时间	75 min with BL1850B

DUM604Z 160mm (6-5/16")

RM 632

Cordless Grass Shear
Pemotong Rumput Tanpa Kord
充电式割草机



- 2 in 1: trimmer and shear blade can be attached

Standard Equipment: Grass Receiver, Blade Cover

• Z: Without Charger & Battery



Cutting Width Lebar Keratan 切割宽度	160mm (6-5/16")
Depth Adjustment Pelarasan Kedalaman 深度调整	15mm (9/16") 20mm (13/16") 25mm (1")
Strokes Per Minute (SPM) Kelajuan Strok 冲程速度	2,500
Dimensions (L x W x H) Dimensi 体积	337x177x131mm (13-1/4"x7"x5-1/8")
Net Weight Berat Bersih 净重	1.4 - 1.8kg (3.2 - 4.0 lbs)
Continuous Usage Time (approx.) Masa Penggunaan Berterusan 连续使用时间	200 min with BL1850B

DUM168Z 160mm (6-5/16")

RM 638

Cordless Grass Shear
Pemotong Rumput Tanpa Kord
充电式割草机



- 2 in 1: trimmer and shear blade can be attached

Standard Equipment: Base Frame, Blade Cover

• Z: Without Charger & Battery



Cutting Width Lebar Keratan 切割宽度	160mm (6-5/16")
Depth Adjustment Pelarasan Kedalaman 深度调整	10mm (3/8") 20mm (13/16") 30mm (1 - 3/16")
Strokes Per Minute (SPM) Kelajuan Strok 冲程速度	2,500
Dimensions (L x W x H) Dimensi 体积	353x176x130mm (13-7/8"x6-15/16"x5-1/8")
Net Weight Berat Bersih 净重	1.4kg (3.0lbs.)
Continuous Usage Time (approx.) Masa Penggunaan Berterusan 连续使用时间	220 min with BL1850B

DUC254Z 250mm (10")

RM 1,698

Cordless Chain Saw
Gergaji Rantai Tanpa Kord
充电式链锯



- High Cutting Performance, Ultra Lightweight Top Handle Chain Saw

Standard Equipment: Saw Chain, Guide Bar, Guide Bar Cover

• Z: Without Charger & Battery



Guide Bar Length Panjang Batang Gergaji 切割长度	250mm (10")
Chain Pitch Kerapatan Rantai 链条齿距	3/8"
Chain Gauge Ketebalan Rantai 链条厚度	1.1mm (0.043")
Chain Speed Kelajuan Rantai 链条速度	0 - 24m/s (0 - 1,440m/min) (0 - 4,720FPM)
Chain Oil Tank Volume Tangki Minyak Pelincir 链油箱	140mL
Dimensions (L x W x H) Dimensi 体积	256x185x190mm (10-1/8"x7-1/2"x7-1/4")
Net Weight Keberatan 净重	2.8 - 3.3kg (6.3 - 7.3lbs)
Work Amount (approx.) Jumlah Kerja 工作量	160 cuts BL1850B (50mm Timber)

DUC122RME | **DUC122Z** 115mm (4-1/2")

RM 2,670

RM 1,532

430

Cordless Chain Saw
Gergaji Rantai Tanpa Kord
充电式链锯



- Low noise & zero emissions for operator comfort

Standard Equipment: Saw Chain, Guide Bar, Guide Bar Cover, Chain Oil, File

- RME: 1x Rapid Charger, 2x 4.0Ah Battery
- Z: Without Charger, Battery & Carrying Case



Guide Bar Length Panjang Batang Gergaji 切割长度	115mm (4-1/2")
Chain Pitch Kerapatan Rantai 链条齿距	1/4"
Chain Gauge Ketebalan Rantai 链条厚度	1.3mm (0.05")
Chain Speed Kelajuan Rantai 链条速度	5.0m/s (300m/min) (980FPM)
Chain Oil Tank Volume Tangki Minyak Pelincir 链油箱	80mL (2.7 US oz)
Dimensions (L x W x H) Dimensi 体积	422x195x215mm (16-5/8"x7-5/8"x8-1/2")
Net Weight Keberatan 净重	2.6kg (5.7lbs)
Work Amount (approx.) Jumlah Kerja 工作量	320 cuts BL1850B (50mm Timber)

* All list price shown are for reference only (exclude SST).

* Semua harga yang ditunjukkan adalah untuk rujukan sahaja (tidak termasuk SST). 所有显示的建议零售价仅供参考 (不包括SST)。

Cordless
Tangle-free Blade

LED Flashlight
Lampu Cahaya LED
LED照明灯

Vacuum Cleaner
Penyedut Vakuum
吸尘器

Drilling / Fastening
Gergaji / Pengikat
钻孔 / 紧固

Impact Drilling / Demolition
Gergaji / Pemusnah
冲击钻孔 / 拆除

Cutting
Pemotong
切割

Grinding / Sanding
Pergasi / Pasir
磨削 / 打磨

Sawing
Gergaji
锯切

Planing / Routing
Pegayaan / Tangan
刨平 / 雕刻

Others
Lain-lain
其他

Outdoor Power Equipment
Alatan Kerja Luar
户外动力设备



18V **LXT** **Li-ion** Ah 6.0 | 5.0 | 4.0 | 3.0 | 2.0 | 1.5

Cordless Blower

Mesin Peniup Tanpa Kord 充电式吹风机

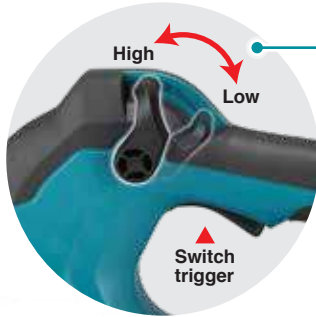

Light weight
Ringan 轻量
3.0kg
with BL1850B
5.0Ah Battery



Max Air Velocity
Velositi Angin Maksimum
最大风速
52.1 m/s

Max Air Volume
Isipadu Angin Maksimum
最大风量
13.0 m³/min

Hole on the bottom of housing for hanging the machine

Lubang di bahagian bawah casing digunakan untuk menggantung mesin
机壳底部的孔用于悬挂机器

DUB184RT | **DUB184Z**
RM 2,005 | RM 1,193

Cordless Blower
Mesin Peniup Tanpa Kord
充电式吹风机



- Compact and lightweight for single handed operation

Standard Equipment: Nozzle, Hex Wrench

- RT: 1x Rapid Charger, 1x 5.0Ah Battery
- Z: Without Charger & Battery



Max Air Volume Isipadu Angin Maksimum 最大风量	13.0m³/min (459CFM)
Max Air Velocity Velositi Angin Maksimum 最大风速	52.1m/s (116MPH)
No Load Speed (RPM) Kelajuan Tanpa Beban 回转数	0 - 18,000
Dimensions (L x W x H) Dimensi 体积	825x160x285mm (32-1/2"x6-5/16"x11-1/4")
Net Weight Berat Bersih 净重	2.5 - 3.0kg (5.4 - 6.7lbs.)

DUB183Z
RM 500

Cordless Blower
Mesin Peniup Tanpa Kord
充电式吹风机



- Long blowing nozzle with curved tip for optimal blowing performance

Standard Equipment: Garden Nozzle

- Z: Without Charger & Battery



Air Volume Isipadu Angin 风量	2.6m³/min
Air Speed Kelajuan Angin 风速	52m/s
No Load Speed (RPM) Kelajuan Tanpa Beban 回转数	0-18,000
Dimensions (L x W x H) Dimensi 体积	845x155x212mm (33-1/4"x6-1/8"x8-3/8")
Net Weight Berat Bersih 净重	1.7kg (3.8lbs)
Continuous Usage Time (approx.) Masa Penggunaan Berterusan 连续使用时间	Low - 129 min Mid - 43 min High - 18 min with BL1850B

DUB182Z
RM 382

Cordless Blower
Mesin Peniup Tanpa Kord
充电式吹风机



- Compact and ergonomic design at only 525mm (20-3/4") long

Standard Equipment: Nozzle assembly

- Z: Without Charger & Battery



Air Volume Isipadu Angin 风量	2.6m³/min
Air Speed Kelajuan Angin 风速	80m/s
Air Pressure Udara Tekanan 气压	5.4kPa (550mmH ₂ O)
No Load Speed (RPM) Kelajuan Tanpa Beban 回转数	0-18,000
Dimensions (L x W x H) Dimensi 体积	525x155x212mm (20-3/4"x6-1/8"x8-3/8")
Net Weight Berat Bersih 净重	1.7kg (3.7lbs)
Continuous Usage Time (approx.) Masa Penggunaan Berterusan 连续使用时间	20 min with BL1850B

* All list price shown are for reference only (exclude SST).

* Semua harga yang ditunjukkan adalah untuk rujukan sahaja (tidak termasuk SST). 所有显示的建议零售价仅供参考 (不包括SST)。

Cordless Impact Driver
LED Flashlight
Vacuum Cleaner
Drilling / Fastening
Impact Drilling / Demolition
Cutting
Grinding / Sanding
Sawing
Planing / Routing
Others
Outdoor Power Equipment





Li-ion Ah 6.0 5.0 4.0 3.0 2.0 1.5

DCU180Z

RM 5,740

Battery Powered Wheelbarrow

Kereta Sorong Berkuasa Bateri
充电式搬运车



- Ideal for use at urban construction sites and on farms



VIDEO CLIP
Models and specs may vary by country



Standard Equipment:
Lock Key, Support Legs, Wrenches

- Z: Without Charger & Battery



Max Load Capacity Kapasiti Berat Maksimum 最大重量	130kg (290lbs.)
Traveling Speed Kelajuan Perjalanan 行驶速度	Forward High: 0 - 3.5km/h Forward Low: 0 - 1.5km/h Reverse: 0 - 1 km/h
Max Climbing Capacity Pergerakan atas Kecerunan Maksimum 最大爬坡能力	12°
Dimensions (L x W x H) Dimensi 体积	When carrier is installed/ During operation: 1,315x1,060x900mm (51-3/4"x41-3/4"x35-1/2") When carrier is installed/ When stored: 1,110x820x820mm (43-3/4"x32-1/4"x32-1/4") When bucket is installed/ During operation: 1,310x820x900 mm (51-1/2"x32-1/4"x35-1/2") When bucket is installed/ When stored: 1,110x820x820mm (43-3/4"x32-1/4"x32-1/4")
Net Weight Keberatan 净重	39.3 - 44.8kg (86.5 - 98.7lbs)
Continuous Usage Time (approx.) Masa Penggunaan Berterusan 连续使用时间	100 min with BL1850B x2

DVF154Z 15L

RM 3,008

Cordless Garden Sprayer

Penyembur Tanaman Tanpa Kord
充电式花园喷雾器



- Reduced running cost with Li-ion battery



Standard Equipment: Upright Double-Headed Nozzle, Wide-Angle Herbicide Nozzle, Spray Pipe Holder, Shoulder Harness

- Z: Without Charger & Battery

Max Pressure Tekanan Maksimum 最大水压	0.3MPa (3 kgf/cm ²)
Chemical Tank Tangki Kimia 化学箱容量	15L
Dimensions (L x W x H) Dimensi 体积	345x235x525mm (13-5/8"x9-1/4"x20-3/4")
Net Weight Berat Bersih 净重	4.1 - 4.4kg (9.1 - 9.7lbs)
Continuous Usage Time (approx.) Masa Penggunaan Berterusan 连续使用时间	Wide Angle Nozzle 344 min Double Nozzle 215 min with BL1850B

DVR450Z 1,200mm (4.0ft)

RM 1,538

Cordless Concrete Vibrator

Penggetar Konkrit Tanpa Kord
充电式混凝土振动器



- Makita-built motor delivers 13,000VPM to help increase strength of concrete



- Z: Without Charger & Battery

Diameter of Vibrator Diameter Penggetar 振动器的直径	25mm (1")
Flexible Shaft Assembly Length Kelajuan Pemasangan Fleksibel 柔性轴组件长度	1,200mm (4.0 ft)
Vibrations Per Minute (VPM) Getaran Setiap Minit 每分钟振动	13,000
Dimensions (L x W x H) Dimensi 体积	1,483x93x250mm (58-1/2"x3-5/8"x9-7/8")
Net Weight Berat Bersih 净重	3.3 - 3.8kg (7.3 - 8.3lbs)
Continuous Usage Time (approx.) Masa Penggunaan Berterusan 连续使用时间	41 min with BL1850B

DCG180RFE

RM 2,347

DCG180RFE B

RM 2,398

DCG180ZB

RM 1,423

DCG180Z

RM 1,372

Cordless Caulking Gun

Pistol Caulking Tanpa Kord
充电式填缝枪



VIDEO CLIP
Models and specs may vary by country

- 5 Speed dial optimizes flow rate 0 - 28mm/sec

Standard Equipment:

RFE / Z: 300mL Holder A, Holder Joint A, Piston, Rack 42, Safety Goggles
RFE B / ZB: 600mL Holder B, Holder Joint B, Piston, Nozzle, Rubber Ring, Rack 64, Safety Goggles

- RFE: 1x Rapid Charger, 2x 3.0Ah Battery
- RFE B: 1x Rapid Charger, 2x 3.0Ah Battery
- ZB: Without Charger, Battery & Carrying Case
- Z: Without Charger, Battery & Carrying Case

*Not applicable for Z & ZB model

Max Dispersing Force Tujahan Maksimum 最大推力	5,000N (1,100lbs)
No Load Speed Kelajuan Tanpa Beban 回转数	0 - 28mm/sec. (0 - 66in/min.)
Holder Size Kapasiti 容量	300mL 600mL (Optional Accessories 800mL Holder)
Dimensions (L x W x H) Dimensi 体积	404x108x281mm (15-7/8"x4-1/4"x11-1/8")
Net Weight Berat Bersih 净重	2.1 - 3.0kg (4.7 - 6.6lbs)
Work Amount (approx.) Jumlah Kerja 工作量	500 pcs with BL1830B 300ml silicon sealant

DMP180Z

RM 585

Cordless Inflator

Inflator Tanpa Kord
充电式打气机



- Inflates the Tires of Cars, Bikes, Sport Balls, etc

Standard Equipment: British Adapter, French Adapter, Ball Adapter, Swim Ring Adapter

- Z: Without Charger & Battery



Max Air Pressure Udara Tekanan Maksimum 最大气压	830kPa (121 PSI) [8.3 bar]
Air Discharge Amount Pelepasan Udara 空气排放量	200kPa: 12L/min 700kPa: 8L/min 830kPa: 7L/min
Hose Length Panjang Hos 软管长度	65cm (25-1/2")
Dimensions (L x W x H) Dimensi 体积	246x80x174mm (9-11/16"x3-1/8"x6-7/8")
Net Weight Berat Bersih 净重	1.4 - 1.7kg (3.1 - 3.8lbs.)
Work Amount (approx.) Jumlah Kerja 工作量	9 tires with BL1850B (16" Car Tires 215/60R16)

* All list price shown are for reference only (exclude SST).

* Semua harga yang ditunjukkan adalah untuk rujukan sahaja (tidak termasuk SST). 所有显示的建议零售价仅供参考 (不包括SST)。

Cordless
Tanpa Kord / Cordless

LED Flashlight
Lampu Sinar LED
LED照明灯

Vacuum Cleaner
Penyedut Vakuum
吸尘器

Drilling / Fastening
Guaian / Pasang
钻孔 / 紧固

Impact Drilling / Demolition
Guaian / Pasang
冲击钻孔 / 拆除

Cutting
Pemotong
切割

Grinding / Sanding
Pengisar / Pasah
打磨 / 磨光

Sawing
Guaian
锯切

Planing / Routing
Penghalus / Tangkapan
刨平 / 铣削

Others
Lain-lain
其他

Outdoor Power Equipment
Alatan Kerja Luar
户外动力设备

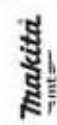



DF332DSME RM 1,510 | **DF332DSAE** RM 1,328 | **DF332DZ** 10mm (3/8") RM 680

Cordless Driver Drill
Gerudi Pemutar Skru Tanpa Kord
充电式螺丝起子电钻

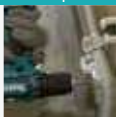

- BL motor with high power

Standard Equipment: Phillips Bit, Belt Clip

- SME: 1x Speed Charger, 2x 4.0Ah Battery
- SAE: 1x Speed Charger, 2x 2.0Ah Battery
- Z: Without Charger, Battery & Carrying Case



Capacity Kapasiti 能力	Steel: 10 (3/8") Wood: 28mm (1-1/8")
Chuck Capacity Kapasiti Chuck 夹头能力	0.8 - 10mm (1/32 - 3/8")
No Load Speed (RPM) Kelajuan Tanpa Beban 回转数	High: 0 - 1,500 Low: 0 - 450
Max Fastening Torque Maksimum Tenaga Pemutaran Pengancing 最快扭力	Hard: 35N-m (310in.lbs.) Soft: 21N-m (190in.lbs.)
Max Lock Torque Pemutaran Tenaga Maksimum 最大扭力	32N-m (280in.lbs.)
Dimensions (L x W x H) Dimensi 体积	154x66x217mm (6-1/16"x2-5/8"x8-1/2")
Net Weight Berat Bersih 净重	1.0 - 1.2kg (2.3 - 2.6lbs)
Work Amount (approx.) Jumlah Kerja 工作量	460 holes with BL1021B Drilling ø9mm Auger Bit, Melapi 30mm Thickness

DF333DSME RM 1,160 | **DF333DWA** RM 895 | **DF333DZ** 10mm (3/8") RM 330

Cordless Driver Drill
Gerudi Pemutar Skru Tanpa Kord
充电式螺丝起子电钻



- Increased motor power for higher speed and max tightening torque

Standard Equipment: Phillips Bit, Belt Clip

- SME: 1x Speed Charger, 2x 4.0Ah Battery
- WAE: 1x Standard Charger, 2x 2.0Ah Battery
- Z: Without Charger, Battery & Carrying Case



Capacity Kapasiti 能力	Steel: 10mm (3/8") Wood: 21mm (13/16")
Chuck Capacity Kapasiti Chuck 夹头能力	0.8 - 10mm (1/32 - 3/8")
No Load Speed (RPM) Kelajuan Tanpa Beban 回转数	High: 0 - 1,700 Low: 0 - 450
Max Fastening Torque Maksimum Tenaga Pemutaran Pengancing 最快扭力	Hard: 30N-m (270in.lbs.) Soft: 14N-m (130in.lbs.)
Max Lock Torque Pemutaran Tenaga Maksimum 最大扭力	28N-m (250in.lbs.)
Dimensions (L x W x H) Dimensi 体积	179x66x212mm (7"x2-5/8"x8-3/8")
Net Weight Berat Bersih 净重	1.1 - 1.2kg (2.4 - 2.7lbs.)

DF331DSME RM 1,160 | **DF331DZ** 10mm (3/8") RM 330

Cordless Driver Drill
Gerudi Pemutar Skru Tanpa Kord
充电式螺丝起子电钻

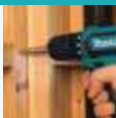

- Increased motor power for higher speed

Standard Equipment: Phillips Bit, Belt Clip

- SME: 1x Speed Charger, 2x 4.0Ah Battery
- Z: Without Charger, Battery & Carrying Case

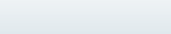

Capacity Kapasiti 能力	Steel: 10mm (3/8") Wood: 21mm (13/16")
Chuck Capacity Kapasiti Chuck 夹头能力	0.8 - 10mm (1/32 - 3/8")
No Load Speed (RPM) Kelajuan Tanpa Beban 回转数	High: 0 - 1,700 Low: 0 - 450
Max Fastening Torque Maksimum Tenaga Pemutaran Pengancing 最快扭力	Hard: 30N-m (270in.lbs.) Soft: 14N-m (130in.lbs.)
Max Lock Torque Pemutaran Tenaga Maksimum 最大扭力	28N-m (250in.lbs.)
Dimensions (L x W x H) Dimensi 体积	189x66x209mm (7-7/16"x2-5/8"x8-1/4")
Net Weight Berat Bersih 净重	1.1 - 1.3kg (2.4 - 2.8lbs)
Work Amount (approx.) Jumlah Kerja 工作量	350 holes with BL1021B Drilling ø9mm Auger Bit, Melapi 30mm Thickness

DF032DSME RM 1,488 | **DF032DSAE** RM 1,305 | **DF032DZ** 10mm (3/8") RM 658

Cordless Driver Drill
Gerudi Pemutar Skru Tanpa Kord
充电式螺丝起子电钻



- BL motor with high power

Standard Equipment: Phillips Bit, Belt Clip

- SME: 1x Speed Charger, 2x 4.0Ah Battery
- SAE: 1x Speed Charger, 2x 2.0Ah Battery
- Z: Without Charger, Battery & Carrying Case



Capacity Kapasiti 能力	Steel: 10mm (3/8") Wood: 28mm (1-1/8")
Chuck Capacity Kapasiti Chuck 夹头能力	6.35mm (1/4")
No Load Speed (RPM) Kelajuan Tanpa Beban 回转数	High: 0 - 1,500 Low: 0 - 450
Max Fastening Torque Maksimum Tenaga Pemutaran Pengancing 最快扭力	Hard: 35N-m (310in.lbs.) Soft: 21N-m (190in.lbs.)
Max Lock Torque Pemutaran Tenaga Maksimum 最大扭力	32N-m (280in.lbs.)
Dimensions (L x W x H) Dimensi 体积	124x66x217mm (4-7/8"x2-5/8"x8-1/2")
Net Weight Berat Bersih 净重	0.88 - 1kg (1.9 - 2.3lbs)
Work Amount (approx.) Jumlah Kerja 工作量	200 holes with BL1021B Wood Drilling ø3x1.6mm

DF033DSME RM 1,127 | **DF033DWA** RM 862 | **DF033DZ** 10mm (3/8") RM 298

Cordless Driver Drill
Gerudi Pemutar Skru Tanpa Kord
充电式螺丝起子电钻



- Increased motor power for higher speed and max tightening torque

Standard Equipment: Phillips Bit, Belt Clip

- SME: 1x Speed Charger, 2x 4.0Ah Battery
- WAE: 1x Standard Charger, 2x 2.0Ah Battery
- Z: Without Charger, Battery & Carrying Case



Capacity Kapasiti 能力	Steel: 10mm (3/8") Wood: 21mm (13/16")
Chuck Capacity Kapasiti Chuck 夹头能力	6.35mm (1/4")
No Load Speed (RPM) Kelajuan Tanpa Beban 回转数	High: 0 - 1,700 Low: 0 - 450
Max Fastening Torque Maksimum Tenaga Pemutaran Pengancing 最快扭力	Hard: 30N-m (270in.lbs.) Soft: 14N-m (130in.lbs.)
Max Lock Torque Pemutaran Tenaga Maksimum 最大扭力	28N-m (250in.lbs.)
Dimensions (L x W x H) Dimensi 体积	149x66x212mm (5-7/8"x2-5/8"x8-3/8")
Net Weight Berat Bersih 净重	0.9 - 1.1kg (2.1 - 2.4lbs.)

* All list price shown are for reference only (exclude SST).

* Semua harga yang ditunjukkan adalah untuk rujukan sahaja (tidak termasuk SST). 所有显示的建议零售价仅供参考 (不包括SST)。

Cordless Impact Driver
LED Flashlight Lampu Suluh LED
Vacuum Cleaner
Drilling / Fastening
Impact Drilling / Demolition
Cutting
Grinding / Sanding
Sawing
Planing / Routing
Others
Outdoor Power Equipment



12V_{max}

CXT

Li-ion Ah 4.0 2.0 1.5

DF031DSME RM 1,127 | **DF031DWAE** RM 862 | **DF031DWYE** RM 807 | **DF031DZ** 10mm (3/8") RM 298

Cordless Driver Drill
Gerudi Pemutar Skru Tanpa Kord
充电式螺丝起子电钻



• Ideal for work in tight spaces

Standard Equipment: Phillips Bit, Belt Clip

- SME: 1x Speed Charger, 2x 4.0Ah Battery
- WAE: 1x Standard Charger, 2x 2.0Ah Battery
- WYE: 1x Standard Charger, 2x 1.5Ah Battery
- Z: Without Charger, Battery & Carrying Case



Capacity Kapasiti 能力	Steel: 10mm (3/8") Wood: 21mm (13/16") 6.35mm (1/4")
Hex Shank Batang Heksagon 六角柄	
No Load Speed (RPM) Kelajuan Tanpa Beban 回转数	High: 0 - 1,700 Low: 0 - 450
Max Fastening Torque Maksimum Tenaga Pemutaran Pengancing 最快扭力	Hard: 30N-m (270in.lbs.) Soft: 14N-m (130in.lbs.)
Max Lock Torque Pemutaran Tenaga Maksimum 最大扭矩	28N-m (250in.lbs.)
Dimensions (L x W x H) Dimensi 体积	157x66x209mm (6-3/16"x2-5/8"x8-1/4")
Net Weight Berat Bersih 淨重	0.94 - 1.1kg (2.1 - 2.5lbs)
Work Amount (approx.) Jumlah Kerja 工作量	160 holes with BL1021B Wood Drilling ø3x1.6mm

HP332DSME RM 1,577 | **HP332DSAE** RM 1,395 | **HP332DZ** 10mm (3/8") RM 748

Cordless Hammer Driver Drill
Tukul Pemutar Skru Bergerudi Tanpa Kord
充电式冲击螺丝起子电钻



• Fast hammer drilling in masonry materials

Standard Equipment: Phillips Bit, Belt Clip

- SME: 1x Speed Charger, 2x 4.0Ah Battery
- SAE: 1x Standard Charger, 2x 2.0Ah Battery
- Z: Without Charger, Battery & Carrying Case



Capacity Kapasiti 能力	Steel: 10mm (3/8") Wood: 28mm (1-1/8") Masonry: 8mm (5/16")
Chuck capacity Kapasiti Chuck 夹头能力	0.8 - 10mm (1/32 - 3/8")
Impacts Per Minute (IPM) Impak Per Minit 冲击数	High: 0 - 22,500 Low: 0 - 6,750
No Load Speed (RPM) Kelajuan Tanpa Beban 回转数	High: 0 - 1,500 Low: 0 - 450
Max Fastening Torque Maksimum Tenaga Pemutaran Pengancing 最快扭力	Hard: 35N-m (310in.lbs.) Soft: 21N-m (190in.lbs.)
Max Lock Torque Pemutaran Tenaga Maksimum 最大扭矩	32N-m (280in.lbs.)
Dimensions (L x W x H) Dimensi 体积	168x66x217mm (6-5/8"x2-5/8"x8-1/2")
Net Weight Berat Bersih 淨重	1.1 - 1.3kg (2.4 - 2.8lbs)
Work Amount (approx.) Jumlah Kerja 工作量	460 holes with BL1021B Drilling ø9mm Auger Bit, Melapi 30mm Thickness

HP333DSME RM 1,235 | **HP333DWAE** RM 972 | **HP333DZ** 10mm (3/8") RM 407

Cordless Hammer Driver Drill
Tukul Pemutar Skru Bergerudi Tanpa Kord
充电式冲击螺丝起子电钻



• Increased motor power for higher speed and max tightening torque

Standard Equipment: Phillips Bit, Belt Clip

- SME: 1x Speed Charger, 2x 4.0Ah Battery
- WAE: 1x Standard Charger, 2x 2.0Ah Battery
- Z: Without Charger, Battery & Carrying Case



Capacity Kapasiti 能力	Steel: 10mm (3/8") Wood: 21mm (13/16") Masonry: 8mm (5/16")
Chuck Capacity Kapasiti Chuck 夹头能力	0.8 - 10mm (1/32 - 3/8")
Impacts Per Minute (IPM) Impak Per Minit 冲击数	High: 0 - 25,500 Low: 0 - 6,750
No Load Speed (RPM) Kelajuan Tanpa Beban 回转数	High: 0 - 1,700 Low: 0 - 450
Max Fastening Torque Maksimum Tenaga Pemutaran Pengancing 最快扭力	Hard: 30N-m (270in.lbs.) Soft: 14N-m (130in.lbs.)
Max Lock Torque Pemutaran Tenaga Maksimum 最大扭矩	28N-m (250 in.lbs.)
Dimensions (L x W x H) Dimensi 体积	193x66x212mm (7-5/8"x2-5/8"x8-3/8")
Net Weight Berat Bersih 淨重	1.1 - 1.3kg (2.4 - 2.9lbs.)

HP331DSME RM 1,235 | **HP331DWAE** RM 972 | **HP331DWYE** 10mm (3/8") RM 917

Cordless Hammer Driver Drill
Tukul Pemutar Skru Bergerudi Tanpa Kord
充电式冲击螺丝起子电钻



• High speed mode for speedy drilling

Standard Equipment: Phillips Bit, Belt Clip

- SME: 1x Speed Charger, 2x 4.0Ah Battery
- WAE: 1x Standard Charger, 2x 2.0Ah Battery
- WYE: 1x Standard Charger, 2x 1.5Ah Battery



Capacity Kapasiti 能力	Steel: 10mm (3/8") Wood: 21mm (13/16") Masonry: 8mm (5/16")
Impacts Per Minute (IPM) Impak Per Minit 冲击数	High: 0 - 25,500 Low: 0 - 6,750
No Load Speed (RPM) Kelajuan Tanpa Beban 回转数	High: 0 - 1,700 Low: 0 - 450
Max Fastening Torque Maksimum Tenaga Pemutaran Pengancing 最快扭力	Hard: 30N-m (270in.lbs.) Soft: 14N-m (130in.lbs.)
Max Lock Torque Pemutaran Tenaga Maksimum 最大扭矩	28N-m (250in.lbs.)
Dimensions (L x W x H) Dimensi 体积	201x66x209mm (7-7/8"x2-5/8"x8-1/4")
Net Weight Berat Bersih 淨重	1.1 - 1.3kg (2.5 - 2.9lbs)
Work Amount (approx.) Jumlah Kerja 工作量	350 holes with BL1021B Drilling ø9mm Auger Bit, Melapi 30mm Thickness

TD111DSME RM 1,510 | **TD111DWAE** RM 1,245 | **TD111DWYE** RM 1,190 | **TD111DZ** RM 680

Cordless Impact Driver
Pemutar Skru Impak Tanpa Kord
充电式冲击螺丝起子机

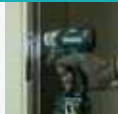

• 3-Mode operation: A-mode/ Hard mode/ Soft mode

Standard Equipment: Phillips Bit, Belt Clip

- SME: 1x Speed Charger, 2x 4.0Ah Battery
- WAE: 1x Standard Charger, 2x 2.0Ah Battery
- WYE: 1x Standard Charger, 2x 1.5Ah Battery
- Z: Without Charger, Battery & Carrying Case



Capacity Kapasiti 能力	Machine Screw: M4 - M8mm (5/32" - 5/16") Standard Bolt: M5 - M14 (3/16" - 9/16") High Tensile Bolt: M5 - M12 (3/16" - 1/2") Coarse thread (in length): 22 - 90mm (7/8" - 3-1/2")
Hex Shank Batang Heksagon 六角柄	6.35mm (1/4")
No Load Speed (RPM) Kelajuan Tanpa Beban 回转数	Hard: 0 - 3,000 Soft: 0 - 1,300
Impacts Per Minute (IPM) Impak Per Minit 冲击数	Hard: 0 - 3,900 Soft: 0 - 1,600
Max Fastening Torque Maksimum Tenaga Pemutaran Pengancing 最快扭力	135N-m (1,200in.lbs.)
Dimensions (L x W x H) Dimensi 体积	135x66x210mm (5-5/16"x2-5/8"x8-1/4")
Net Weight Berat Bersih 淨重	0.97 - 1.1kg (2.1 - 2.5lbs)
Work Amount (approx.) Jumlah Kerja 工作量	340 pcs with BL1021B Coarse Thread Wood Screw 45mm (Melapi)

* All list price shown are for reference only (exclude SST).

* Semua harga yang ditunjukkan adalah untuk rujukan sahaja (tidak termasuk SST). 所有显示的建议零售价仅供参考 (不包括SST)。

Cordless
Tangkas Tanpa Kord

LED Flashlight
Lampu Cahaya LED
LEDOBAT

Vacuum Cleaner
Penyedut Vakuum
VESIBET

Drilling / Fastening
Gerudi / Pengasing
METS / METS

Impact Drilling / Demolition
Gerudi / Penanggal
METS / METS

Cutting
Pemotong
METS

Grinding / Sanding
Pergasil / Habis
METS

Sawing
Gergaji
METS

Planing / Routing
Pegilatan / Tangkapan
METS

Others
Lain-lain
METS

Outdoor Power Equipment
Alatan Kerja Luar
METS

Makita
METS

12V_{max}

CXT

Li-ion Ah 4.0 2.0 1.5

TD110DSME RM 1,160 | **TD110DWAE** RM 895 | **TD110DWYE** RM 840 | **TD110DZ** RM 330

Cordless Impact Driver

Pemutar Skru Impak Tanpa Kord
充电式冲击螺丝起子机



- Compact and Lightweight

Standard Equipment: Phillips Bit, Belt Clip

- SME: 1x Speed Charger, 2x 4.0Ah Battery
- WAE: 1x Standard Charger, 2x 2.0Ah Battery
- WYE: 1x Standard Charger, 2x 1.5Ah Battery
- Z: Without Charger, Battery & Carrying Case

*Not applicable for Z model

Capacity Kapasiti 能力	Machine Screw: M4 - M8mm (5/32" - 5/16") Standard Bolt: M5 - M12 (3/16" - 1/2")
	High Tensile Bolt: M5 - M10 (3/16" - 3/8")
	Coarse thread (in length): 22 - 90mm (7/8" - 3-1/2")
	6.35mm (1/4")
Hex Shank Batang Heksagon 六角柄	
No Load Speed (RPM) Kelajuan Tanpa Beban 回转速数	0 - 2,600
Impacts Per Minute (IPM) Impak Per Minit 冲击数	0 - 3,500
Max Fastening Torque Maksimum Tenaga Pemutaran Pengancing 最快扭力	110N-m (970in.lbs.)
Dimensions (L x W x H) Dimensi 体积	153x66x204mm (6"x2-5/8"x8-1/8")
Net Weight Berat Bersih 淨重	1.0 - 1.2kg (2.3 - 2.6lbs)
Work Amount (approx.) Jumlah Kerja 工作量	250 pcs with BL1021B Coarse Thread Wood Screw 45mm (Melapi)

TW161DSME RM 1,422 | **TW161DWAE** RM 1,157 | **TW161DZ** 12.7mm (1/2") RM 593

Cordless Impact Wrench

Perengkuh Impak Tanpa Kord
充电式冲击套筒扳手



- Reverse Rotation Auto-Stop Mode stops in 0.2 seconds after loosened enough

Standard Equipment: Belt Clip

- SME: 1x Speed Charger, 2x 4.0Ah Battery
- WAE: 1x Standard Charger, 2x 2.0Ah Battery
- Z: Without Charger, Battery & Carrying Case

*Not applicable for Z model



Fastening Capacities Kapasiti 能力	Standard Bolt: M8 - M16 (5/16" - 5/8") High Tensile Bolt: M6 - M12 (1/4" - 1/2")
Square Drive Batang Segi Empat 四方头	12.7mm (1/2")
No Load Speed (RPM) Kelajuan Tanpa Beban 回转速数	Hard: 0 - 2,400 Soft: 0 - 1,300
Impacts Per Minute (IPM) Impak Per Minit 冲击数	Hard: 0 - 3,600 Soft: 0 - 2,000
Max Fastening Torque Maksimum Tenaga Pemutaran Pengancing 最快扭力	165N-m (122ft.lbs.)
Dimensions (L x W x H) Dimensi 体积	150x66x213mm (5-7/8"x2-5/8"x8-3/8")
Net Weight Berat Bersih 淨重	1.1 - 1.2kg (2.4 - 2.7lbs.)

TW160DZ 9.5mm (3/8") RM 593

Cordless Impact Wrench

Perengkuh Impak Tanpa Kord
充电式冲击套筒扳手



- 9.5mm (3/8") square drive fits most common automotive sockets

Standard Equipment: Belt Clip

- Z : Without Charger & Battery

*Not applicable for Z model



Fastening Capacities Kapasiti 能力	Standard Bolt: M8 - M16 (5/16" - 5/8") High Tensile Bolt: M6 - M12 (1/4" - 1/2")
Square Drive Batang Segi Empat 四方头	9.5mm (3/8")
No Load Speed (RPM) Kelajuan Tanpa Beban 回转速数	Hard: 0 - 2,400 Soft: 0 - 1,300
Impacts Per Minute (IPM) Impak Per Minit 冲击数	Hard: 0 - 3,600 Soft: 0 - 2,000
Max Fastening Torque Maksimum Tenaga Pemutaran Pengancing 最快扭力	160N-m (120ft.lbs.)
Dimensions (L x W x H) Dimensi 体积	144x66x213mm (5-5/8"x2-5/8"x8-3/8")
Net Weight Berat Bersih 淨重	1.0 - 1.2kg (2.2 - 2.6lbs.)

TW141DSME RM 1,202 | **TW141DWAE** RM 937 | **TW141DZ** 12.7mm (1/2") RM 372

Cordless Impact Wrench

Perengkuh Impak Tanpa Kord
充电式冲击套筒扳手



- Ultra compact design and lightweight

Standard Equipment: Belt Clip

- SME: 1x Speed Charger, 2x 4.0Ah Battery
- WAE: 1x Standard Charger, 2x 2.0Ah Battery
- Z: Without Charger, Battery & Carrying Case

*Not applicable for Z model

Fastening Capacities Kapasiti 能力	Standard Bolt: M8 - M16 (5/16" - 5/8") High Tensile Bolt: M6 - M12 (1/4" - 1/2")
Square Drive Batang Segi Empat 四方头	12.7mm (1/2")
No Load Speed (RPM) Kelajuan Tanpa Beban 回转速数	0 - 2,600
Impacts Per Minute (IPM) Impak Per Minit 冲击数	0 - 3,200
Max Fastening Torque Maksimum Tenaga Pemutaran Pengancing 最快扭力	145N-m (107ft.lbs.)
Dimensions (L x W x H) Dimensi 体积	168x66x205mm (6-5/8"x2-5/8"x8-1/8")
Net Weight Berat Bersih 淨重	1.1 - 1.2kg (2.4 - 2.7lbs.)

TW140DZ 9.5mm (3/8") RM 372

Cordless Impact Wrench

Perengkuh Impak Tanpa Kord
充电式冲击套筒扳手



- 9.5mm (3/8") square drive fits most common automotive sockets

Standard Equipment: Belt Clip

- Z : Without Charger & Battery

Fastening Capacities Kapasiti 能力	Standard Bolt: M8 - M16 (5/16" - 5/8") High Tensile Bolt: M6 - M12 (1/4" - 1/2")
Square Drive Batang Segi Empat 四方头	9.5mm (3/8")
No Load Speed (RPM) Kelajuan Tanpa Beban 回转速数	0 - 2,600
Impacts Per Minute (IPM) Impak Per Minit 冲击数	0 - 3,200
Max Fastening Torque Maksimum Tenaga Pemutaran Pengancing 最快扭力	140N-m (1,240in.lbs.)
Dimensions (L x W x H) Dimensi 体积	161x66x205mm (6-3/8"x2-5/8"x8-1/8")
Net Weight Berat Bersih 淨重	1 - 1.2kg (2.3 - 2.7lbs.)
Work Amount (approx.) Jumlah Kerja 工作量	160 pcs with BL1021B High Tensile Bolt M12 Standard Fastening Torque at 100N.m

* All list price shown are for reference only (exclude SST).

* Semua harga yang ditunjukkan adalah untuk rujukan sahaja (tidak termasuk SST). 所有显示的建议零售价仅供参考 (不包括SST)。

Cordless Impact Driver
LED Flashlight
Vacuum Cleaner
Drilling / Fastening
Impact Drilling / Demolition
Cutting
Grinding / Sanding
Sawing
Planing / Routing
Others
Outdoor Power Equipment



12V_{max}

CXT

Li-ion Ah 4.0 2.0 1.5

TW060DZ 6.35mm (1/4")
RM 372

Cordless Impact Wrench
Perengkuh Impak Tanpa Kord
充电式冲击套筒扳手

- Electric brake for increased operator safety



Standard Equipment: Belt Clip

- Z: Without Charger & Battery



Fastening Capacities Kapasiti 能力	Standard Bolt: M8 - M12 (5/16" - 15/32") High Tensile Bolt: M6 - M10 (1/4" - 3/8")
Square Drive Batang Segi Empat 四方头	6.35mm (1/4")
No Load Speed (RPM) Kelajuan Tanpa Beban 回转速	0 - 2,600
Impacts Per Minute (IPM) Impak Per Minit 冲击数	0 - 3,200
Max Fastening Torque Maksimum Tenaga Pemutaran Pengancing 最快扭力	60N-m (530in.lbs.)
Dimensions (L x W x H) Dimensi 体积	161x66x205mm (6-3/8"x2-5/8"x8-1/8")
Net Weight Berat Bersih 淨重	1.0 - 1.2kg (2.2 - 2.6lbs.)

Cordless Ratchet Wrench

Perengkuh Ratchet Tanpa Kord 充电式棘轮扳手

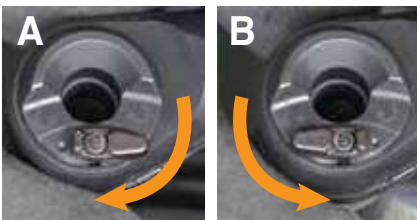

Max Fastening Torque
Tenaga Pemutaran Pengancing Maksimum 最快扭转
47.5N·m

Forward / Reverse rotation change
Turn the reversing lever to the A side for clockwise rotation or to the B side for counterclockwise rotation
Perubahan putaran maju / belakang 正转 / 反转变化



LED job light
Lampu kerja LED
LED工作灯

Switch lever
Tukar tuil
切换杆

Compatible with variable sockets with socket adaptor
Sesuai dengan soket yang berubah-ubah dengan penyesuaian soket 与带有插座适配器的可变插座兼容



Standard Equipment
Peralatan Standard
标准装备



Able to tighten 13mm nut onto M8 threaded rod
Kipas swing automatik
自动摆



13mm nut only

WR100DWA | **WR100DZ** 9.5mm (3/8")
RM1,605 | RM 1,222

Cordless Ratchet Wrench
Perengkuh Ratchet Tanpa Kord
充电式棘轮扳手

- Supplied with Two Socket Adaptors for Compatibility with a Variety of Sockets



Standard Equipment:
Socket Adaptor 9.5mm & 6.35mm

- WA: 1x Standard Charger, 1x 2.0Ah Battery, 1x Tool Bag
- Z: Without Charger & Battery



Capacity Kapasiti 能力	Standard Bolt: M5 - M12 (3/16" - 1/2") High Tensile Bolt: M5 - M10 (3/16" - 3/8")
Square Drive Kepala Segi Empat 方形头	9.5mm (3/8") 6.35mm (1/4")
No Load Speed (RPM) Kelajuan Tanpa Beban 回转速	0 - 800
Max Fastening Torque Tenaga Pemutaran Pengancing Maksimum 最快扭转	47.5N-m (420in.lbs.)
Dimensions (L x W x H) Dimensi 体积	341x67x63mm (13-7/16"x2-5/8"x2-1/2")
Net Weight Berat Bersih 淨重	1.0 - 1.2kg (2.3 - 2.7lbs.)

* All list price shown are for reference only (exclude SST).

* Semua harga yang ditunjukkan adalah untuk rujukan sahaja (tidak termasuk SST). 所有显示的建议零售价仅供参考 (不包括SST)。

Cordless
Target Speed 3.5m/s

LED Flashlight
Lampu Kerja LED
LED工作灯

Vacuum Cleaner
Penyedut Vakuum
吸尘器

Drilling / Fastening
Guaht / Pengancing
钻孔 / 紧固

Impact Drilling / Demolition
Guaht Impak / Hancurkan
冲击钻孔 / 拆除

Cutting
Pemotong
切割

Grinding / Sanding
Pergilas / Ratahkan
磨削 / 打磨

Sawing
Guaht
锯切

Planing / Routing
Pegilas / Tonggah
刨削 / 开槽

Others
Lain-lain
其他

Outdoor Power Equipment
Alatan Kuat Ukir
户外动力设备

Makita
1 INT

12V_{max}

CXT

Li-ion Ah 4.0 2.0 1.5

HR166DSMJ | **HR166DWAJ** | **HR166DZ** 16mm (5/8")
 RM 1,787 | RM 1,523 | RM 957

Cordless Rotary Hammer
 Tukul Putar Tanpa Kord
 充电式电钻



• 2-Mode operation for Rotation Only or Hammering with Rotation

Standard Equipment: Side Grip, Depth Gauge

- SMJ: 1x Speed Charger, 2x 4.0Ah Battery, 1x Makpac Connector Box
- WAJ: 1x Standard Charger, 2x 2.0Ah Battery, 1x Makpac Connector Box
- Z: Without Charger, Battery & Carrying Case



Impact Energy Kekuatan Impak 单次最大冲击力	EPTA-Procedure 05/2009: 1.1J Our experimental conditions: 1.0J
Capacity Kapasiti 能力	Concrete: 16mm (5/8") Steel: 10mm (3/8") Wood: 13mm (1/2")
Impacts Per Minute (IPM) Impak Per Minit 冲击数	0 - 4,800
No Load Speed (RPM) Kelajuan Tanpa Beban 回转数	0 - 680
Dimensions (L x W x H) Dimensi 体积	BL1021B: 250x74x187mm (9-7/8"x2-15/16"x7-3/8")
Net Weight Berat Bersih 淨重	1.8 - 2.4kg (4.1 - 5.4lbs)
Work Amount (approx.) Jumlah Kerja 工作量	42 holes with BL1021B Mansory drill ø6mm (Concrete 40N/mm2 Depth 40mm)



HR166D

Models and specs may vary by country

HR140DWYE1 14mm (9/16")
 RM 1,787

Cordless Rotary Hammer
 Tukul Putar Tanpa Kord
 充电式电钻



• 2-Mode operation for Rotation Only or Hammering with Rotation

Standard Equipment: Side Grip, Depth Gauge

- WYE1: 1x Standard Charger, 2x 1.5Ah Battery, Accessories Set



Impact Energy Kekuatan Impak 单次最大冲击力	EPTA-Procedure 05/2009: 1.0J Our experimental conditions: 0.9J
Capacity Kapasiti 能力	Concrete: 14mm (9/16") Steel: 10mm (3/8") Wood: 13mm (1/2")
Impacts Per Minute (IPM) Impak Per Minit 冲击数	0 - 4,900
No Load Speed (RPM) Kelajuan Tanpa Beban 回转数	0 - 850
Dimensions (L x W x H) Dimensi 体积	BL1021B: 246x74x179mm (9-11/16"x2-15/16"x3-7/8") BL1041B: 246x74x198mm (9-11/16"x2-15/16"x7-3/4")
Net Weight Berat Bersih 淨重	1.9 - 2.6kg (4.3 - 5.6lbs)
Work Amount (approx.) Jumlah Kerja 工作量	32 holes with BL1021B Mansory drill ø6mm (Concrete 40N/mm2 Depth 40mm)

TL064DSME | **TL064DWAJ** | **TL064DZ**
 RM 1,923 | RM 1,658 | RM 1,095

Cordless Angle Impact Driver
 Pemutar Skru Impak Sudut
 Tanpa Kord
 充电式角向冲击螺丝起子机



• Compact & lightweight for fastening and loosening in tight spaces

Standard Equipment: Phillips Bit, Belt Clip

- SME: 1x Speed Charger, 2x 4.0Ah Battery
- WAE: 1x Standard Charger, 2x 2.0Ah Battery
- Z: Without Charger, Battery & Carrying Case



Capacity Kapasiti 能力	Machine Screw: M4 - M8 (5/32" - 5/16") Standard Bolt: M4 - M12 (5/32" - 1/2") High Tensile Bolt: M4 - M8 (5/32" - 5/16") Coarse thread (in length): 22 - 75mm (7/8" - 2-31/32") 6.35mm (1/4")
Hex Shank Batang Heksagon 六角柄	
No Load Speed (RPM) Kelajuan Tanpa Beban 回转数	0 - 2,000
Impacts Per Minute (IPM) Impak Per Minit 冲击数	0 - 3,000
Max Fastening Torque Maksimum Tenaga Pemutaran Pengancing 最快扭力	60N-m (530in.lbs.)
Dimensions (L x W x H) Dimensi 体积	361x66x86mm (14-1/4"x2-5/8"x3-3/8")
Net Weight Berat Bersih 淨重	1.2 - 1.6kg (2.7 - 3.6lbs)
Work Amount (approx.) Jumlah Kerja 工作量	933 pcs with BL1021B Machine Screw M8 x 16mm

TL065DSME | **TL065DWAJ** | **TL065DZ**
 RM 2,010 | RM 1,747 | RM 1,182

Cordless Angle Impact Wrench
 Perengkuh Impak Sudut
 Tanpa Kord
 充电式角向冲击套筒扳手



• Compact & lightweight for fastening and loosening in tight spaces

Standard Equipment: Belt Clip

- SME: 1x Speed Charger, 2x 4.0Ah Battery
- WAE: 1x Standard Charger, 2x 2.0Ah Battery
- Z: Without Charger, Battery & Carrying Case



Capacity Kapasiti 能力	Standard Bolt: M4 - M12 (5/32" - 1/2") High Tensile Bolt: M4 - M8 (5/32" - 5/16") 9.5mm (3/8")
Square Drive Batang Segi Empat 四方头	
No Load Speed (RPM) Kelajuan Tanpa Beban 回转数	0 - 2,000
Impacts Per Minute (IPM) Impak Per Minit 冲击数	0 - 3,000
Max Fastening Torque Maksimum Tenaga Pemutaran Pengancing 最快扭力	60N-m (530in.lbs.)
Dimensions (L x W x H) Dimensi 体积	361x66x86mm (14-1/4"x2-5/8"x3-3/8")
Net Weight Berat Bersih 淨重	1.2 - 1.6kg (2.7 - 3.6lbs)
Work Amount (approx.) Jumlah Kerja 工作量	933 pcs with BL1021B Machine Screw M8 x 16mm

DA332DWAJ | **DA332DZ** 10mm (3/8")
 RM 1,223 | RM 658

Cordless Angle Drill
 Gerudi Sudut Tanpa Kord
 充电式角向电钻



• Up to 40% faster drilling and 380% longer runtime**

Standard Equipment: Chuck Key, Chuck Key Holder, Phillips Bit, Belt Clip

- WAE: 1x Standard Charger, 2x 2.0Ah Battery
- Z: Without Charger, Battery & Carrying Case



Capacity Kapasiti 能力	Steel: 10mm (3/8") Wood: 12mm (1/2") 0 - 1,100
No Load Speed (RPM) Kelajuan Tanpa Beban 回转数	
Head Height Ketinggian Kepala 高度	63mm (2-1/2")
Center Height Pusat Tinggi 中心高度	23.5mm (15/16")
Dimensions (L x W x H) Dimensi 体积	BL1021B: 313x68x86mm (12-3/8"x2-11/16"x3-3/8") BL1041B: 332x68x86mm (13-1/8"x2-11/16"x3-3/8") 1.2 - 1.3kg (2.6 - 2.9lbs)
Net Weight Berat Bersih 淨重	
Work Amount (approx.) Jumlah Kerja 工作量	600 pcs with BL1021B Wood Screw ø4.1 x 38mm

* All list price shown are for reference only (exclude SST).

** Semua harga yang ditunjukkan adalah untuk rujukan sahaja (tidak termasuk SST). 所有显示的建议零售价仅供参考 (不包括SST)。

Cordless Impact Driver
 LED Flashlight
 Vacuum Cleaner
 Drilling / Fastening
 Impact Drilling / Demolition
 Cutting / Finishing
 Grinding / Sanding
 Sawing / Grouting
 Planing / Routing
 Others
 Outdoor Power Equipment



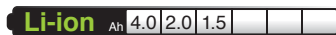

TM30DWA RM 1,087 | **TM30DWAEX1** RM 1,200 | **TM30DZ** RM 522

Cordless Multi Tool
Mesin Pemotong Berbilang Fungsi Tanpa Kord
充电式多功能切割打磨机



- 12 Angle settings at every 30° from 0° to 360°

Standard Equipment: Hex Wrench

- WAE: 1x Standard Charger, 2x 2.0Ah Battery
- WAEX1: 1x Standard Charger, 2x 2.0Ah Battery, Accessories Set (Plunge Cut Saw Blade 28 (B-21353), Segment Saw Blade 85 (B-21325), Sanding Pad (B-46202))
- Z: Without Charger, Battery & Carrying Case



Oscillations Per Minute (OPM) Kelajuan Ayunan 摆动速度	6,000 - 20,000
Oscillation Angle Sudut Ayunan 摆动角度	Left: 1.6° Right: 1.6° Total: 3.2°
Dimensions (L x W x H) Dimensi 体积	277x65x98mm (10-7/8"x2-9/16"x3-7/8")
Net Weight Berat Bersih 净重	1.1 - 1.3kg (2.3 - 2.9lbs)
Continuous Usage Time (approx.) Masa Penggunaan Berterusan 连续使用时间	16 min with BL1021B

CP100DWA RM 885 | **CP100DZ** RM 502

Cordless Multi Cutter
Pemotong Pelbagai Fungsi Tanpa Kord
充电式多功能电剪



- Cuts thin and thick material up to 6mm such as cardboard, carpet, fabrics, leather, CD, DVD & Blu-ray

Standard Equipment: Blade

- WA: 1x Standard Charger, 1x 2.0Ah Battery, Tool Bag
- Z: Without Charger & Battery



Max Cutting Capacity Kapasiti Pemotongan Maksimum 最大切割能力	6mm (1/4")
No Load Speed (RPM) Kelajuan Tanpa Beban 回转数	300
Dimensions (L x W x H) Dimensi 体积	BL1021B: 272x66x120mm (10-3/4"x2-5/8"x4-3/4") BL1041B: 291x66x121mm (11-1/2"x2-5/8"x4-3/4")
Net Weight Berat Bersih 净重	0.72 - 0.88kg (1.6 - 1.9lbs)
Work Amount (approx.) Jumlah Kerja 工作量	800 m with BL1021B Cardboard Carton 5mm (T) 500mm (L)

Cordless Threaded Rod Cutter

Pemotong Batang Keluli Tanpa Kord 充电式螺纹杆切割机

Lightweight
Ringan 轻量
2.8kg
with BL1041B
4.0Ah Battery

Reversing switch lever
Tuas suis terbalik 反转变化开关杆

Maximum Cutting Capacity
Kapasiti Pemotongan Maksimum 最大切割能力
Mild Steel: **M10**
Stainless Steel: **W3/8**

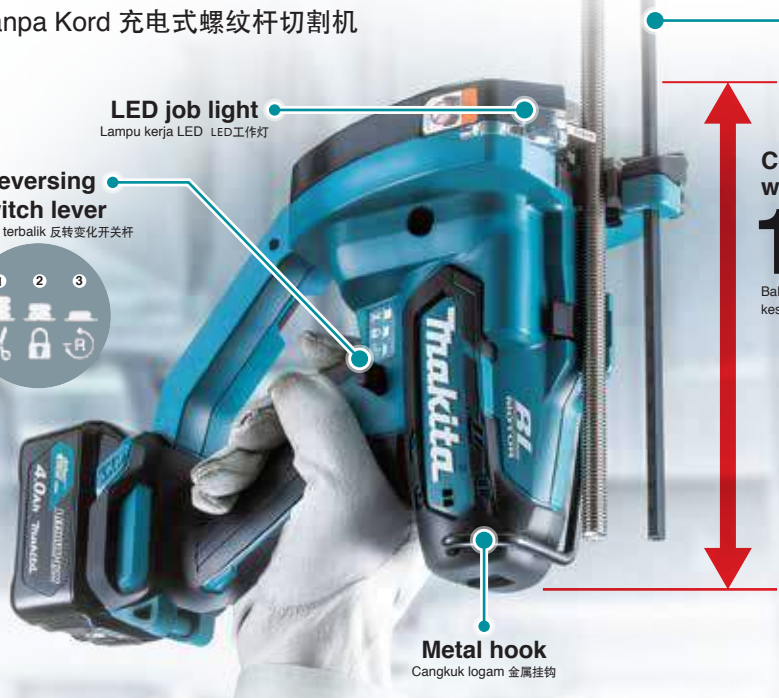

Guide scale
Panjang hos 软管长度

Compact motor section with overall length of 177mm
Bahagian motor padat dengan panjang keseluruhan 177mm 紧凑的电机全长177mm

Clean cut surface
Burr-free cuts allow for easy nut tightening
Permukaan pemotong yang bersih untuk mengetatkan skru dengan mudah
干净的切割表面易于拧紧螺母

SC103DZJ RM 6,083

Cordless Threaded Rod Cutter
Pemotong Batang Keluli Tanpa Kord
充电式螺纹杆切割机



- More Compact & High Productivity

Standard Equipment: Cutter Blade, Hex socket head bolt, Blade Cover, Depth Gauge, Thumb screw, Hex Wrench

- ZJ: With 1x Makpac Connector Box, Without Charger & Battery



Max Cutting Capacity Kapasiti Pemotongan Maksimum 最大切割能力	Mild Steel: M10 Stainless Steel: W3/8
Min. Cutting Length Panjang Pemotongan Minimum 最小切割长度	20mm (13/16")
Dimensions (L x W x H) Dimensi 体积	180x107x289mm (7-1/8"x4-1/4"x11-3/8")
Net Weight Berat Bersih 净重	2.7 - 2.8kg (6.0 - 6.2lbs.)
Work Amount (approx.) Jumlah Kerja 工作量	550 pcs with BL1041B Mild Steel M10

* All list price shown are for reference only (exclude SST).

* Semua harga yang ditunjukkan adalah untuk rujukan sahaja (tidak termasuk SST). 所有显示的建议零售价仅供参考 (不包括SST)。

Cordless
Targeted for use

LED Flashlight
Lampu Flash LED
LED照明灯

Vacuum Cleaner
Penyedut Vakuum
吸尘器

Drilling / Fastening
Guaian / Pasang
钻孔 / 紧固

Impact Drilling / Demolition
Guaian / Pasang
冲击钻孔 / 拆除

Cutting
Pemotong
切割

Grinding / Sanding
Pergasi / Pasah
打磨 / 磨光

Sawing
Guaian
锯切

Planing / Routing
Pegayaan / Tangan
刨平 / 开槽

Others
Lain-lain
其他

Outdoor Power Equipment
Alatan Kerja Luar
户外动力设备

12V_{max}

CXT

Li-ion Ah 4.0 2.0 1.5

CC301DWME RM 1,513 | **CC301DWAE** RM 1,332 | **CC301DZ** 85mm (3-3/8") RM 765

Cordless Cutter
Pemotong Tanpa Kord
充电式切割机



- Designed for cutting glass and ceramic tile

Standard Equipment: Diamond Wheel, Water Supply Tank Assembly, Hex Wrench

- WME: 1x Standard Charger, 2x 4.0Ah Battery
- WAE: 1x Standard Charger, 2x 2.0Ah Battery
- Z: Without Charger, Battery & Carrying Case



Blade Diameter Diameter Bilah 锯片直径	85mm (3-3/8")
Max Cutting Capacity Kapasiti Pemotongan Maksimum 最大切割能力	90°: 25.5mm (1") 45°: 16.5mm (5/8")
No Load Speed (RPM) Kelajuan Tanpa Beban 回转数	1,600
Tank Capacity Kapasiti Tangki 水箱容量	Water : 0.5L
Dimensions (L x W x H) Dimensi 体积	313x170x125mm (12-3/8"x6-11/16"x4-7/8")
Net Weight Berat Bersih 淨重	1.9kg (4.1lbs)
Work Amount (approx.) Jumlah Kerja 工作量	1.5 pcs with BL1021B Diamond Blade, Glass 10 x 300mm

HS301DSME RM 1,368 | **HS301DWAE** RM 1,105 | **HS301DZ** 85mm (3-3/8") RM 540

Cordless Circular Saw
Gergaji Piring Tanpa Kord
充电式圆锯



- Fast cutting of plywood, MDF, pegboard, particleboard, melamine, drywall and more

Standard Equipment: TCT Saw Blade (B-14607), Hex Wrench

- SME: 1x Speed Charger, 2x 4.0Ah Battery
- WAE: 1x Standard Charger, 2x 2.0Ah Battery
- Z: Without Charger, Battery & Carrying Case



Blade Diameter Diameter Bilah 锯片直径	85mm (3-3/8")
Max Cutting Capacity Kapasiti Pemotongan Maksimum 最大切割能力	90°: 25.5mm (1") 45°: 16.5mm (5/8")
No Load Speed (RPM) Kelajuan Tanpa Beban 回转数	1,500
Dimensions (L x W x H) Dimensi 体积	313x170x155mm (12-3/8"x6-11/16"x6-1/8")
Net Weight Berat Bersih 淨重	1.6 - 1.7kg (3.5 - 3.8lbs)
Work Amount (approx.) Jumlah Kerja 工作量	140 cuts with BL1021B Sawing (SPF 1"x4" 0 Degree Cut)

SD100DAJ RM 1,905 | **SD100DZ** RM 1,340

Cordless Drywall Saw
Gergaji Drywall Tanpa Kord
充电式石膏板切割机



- Ideal for cutting holes in drywalls when setting ceiling lights, air vents etc

Standard Equipment: Blade, Blade Cover, Base Cover, Hex Wrench

- WAJ: 1x Standard Charger, 2x 2.0Ah Battery, 1x Makpac Connector Box
- Z: Without Charger, Battery & Carrying Case



Strokes Per Minute (SPM) Kelajuan Strok 冲程速度	0 - 6,000
Length of Stroke Panjang Strok 冲程长度	6mm (1/4")
Capacity Kapasiti 能力	Drywall: 30mm (1-3/16") Wood: 15mm (9/16")
Dimensions (L x W x H) Dimensi 体积	239x79x266mm (9-3/8"x3-1/8"x10-1/2")
Net Weight Berat Bersih 淨重	1.4 - 1.6kg (3.2 - 3.5lbs)
Work Amount (approx.) Jumlah Kerja 工作量	50 m with BL1021B Cutting (Gypsum Board Thickness 9.5mm/ 2ply)

JV101DWAE RM 1,050 | **JV101DWYE** RM 995 | **JV101DZ** RM 485

Cordless Jig Saw
Gergaji Jig Tanpa Kord
充电式线锯机

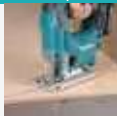

- Aluminum die-cast base adjusts from 0°-45° right to left

Standard Equipment: Jig Saw Blade B-10 (A-85628), Hex Wrench

- WAE: 1x Standard Charger, 2x 2.0Ah Battery
- WYE: 1x Standard Charger, 2x 1.5Ah Battery
- Z: Without Charger, Battery & Carrying Case



Max Cutting Capacity at 90° Kapasiti Pemotongan Maksimum 最大切割能力	Wood: 65mm (2-9/16") Aluminum: 4mm (5/32") Mild Steel: 2mm (1/16")
Length of Stroke Panjang Strok 冲程长度	18mm (11/16")
Strokes Per Minute (SPM) Kelajuan Strok 冲程速度	0-2,900
Dimensions (L x W x H) Dimensi 体积	232x76x196mm (9-1/8"x3"x7-3/4")
Net Weight Berat Bersih 淨重	1.8 - 1.9kg (3.9 - 4.3lbs)
Work Amount (approx.) Jumlah Kerja 工作量	60 pcs with BL1021B Sawing (Plywood 300mm Long x 12mm thickness)

JV103DSMJ RM 1,838 | **JV103DAJ** RM 1,573 | **JV103DZ** RM 1,008

Cordless Jig Saw
Gergaji Jig Tanpa Kord
充电式线锯机



- Up to 2.2X Faster Cutting & 2.2X Longer Runtime**

Standard Equipment: Jig Saw Blade B-10 (A-85628), Hex Wrench

- SMJ: 1x Speed Charger, 2x 4.0Ah Battery, 1x Makpac Connector Box
- WAJ: 1x Standard Charger, 2x 2.0Ah Battery, 1x Makpac Connector Box
- Z: Without Charger, Battery & Carrying Case



Max Cutting Capacity at 90° Kapasiti Pemotongan Maksimum 最大切割能力	Wood: 90mm (3-1/2") Aluminum: 20mm (13/16") Mild Steel: 10mm (3/8")
Length of Stroke Panjang Strok 冲程长度	23mm (7/8")
Strokes Per Minute (SPM) Kelajuan Strok 冲程速度	800 - 3,000
Dimensions (L x W x H) Dimensi 体积	237x76x206mm (9-3/8"x3"x8-1/8")
Net Weight Berat Bersih 淨重	1.9 - 2.0kg (4.1 - 4.4lbs)
Work Amount (approx.) Jumlah Kerja 工作量	90 pcs with BL1021B Sawing (Plywood 300mm Long x 12mm thickness)

* All list price shown are for reference only (exclude SST).

* Semua harga yang ditunjukkan adalah untuk rujukan sahaja (tidak termasuk SST). 所有显示的建议零售价仅供参考 (不包括SST)。

Cordless
Tanpa Kord 充电式

LED Flashlight
Lampu Suluh LED
LED 手电筒

Vacuum Cleaner
Penisihiti Vakuam
吸尘器

Drilling / Fastening
Gergaji / Pengikat
电钻 / 紧固件

Impact Drilling / Demolition
Gergaji / Pemusnah
电钻 / 拆除工具

Cutting
Pemotong
切割

Grinding / Sanding
Pengisar / Habis
打磨 / 砂纸

Sawing
Gergaji
锯切

Planing / Routing
Pegangan / Tonggah
刨平 / 铣床

Others
Lain-lain
其他

Outdoor Power Equipment
Alatan Kuasa Luar
户外动力设备

Makita
MAKITA

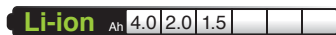

JV102DZ

RM 1,008

Cordless Jig Saw
Gergaji Jig Tanpa Kord
充电式线锯机



- Up to 2.2X Faster Cutting & 2.2X Longer Runtime*



VIDEO CLIP
Models and specs may vary by country

Standard Equipment:
Jig Saw Blade B-10 (A-85628), Hex Wrench

- Z: Without Charger & Battery



Max Cutting Capacity at 90° Kapasiti Pemotongan Maksimum 最大切割能力	Wood: 90mm (3-1/2") Aluminum: 20mm (13/16") Mild Steel: 10mm (3/8")
Length of Stroke Panjang Strok 冲程长度	23mm (7/8")
Strokes Per Minute (SPM) Kelajuan Strok 冲程速度	800 - 3,000
Dimensions (L x W x H) Dimensi 体积	237x76x186mm (9-3/8"x3"x7-3/8")
Net Weight Berat Bersih 净重	1.8 - 1.9kg (3.9 - 4.2lbs)
Work Amount (approx.) Jumlah Kerja 工作量	290 pcs with BL1021B Sawing (Plywood 300mm Long x 12mm thickness)

PT354DZ

RM 2,378

Cordless Pin Nailer
Mesin Pemaku Tanpa Kord
充电式打钉机



- Ergonomically designed handle with soft grip provides increased comfort

Standard Equipment: Nose Adapter, Safety Goggles, Belt Clip, Hex Wrench

- Z: Without Charger & Battery



Capacity Kapasiti 能力	Length: 15, 18, 25, 30, 35mm (5/8", 11/16", 1", 1-3/16", 1-3/8") Dia.: 0.6mm (1/32") Gauge: 23Ga
Magazine Capacity Bilangan Staples 装订个数	120
Dimensions (L x W x H) Dimensi 体积	231x66x226mm (9-1/8"x2-5/8"x8-7/8")
Net Weight Berat Bersih 净重	1.8 - 2.0kg (4.0 - 4.4lbs)
Work Amount (approx.) Jumlah Kerja 工作量	1333 pcs with BL1021B Pin nail
Accessories (optional)	
Description	Size Pcs/ Box Part No.
Pin Nail 18mm (11/16")	P18 10,000 F-31825
Pin Nail 25mm (1")	P25 10,000 F-31838
Pin Nail 30mm (1-3/16")	P30 10,000 F-31841
Pin Nail 35mm (1-3/8")	P35 10,000 F-31854

ST113DWAJ | ST113DZ

RM 2,553

RM 1,987

Cordless Stapler
Stapler Tanpa Kord
充电式钉枪



- Compact and lightweight for reduced operator fatigue

Standard Equipment:
Safety Goggles (195246-2), Belt Clip

- WAJ: 1x Standard Charger, 2x 2.0Ah Battery, 1x Makpac Connector Box
- Z: Without Charger, Battery & Carrying Case



*Not applicable for Z model



Staple Staple 钉种	Width: 10mm (3/8") Length: 7 - 10mm(9/32" - 3/8") Gauge: 0.5 x 0.7mm
Magazine Capacity Bilangan Staples 装订个数	150 (max 160)
Dimensions (L x W x H) Dimensi 体积	211x81x159mm (8-5/16"x3-3/16"x6-1/4")
Net Weight Berat Bersih 净重	1.3kg (2.9lbs.)
Work Amount (approx.) Jumlah Kerja 工作量	2666 pcs with BL1021B Stapler width 10mm
Accessories (optional)	
Description	Length Pcs/ Box Part No.
Staple RT10mm	10mm 15,000 F-81521
Staple RT7mm	7mm 25,000 F-81518

CG100DZA

RM 1,383

Cordless Caulking Gun
Alat Tembak Silikon Tanpa Kord
充电式填缝枪



- 5 Speed dial optimizes flow rate 0 - 28mm/sec

Standard Equipment: Holder, Holder Joint, Piston, Rack 42, Safety Goggles

- ZA: Without Charger & Battery



VIDEO CLIP
Models and specs may vary by country

Max Dispensing Force Tujahan Maksimum 最大推力	5,000N (1,100lbs)
No Load Speed Kelajuan Tanpa Beban 回转数	0 - 28mm/sec. (0 - 66in/min.)
Holder Size Kapasiti 容量	300mL (Optional Accessories 600mL, 800mL Holder)
Dimensions (L x W x H) Dimensi 体积	404x108x259mm (15-7/8"x4-1/4"x10-1/4")
Net Weight Berat Bersih 净重	1.9 - 2.6kg (4.2 - 5.8lbs)
Work Amount (approx.) Jumlah Kerja 工作量	150 pcs with BL1016 300ml silicon sealant

JR105DWAJ | JR105DZ

RM 1,070

RM 505

Cordless Recipro Saw
Gergaji Resipro Tanpa Kord
充电式往复锯



- Cuts PVC, ABS pipe, EMT, drywall, wood & more

Standard Equipment: Hex Wrench, Recipro Saw Blades 2pcs (B-20404 & B-20432)

- WAE: 1x Standard Charger, 2x 2.0Ah Battery
- Z: Without Charger, Battery & Carrying Case



*Not applicable for Z model

Length of Stroke Panjang Strok 冲程长度	13mm (1/2")
Strokes Per Minute (SPM) Kelajuan Strok 冲程速度	0 - 3,300
Capacity Kapasiti 能力	Pipe: 50mm (2") Wood: 50mm (2")
Dimensions (L x W x H) Dimensi 体积	376x66x186mm (14-3/4"x2-5/8"x7-3/8")
Net Weight Berat Bersih 净重	1.3 - 1.5kg (2.9 - 3.2lbs)
Work Amount (approx.) Jumlah Kerja 工作量	45 pcs with BL1021B Cutting (PVC plastic hose 48mm)

* All list price shown are for reference only (exclude SST).

* Semua harga yang ditunjukkan adalah untuk rujukan sahaja (tidak termasuk SST). 所有显示的建议零售价仅供参考 (不包括SST)。





Cordless
Tampal Kord Tanpa Kord
LED Flashlight
Lampu Suluh LED
LED ON/OFF
Vacuum Cleaner
Penisih Hiti Vakuum
MELUK
Drilling / Fastening
Ganda / Pemisah
BURU / BURU
Impact Drilling / Demolition
Ganda / Pemisah
BURU GANDA / BURU GANDA
Cutting
Pemotong
BURU
Grinding / Sanding
Pengisar / Poles
BURU / BURU
Sawing
Ganda
BURU
Planing / Routing
Pengisar / Pengisar
BURU / BURU
Others
Lain-lain
BURU
Outdoor Power Equipment
Alatan Kuasa Luar
BURU - BURU
Makita
100%

UH353DWA 350mm (13-3/4")

RM 1,095

Cordless Hedge Trimmer

Pemangkas Tanaman Pagar Tanpa Kord
充电式篱笆修剪机

- Lightweight. Low Vibration. Low Noise

Standard Equipment: Blade Cover

- WA: 1x Standard Charger, 1x 2.0Ah Battery



Blade Length Panjang bilah 刀片长度	350mm (13-3/4")
Tooth Spacing Selang Gigi 牙齿间隔	28mm (1-1/8")
Max Cutting Capacity Kapasiti Pemotongan Maksimum 最大切割能力	15mm (9/16")
Strokes Per Minute (SPM) Kelajuan Strok 冲程速度	3,300
Dimensions (L x W x H) Dimensi 体积	693x175x165mm (27-1/4"x6-7/8"x6-1/2")
Net Weight Berat Bersih 淨重	1.9 - 2.1 kg (4.2 - 4.5 lbs.)
Continuous Usage Time Masa Penggunaan Berterusan 连续使用时间	40 min with BL1021B

UH201DWAX | UH201DZ 200mm (7-7/8")
RM 915 | RM 450

Cordless Hedge Trimmer

Pemangkas Tanaman Pagar Tanpa Kord
充电式篱笆修剪机

- Dual blade action cuts quickly with a shearing effect

Standard Equipment: Blade Cover, Chip Receiver

- WAX: 1x Standard Charger, 1x 2.0Ah Battery, 1x Grass Shear Blade, 1x Grass Receiver
- Z: Without Charger & Battery



Blade Length Panjang Bilah 刀片长度	200mm (7-7/8")
Tooth Spacing Selang Gigi 牙齿间隔	26mm (1")
Strokes Per Minute (SPM) Kelajuan Strok 冲程速度	2,500
Dimensions (L x W x H) Dimensi 体积	504x120x131mm (19-7/8"x4-3/4"x5-1/8")
Net Weight Berat Bersih 淨重	1.3 - 1.5kg (2.8 - 3.3lbs)
Continuous Usage Time (approx.) Masa Penggunaan Berterusan 连续使用时间	45 min with BL1021B

UM600DWA | UM600DZ 160mm (6-5/16")
RM 940 | RM 557

Cordless Grass Shear

Pemotong Rumput Tanpa Kord
充电式割草机

- 2 in 1: Both trimmer blade and shear blade can be attached

Standard Equipment: Grass Receiver, Blade Cover

- WA: 1x Standard Charger, 1x 2.0Ah Battery
- Z: Without Charger & Battery



Cutting Width Lebar Keratan 切割宽度	160mm (6-5/16")
Depth Adjustment Pelarasan Kedalaman 深度调整	15mm (9/16") 20mm (13/16") 25mm (1")
Strokes Per Minute (SPM) Kelajuan Strok 冲程速度	2,500
Dimensions (L x W x H) Dimensi 体积	329x177x131mm (13"x7"x5-1/8")
Net Weight Berat Bersih 淨重	1.3 - 1.5kg (2.8 - 3.3lbs)
Continuous Usage Time (approx.) Masa Penggunaan Berterusan 连续使用时间	45 min with BL1021B

UR100DSME | UR100DZ
RM 1,457 | RM 628

Cordless Grass Trimmer

Pemotong Rumput tanpa Kord
充电式割草机

- Well balanced design with fully adjustable features to suit any operator

Standard Equipment: Band Assembly, Nylon Cutting Head, Nylon Cord, Accessory Bag, Hex Wrench

- SME: 1x Speed Charger, 2x 4.0Ah Battery
- Z: Without Charger & Battery



Cutting Width Lebar Keratan 切割宽度	Nylon Cutting Head: 260mm (10") Plastic Blade: 230mm (9")
No Load Speed (RPM) Kelajuan Tanpa Beban 回转数	Nylon Cutting Head: 9,000 Plastic Blade: 10,000
Spindle Size Saiz Spindel 主轴尺寸	M8 x 1.25RH
Dimensions (L x W x H) Dimensi 体积	835 - 1,185x267x210 - 315mm (32-7/8 - 46-2/3"x10-1/2"x8-1/4 - 12-1/3")
Net Weight Berat Bersih 淨重	2.1 - 2.3kg (4.4 - 4.9lbs.)
Continuous Usage Time (approx.) Masa Penggunaan Berterusan 连续使用时间	27 min with BL1021B

MP100DZ

RM 532

Cordless Inflator

Inflator Tanpa Kord
充电式打气机

- Inflates the Tires of Cars, Bikes, Sport Balls, etc

Standard Equipment: British Adapter, French Adapter, Ball Adapter, Swim Ring Adapter

- Z: Without Charger & Battery



VIDEO CLIP
Models and specs may vary by country



Max Air Pressure Udara Tekanan Maksimum 最大气压	830kPa (121 PSI) [8.3 bar]
Air Discharge Amount Pelepasan Udara 空气排放量	200kPa: 10L/min
Hose Length Panjang Hos 软管长度	65cm (25-1/2")
Dimensions (L x W x H) Dimensi 体积	235x74x173mm (9-1/4"x2-15/16"x6-13/16")
Net Weight Berat Bersih 淨重	1.2 - 1.3kg (2.6 - 3.0lbs.)
Work Amount (approx.) Jumlah Kerja 工作量	2 tires with BL1610 (16" Car Tires 215/60R16)

* All list price shown are for reference only (exclude SST).

* Semua harga yang ditunjukkan adalah untuk rujukan sahaja (tidak termasuk SST). 所有显示的建议零售价仅供参考 (不包括SST)。

12V_{max}

CXT

Li-ion Ah 4.0 2.0 1.5

Rechargeable Line Laser

Mesin Garis Laser Tanpa Kord 充电式激光水平仪



High brightness green laser for increased visibility at bright site

Laser hijau kecerahan tinggi 高亮度绿色激光

SK209GDZ | SK312GDZ GREEN
RM 7,065 | RM 8,338

Rechargeable Green Multi Line Laser

Mesin Garis Laser Tanpa Kord
充电式激光水平仪



- Horizontal line - 2-Vertical line - 2-Vertical line/ horizontal line (SK209GD)
- Horizontal line - Horizontal/ vertical line - 3-Vertical line/ horizontal line (SK312GD)

Standard Equipment: Laser Viewing Glass, Shoulder Strap, Storage Case

• Z : Without Charger & Battery



SK106DZ RED | SK106GDZ GREEN
RM 2,015 | RM 3,408

Rechargeable Red 4-point Cross Line Laser

Mesin Garis Laser Tanpa Kord
充电式激光水平仪

- Brightness selection: 2 Modes (Bright mode/ Eco mode)

Standard Equipment: Soft Bag, Target Plate

• Z : Without Charger & Battery



SK105DZ RED | SK105GDZ GREEN
RM 1,192 | RM 2,340

Rechargeable Red Cross Line Laser

Mesin Garis Laser Tanpa Kord
充电式激光水平仪

- Brightness selection: 2 Modes (Bright mode/ Eco mode)

Standard Equipment: Soft Bag, Target Plate

• Z : Without Charger & Battery



Horizontal / 2-Vertical lines

SK209GD

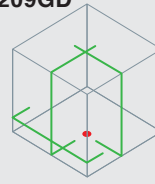

Horizontal / 3-Vertical lines

SK312GD

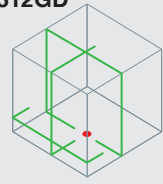

Cross line + Point

SK106D

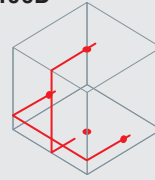

SK106GD

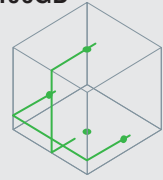

Cross line

SK105D



SK105GD

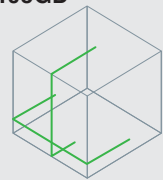

Leveling Accuracy Menunjukkan Ketepatan 指示精确度	±1mm/ 10m
Self-leveling Range Julat Indikasi Menegak 垂直指示范围	±2°
Laser Fan Angle Sudut Peminat Laser 激光扇角	Horizontal: 110°/ Vertical: 130°
Number of Laser Lines Bilangan Garisan Laser 激光线数量	3
Laser Type Jenis Laser 激光类型	Laser class 2: 515nm
Tripod Thread Tripod 脚架	5/8"
Protection Class Tahap Perlindungan 保护等级	IP54
Dimensions (L x W x H) Dimensi 体积	BL1021B: 122x110x225mm
Net Weight Berat Bersih 净重	1.5 - 1.6kg (3.3 - 3.5lbs)
Continuous Usage Time (approx.) Masa Penggunaan Berterusan 连续使用时间	7.5 - 20 hrs with BL1021B SK209GD 5 - 14 hrs with BL1021B SK312GD

Measuring Range Jarak Mengukur 测量范围	Up to: 25m SK106D Up to: 35m SK106GD
Measuring Range w/ detector Jarak Mengukur 测量范围	Up to: 80m
Leveling Accuracy Menunjukkan Ketepatan 指示精确度	±3mm/ 10m
Self-leveling Range Julat Indikasi Menegak 垂直指示范围	±4°
Laser Fan Angle Sudut Peminat Laser 激光扇角	Horizontal: 180°/ Vertical: 170°
Number of Laser Bilangan Laser 激光数量	Points : 4 Lines : 2
Laser Type Jenis Laser 激光类型	Laser class 2: 635nm SK106D Laser class 2: 525nm SK106GD
Dimensions (L x W x H) Dimensi 体积	138x64x102mm (5-7/16"x2-1/2"x4")
Net Weight Berat Bersih 净重	0.69 - 0.85kg (1.5 - 1.9lbs.)
Continuous Usage Time (approx.) Masa Penggunaan Berterusan 连续使用时间	7.5 - 20 hrs with BL1021B SK106D 3.5 - 10 hrs with BL1021B SK106GD

Measuring Range Jarak Mengukur 测量范围	Up to: 25m SK105D Up to: 35m SK105GD
Measuring Range w/ detector Jarak Mengukur 测量范围	Up to: 80m
Leveling Accuracy Menunjukkan Ketepatan 指示精确度	±3mm/ 10m
Self-leveling Range Julat Indikasi Menegak 垂直指示范围	±4°
Laser Fan Angle Sudut Peminat Laser 激光扇角	Horizontal: 180°/ Vertical: 160°
Number of Laser Lines Bilangan Garisan Laser 激光线数量	2
Laser Type Jenis Laser 激光类型	Laser class 2: 635nm SK105D Laser class 2: 525nm SK105GD
Dimensions (L x W x H) Dimensi 体积	138x64x102mm (5-7/16"x2-1/2"x4")
Net Weight Berat Bersih 净重	0.67 - 0.84 kg (1.5 - 1.9 lbs.)
Continuous Usage Time (approx.) Masa Penggunaan Berterusan 连续使用时间	7.5 - 20 hrs with BL1021B SK105D 3.5 - 10 hrs with BL1021B SK105GD

* All list price shown are for reference only (exclude SST).

* Semua harga yang ditunjukkan adalah untuk rujukan sahaja (tidak termasuk SST). 所有显示的建议零售价仅供参考 (不包括SST)。

Cordless
Target Spot Laser

LED Flashlight
Lampu Cahaya LED
LED照明灯

Vacuum Cleaner
Penyedut Vakuum
吸尘器

Drilling / Fastening
Gruat / Pasang
钻孔 / 紧固

Impact Drilling / Demolition
Gruat / Hancurkan
冲击钻孔 / 拆除

Cutting
Pemotong
切割

Grinding / Sanding
Pergasil / Ratah
打磨 / 磨平

Sawing
Gergaji
锯切

Planing / Routing
Pegilisan / Tumpang
刨平 / 嵌条

Others
Lain-lain
其他

Outdoor Power Equipment
Alatan Kuat Ukir
户外动力工具

Makita
INTL

10.8V

Li-ion Ah 1.3

Cordless Hammer Driver Drill

Tukul Pemutar Skru Bergerudi Tanpa Kord 充电式冲击螺丝起子电钻



DRILLING
Penggerudian 钻孔

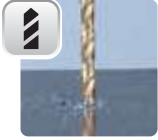

FASTENING
Pengetat 紧固

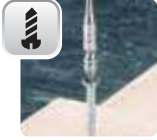

HAMMER DRILLING
Tukul Bergerudi 冲击电钻



HP330DWE 10mm (3/8")
RM 877

Cordless Hammer Driver Drill
Tukul Pemutar Skru Bergerudi Tanpa Kord
充电式冲击螺丝起子电钻

- Hammer drill mode



Standard Equipment: Phillips Bit, Holster

- WE: 1x Standard Charger, 2x 1.3Ah Battery



Capacity Kapasiti 能力	Steel: 10mm (3/8") Wood: 21mm (13/16") Masonry: 8mm (5/16")
Impacts Per Minute (IPM) Impak Per Minit 冲击数	High: 0-22,500 Low: 0-6,000
No Load Speed (RPM) Kelajuan Tanpa Beban 回转数	High: 0-1,500 Low: 0-400
Max Fastening Torque Maksimum Tenaga Pemutaran Pengancing 最快扭力	Hard: 24N·m Soft: 12N·m
Max Lock Torque Pemutaran Tenaga Maksimum 最大扭力	22N·m (200in.lbs.)
Dimensions (L x W x H) Dimensi 体积	201x53x183mm (7-7/8"x2-1/16"x7-1/4")
Net Weight Berat Bersih 淨重	1.1kg (2.3lbs)
Work Amount (approx.) Jumlah Kerja 工作量	220 holes with BL1013 Auger Bit Drilling Ø9mm, Melapi 30mm Thickness

DF330DWE 10mm (3/8")
RM 687

Cordless Driver Drill
Gerudi Pemutar Skru Tanpa Kord
充电式螺丝起子电钻

- 2-Speed design driver drill



Standard Equipment: Phillips Bit, Holster

- WE: 1x Standard Charger, 2x 1.3Ah Battery



Capacity Kapasiti 能力	Steel: 10mm (3/8") Wood: 21mm (13/16")
No Load Speed (RPM) Kelajuan Tanpa Beban 回转数	High: 0-1,300 Low: 0-350
Max Fastening Torque Maksimum Tenaga Pemutaran Pengancing 最快扭力	Hard: 24N·m Soft: 14N·m
Max Lock Torque Pemutaran Tenaga Maksimum 最大扭力	22N·m (200in.lbs.)
Dimensions (L x W x H) Dimensi 体积	189x53x183mm (7-7/16"x2-1/16"x7-1/4")
Net Weight Berat Bersih 淨重	1kg (2.2lbs)
Work Amount (approx.) Jumlah Kerja 工作量	220 holes with BL1013 Auger Bit Drilling Ø9mm, Melapi 30mm Thickness

DF030DWE 10mm (3/8")
RM 665

Cordless Driver Drill
Gerudi Pemutar Skru Tanpa Kord
充电式螺丝起子电钻

- 18 clutch settings and drill mode for added fastening control



Standard Equipment: Phillips Bit, Holster

- WE: 1x Standard Charger, 2x 1.3Ah Battery



Capacity Kapasiti 能力	Steel: 10mm (3/8") Wood: 21mm (13/16")
No Load Speed (RPM) Kelajuan Tanpa Beban 回转数	High: 0-1,300 Low: 0-350
Max Fastening Torque Maksimum Tenaga Pemutaran Pengancing 最快扭力	Hard: 24N·m Soft: 14N·m
Max Lock Torque Pemutaran Tenaga Maksimum 最大扭力	22N·m (200 in.lbs.)
Dimensions (L x W x H) Dimensi 体积	157x53x183mm (6-3/16"x2-1/16"x7-1/4")
Net Weight Berat Bersih 淨重	0.89kg (2.0lbs)
Work Amount (approx.) Jumlah Kerja 工作量	190 holes with BL1013 Wood Drill ø9mm

TD090DWE
RM 755

Cordless Impact Driver
Pemutar Skru Impak Tanpa Kord
充电式冲击螺丝起子机

- Compact bit sleeve 1/4" drive



Standard Equipment: Holster

- WE: 1x Standard Charger, 2x 1.3Ah Battery



Capacity Kapasiti 能力	Machine Screw: M4 - M8mm (5/32" - 5/16") Standard Bolt: M5 - M12 (3/16" - 1/2") High Tensile Bolt: M5 - M10 (3/16" - 3/8") Coarse thread (in length): 22 - 90mm (7/8" - 3-1/2")
No Load Speed (RPM) Kelajuan Tanpa Beban 回转数	0-2,400
Impacts Per Minute (IPM) Impak Per Minit 冲击数	0-3,000
Max Fastening Torque Maksimum Tenaga Pemutaran Pengancing 最快扭力	90N·m (800in.lbs.)
Dimensions (L x W x H) Dimensi 体积	155x54x178mm (6-1/8"x2-1/8"x7")
Net Weight Berat Bersih 淨重	0.92kg (2.0lbs)
Work Amount (approx.) Jumlah Kerja 工作量	550 pcs with BL1013 Bolts M8 x 16mm

* All list price shown are for reference only (exclude SST).

* Semua harga yang ditunjukkan adalah untuk rujukan sahaja (tidak termasuk SST). 所有显示的建议零售价仅供参考 (不包括SST)。

LED Flashlight
Lampu Suluh LED
LED 手电筒

Vacuum Cleaner
Penisihiti Vakuum
吸尘器

Drilling / Fastening
Gerudi / Pengetat
钻孔 / 紧固

Impact Drilling / Demolition
Gerudi / Pemusnah
冲击钻孔 / 拆除加工

Cutting
Pemotong
切割

Grinding / Sanding
Pengisar / Poles
磨削 / 打磨

Sawing
Gergaji
锯切

Planing / Routing
Pengayam / Tengam
刨平 / 刨花

Others
Lain-lain
其他

Outdoor Power Equipment
Alatan Kuasa Luar
户外动力设备



10.8V

Li-ion Ah 1.3

TD091DWE

RM 792

Cordless Impact Driver
Pemutar Skru Impak Tanpa Kord
充电式冲击螺丝起子机



- Battery power reduction warning lamp

• WE: 1x Standard Charger, 2x 1.3Ah Battery



440

Capacity Kapasiti 能力	Machine Screw: M4 - M8 (5/32" - 5/16") Standard Bolt: M5 - M12 (3/16" - 1/2") High Tensile Bolt: M5 - M10 (3/16" - 3/8") Coarse thread (in length): 22 - 90mm (7/8" - 3-1/2") 0 - 2,400
No Load Speed (RPM) Kelajuan Tanpa Beban 回转数	
Impacts Per Minute (IPM) Impak Per Minit 冲击数	0 - 3,000
Max Fastening Torque Maksimum Tenaga Pemutaran Pengancing 最快扭力	90N-m (800in.lbs.)
Dimensions (L x W x H) Dimensi 体积	134x54x200mm (5-1/4"x2-1/8"x7-7/8")
Net Weight Berat Bersih 净重	0.86kg (1.9lbs)
Work Amount (approx.) Jumlah Kerja 工作量	480 pcs with BL1013 Bolts M8x16mm

TW100DWE

RM 608

Cordless Impact Wrench
Perengkuh Impak Tanpa Kord
充电式冲击套筒扳手



- 9.5mm (3/8") square drive fits most common automotive sockets

• WE: 1x Standard Charger, 2x 1.3Ah Battery



Fastening Capacities Kapasiti 能力	Standard Bolt: M8 - M12 (5/16" - 1/2") High Tensile Bolt: M6 - M10 (1/4" - 3/8") 9.5mm (3/8")
Square Drive Batang Segi Empat 四方头	
No Load Speed (RPM) Kelajuan Tanpa Beban 回转数	0 - 2,300
Impacts Per Minute (IPM) Impak Per Minit 冲击数	0 - 3,000
Max Fastening Torque Maksimum Tenaga Pemutaran Pengancing 最快扭力	110N-m (1,000in.lbs.)
Dimensions (L x W x H) Dimensi 体积	163x54x178mm (6-3/8"x2-1/8"x7")
Net Weight Berat Bersih 净重	0.95kg (2.1lbs)
Work Amount (approx.) Jumlah Kerja 工作量	550 pcs with BL1013 Bolts M8x16mm

CC300DW

RM 987

CC300DZ

RM 710

Cordless Cutter
Pemotong Tanpa Wayar
充电式切割机



- Adjustable cutting depth up to 25.5mm at 90° and 16.5mm at 45°

Standard Equipment: Diamond Wheel, Water Supply Tank Assembly, Hex Wrench

- W: 1x Standard Charger, 1x 1.3Ah Battery
- Z: Without Charger, Battery & Carrying Case



Blade Diameter Diameter Bilah 锯片直径	85mm (3-3/8")
Max Cutting Capacity Kapasiti Pemotongan Maksimum 最大切割能力	90°: 25.5mm (1") 45°: 16.5mm (5/8")
No Load Speed (RPM) Kelajuan Tanpa Beban 回转数	1,400
Tank capacity Kapasiti Tangki 水箱容量	Water : 0.5L
Dimensions (L x W x H) Dimensi 体积	300x170x154mm (11-3/4"x6-11/16"x6-1/16")
Net weight Berat Bersih 净重	16kg (3.6lbs)
Work Amount (approx.) Jumlah Kerja 工作量	2.5 pcs with BL1013 Diamond Blade (Cut Glass 10x300mm)

HS300DW

RM 832

Cordless Circular Saw
Gergaji Piring Tanpa Kord
充电式圆锯



- Fast cutting of plywood, MDF, pegboard, particleboard, melamine, drywall and more

Standard Equipment: TCT Saw Blade (B-14607), Hex Wrench

- W: 1x Standard Charger, 1x 1.3Ah Battery



Blade Diameter Diameter Bilah 锯片直径	85mm (3-3/8")
Max Cutting Capacity Kapasiti Pemotongan Maksimum 最大切割能力	90°: 25.5mm (1") 45°: 16.5mm (5/8")
No Load Speed (RPM) Kelajuan Tanpa Beban 回转数	1,400
Dimensions (L x W x H) Dimensi 体积	300x170x154mm (11-3/4"x6-11/16"x6-1/16")
Net Weight Berat Bersih 净重	1.5kg (3.4lbs)
Work Amount (approx.) Jumlah Kerja 工作量	90 cuts with BL1013 Sawing SPF 1"x4" (0 Degree Cut)

JV100DWE

RM 865

Cordless Jig Saw
Gergaji Jig Tanpa Kord
充电式线锯机



- Aluminum die-cast base adjusts from 0°-45° right to left

Standard Equipment: Jig Saw Blade (B-10), Hex Wrench, Guide Rule

- WE: 1x Standard Charger, 2x 1.3Ah Battery



Max Cutting Capacity at 90° Kapasiti Pemotongan Maksimum 最大切割能力	Wood: 65mm (2-9/16") Aluminum: 4mm (5/32") Mild Steel: 2mm (1/16")
Length of Stroke Panjang Strok 冲程长度	18mm (11/16")
Strokes Per Minute (SPM) Kelajuan Strok 冲程速度	0 - 2,400
Dimensions (L x W x H) Dimensi 体积	231x76x196mm (9-1/8"x3"x7-3/4")
Net Weight Berat Bersih 净重	1.7kg (3.7lbs)
Work Amount (approx.) Jumlah Kerja 工作量	26 pcs with BL1013 Sawing (Fibreboard MDF 300x12mm)

* All list price shown are for reference only (exclude SST).

* Semua harga yang ditunjukkan adalah untuk rujukan sahaja (tidak termasuk SST). 所有显示的建议零售价仅供参考 (不包括SST)。

Cordless
Tangan Kord Tanpa Kord

LED Flashlight
Lampu Cahaya LED
LECOBRIGHT

Vacuum Cleaner
Penyedut Vakuum
吸尘器

Drilling / Fastening
Gergaji / Pengancing
电钻 / 电批

Impact Drilling / Demolition
Gergaji / Pemusnah
电钻 / 电批 / 电锤

Cutting
Pemotong
切割机

Grinding / Sanding
Pengisar / Habis
砂光机 / 砂纸

Sawing
Gergaji
圆锯

Planing / Routing
Penghalus / Tangan
刨花机 / 电刨

Others
Lain-lain
其他

Outdoor Power Equipment
Alatan Kerja Luar
户外机具

Makita
1 INT

10.8V

7.2V

Li-ion Ah 1.5 1.3 1.0

JR100DWE

RM 920

Cordless Recipro Saw

Gergaji Resipro Tanpa Kord
充电式往复锯



- Dual-position on/off switch design allows for either paddle or trigger switch operation



Standard Equipment: Recipro Saw Blades 2pcs (B-20404 & B-20432)

- WE: 1x Standard Charger, 2x 1.3Ah Battery



Capacity Kapasiti 能力	Pipe : 50mm (2") Wood: 50mm (2")
Length of Stroke Panjang Strok 冲程长度	13mm (1/2")
Strokes Per Minute (SPM) Kelajuan Strok 冲程速度	0-3,300
Dimensions (L x W x H) Dimensi 体积	355x63x146mm (14"x2-1/2"x5-3/4")
Net Weight Berat Bersih 淨重	1.2kg (2.6lbs)
Work Amount (approx.) Jumlah Kerja 工作量	55 pcs with BL1013 Cutting (PVC Plastic Hose 48mm)

JR102DWE

RM 885

Cordless Recipro Saw

Gergaji Resipro Tanpa Kord
充电式往复锯



- Accepts both Recipro and Jig saw blades



Standard Equipment: Hex Wrench,
Recipro Saw Blades 2pcs (B-20404 & B-20432)

- WE: 1x Standard Charger, 2x 1.3Ah Battery



Capacity Kapasiti 能力	Pipe : 50mm (2") Wood: 50mm (2")
Length of Stroke Panjang Strok 冲程长度	13mm (1/2")
Strokes Per Minute (SPM) Kelajuan Strok 冲程速度	0-3,300
Dimensions (L x W x H) Dimensi 体积	355x63x146mm (14"x2-1/2"x5-3/4")
Net Weight Berat Bersih 淨重	1.2kg (2.6lbs)
Work Amount (approx.) Jumlah Kerja 工作量	55 pcs with BL1013 Cutting (PVC Plastic Hose 48mm)

TD022DSE

RM 933

Cordless Impact Driver

Pemutar Skru Impak Tanpa Kord
充电式冲击螺丝起子机

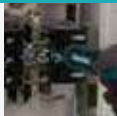

- Compact and lightweight design



Standard Equipment: Holster, Phillips Bit

- SE: 1x Standard Charger, 2x 1.5Ah Battery



Capacity Kapasiti 能力	Machine Screw: M3 - M8 (1/8" - 5/16") Standard Bolt: M3 - M8 (1/8" - 5/16") High Tensile Bolt: M3 - M6 (1/8" - 1/4") Coarse thread (in length): 22 - 45mm (7/8" - 1-3/4") 6.35mm (1/4")
Hex Shank Batang Heksagon 六角柄	
No Load Speed (RPM) Kelajuan Tanpa Beban 回转速数	0 - 2,450
Impacts Per Minute (IPM) Impak Per Minit 冲击数	0 - 3,000
Max Fastening Torque Maksimum Tenaga Pemutaran Pengancing 最快扭力	25N-m (220in.lbs.)
Dimensions (L x W x H) Dimensi 体积	Straight Style: 282x42x52mm (11-1/8"x1-5/8"x2-1/16") Pistol Style: 227x42x142mm (8-15/16"x1-5/8"x5-5/8")
Net Weight Berat Bersih 淨重	0.55 - 0.56kg (1.2lbs)
Work Amount (approx.) Jumlah Kerja 工作量	320 pcs with BL7010 Wood Screw ø3.1x25mm (Melapi Drove Wood)

TD020DSW

RM 710

Cordless Impact Driver

Pemutar Skru Impak Tanpa Kord
充电式冲击螺丝起子机



- Compact and lightweight design



Standard Equipment: Holster, Bit set

- SW: 1x Standard Charger, 1x 1.0Ah Battery (White)



Capacity Kapasiti 能力	Machine Screw: M3 - M8 (1/8" - 5/16") Standard Bolt: M3 - M8 (1/8" - 5/16") High Tensile Bolt: M3 - M6 (1/8" - 1/4") Coarse thread (in length): 22 - 45mm (7/8" - 1-3/4") 6.35mm (1/4")
Hex Shank Batang Heksagon 六角柄	
No Load Speed (RPM) Kelajuan Tanpa Beban 回转速数	2,300
Impacts Per Minute (IPM) Impak Per Minit 冲击数	3,000
Max Fastening Torque Maksimum Tenaga Pemutaran Pengancing 最快扭力	20N-m (177in.lbs.)
Dimensions (L x W) Dimensi 体积	Straight Style: 276x40mm (10-7/8"x1-9/16")
Dimensions (L x W x H) Dimensi 体积	Pistol Style: 213x40x131mm (8-3/8"x1-9/16"x5-1/8")
Net Weight Berat Bersih 淨重	0.53 - 0.54kg (1.2lbs)
Work Amount (approx.) Jumlah Kerja 工作量	232 pcs with BL7010 Wood screw ø3.1x25mm (Melapi White Wood)

DF012DSE

RM 885

Cordless Driver Drill

Gerudi Pemutar Skru Tanpa Kord
充电式螺丝起子电钻



- 2-Speed design for high or low torque applications



Standard Equipment: Phillips Bit 2pcs

- SE: 1x Standard Charger, 2x 1.5Ah Battery



Capacity Kapasiti 能力	Steel: 5mm (3/16") Wood: 6mm (1/4")
No Load Speed (RPM) Kelajuan Tanpa Beban 回转速数	High: 650 Low: 200
Max Fastening Torque Maksimum Tenaga Pemutaran Pengancing 最快扭力	Hard: 5.6N-m (50in.lbs.) Soft: 3.6N-m (32in.lbs.)
Max Lock Torque Pemutaran Tenaga Maksimum 最大扭力	8.0N-m (71in.lbs.)
Dimensions (L x W x H) Dimensi 体积	Pistol Style: 218x44x142mm (8-5/8"x1-3/4"x5-5/8")
Dimensions (L x W) Dimensi 体积	Straight Style: 273x44mm (10-3/4"x1-3/4")
Net Weight Berat Bersih 淨重	0.53kg (1.2lbs.)
Work Amount (approx.) Jumlah Kerja 工作量	350 pcs with BL7010 Wood screw ø3.8x25mm (Melapi Drove Wood)

* All list price shown are for reference only (exclude SST).

* Semua harga yang ditunjukkan adalah untuk rujukan sahaja (tidak termasuk SST). 所有显示的建议零售价仅供参考 (不包括SST)。

Cordless
Tanpa Kord 充电式

LED Flashlight
Lampu Suluh LED
LED 闪光灯

Vacuum Cleaner
Penyedut Vakum
吸尘器

Drilling / Fastening
Gergaji / Pengikat
电钻 / 螺丝

Impact Drilling / Demolition
Gergaji / Pemisah
电钻 / 电锤

Cutting
Pemotong
切割机

Grinding / Sanding
Pengisar / Poles
磨床 / 砂纸

Sawing
Gergaji
电锯

Planing / Routing
Pengisar / Tengam
刨床 / 铣床

Others
Lain-lain
其他

Outdoor Power Equipment
Alatan Kerja Luar
户外工具

Makita
MAKITA

3.6V

Li-ion Ah 1.5



DF001DW **Li-ion** 3.6V In-Line Cordless Screwdriver

Pemutar Skru Tanpa Kord Yang Tahan Lasak 充电式螺丝起子机

Comes with 81pcs assortment and Charger

Termasuk 81 bit dan pengecas | 81支配件与充电器套装

Drive type

Phillips (PH)	PZ	Hex (H)
T	Slotted (SL)	

C-form 25mm Screw bit

- PZ : 0, 1, 2, 3 (3pc each)
- Hex : 2, 2.5, 3, 4, 5, 6 (2pc each)
- T : 10, 15, 20, 25, 27, 30, 40 (3pc each)
- SL : 0.5x3, 0.5x4, 0.6x4.5, 0.8x5.5, 1.0x5.5, 1.2x6.5 (2pc each)
- PH : 0, 1, 2 (3pc each), 3 (2pc each)

E-form 50mm Screw bit

- T : 20, 25, 30 (1pc each)
- PH : 1, 2, 3 (1pc each)

E-form Socket Wrench

- 5, 6, 7, 8, 9, 10mm (1pc each)

E-form magnetic bit holder

- 60mm (1pc each)



Straight style
Dalam keadaan
melurus 直线式

Can be used as both of straight style and pistol style
Boleh digunakan dalam keadaan melurus atau pistol/ 可以用作直线式和手枪式两种方式

Pistol style
Dalam keadaan
pistol 手枪式

DF001DW

RM 353

In-Line Cordless Screwdriver

Pemutar Skru Tanpa Kord
充电式螺丝起子机



3.6V



- Convenient to used even in narrow space

Standard Equipment: Bit Set 81pcs, AC Adaptor, USB Cable



Fastening Capacities

Kapasiti Pengancing 最大紧固能力

Wood Screw: $\phi 3.8 \times 32\text{mm}$
(1/8"x1-1/4")

No Load Speed (RPM)

Kelajuan Tanpa Beban 无负荷转速

220

Max Fastening Torque

Maksimum Tenaga Pemutaran Pengancing 最大扭矩

Hard: 4.0N-m (35in.lbs.)

Soft: 3.0N-m (27in.lbs.)

Max Lock Torque

Maksimum Pengunci Tenaga Pemutaran 最大扭矩

6.0N-m (53 in.lbs.)

Charging Time (hours)

Masa Pengecasan 充电时间

3 - 5

Dimensions (L x W x H)

Dimensi 体积

Straight Style: 287x47x51mm

(11-1/4"x1-7/8"x2")

Pistol Style: 205x47x51mm

(8-1/8"x1-7/8"x2")

0.36kg (0.8 lbs.)

Net Weight

Keberatan 净重

Work Amount (approx.)

Jumlah Kerja 工作量

200 pcs

Wood Screw $\phi 3.8 \times 25\text{mm}$ (SPF plate)

Cordless
Tanpa Kord Yang Tahan Lasak

LED Flashlight
Lampu Suhu LED
LEDMENYALIT

Vacuum Cleaner
Penyedut Vakuum
吸尘器

Drilling / Fastening
Ganda / Pengasah
电钻 / 磨钻

Impact Drilling / Demolition
Ganda / Pemecah
电钻 / 电锤

Cutting
Pemotong
切割机

Grinding / Sanding
Pengisar / Pasir
磨刀 / 磨粉

Sawing
Gergaji
电锯

Planing / Routing
Penghalus / Tumpang
刨平 / 刨花

Others
Lain-lain
其他

Outdoor Power Equipment
Alatan Kerja Luar
户外动力设备

Makita
19157

* All list price shown are for reference only (exclude SST).

* Semua harga yang ditunjukkan adalah untuk rujukan sahaja (tidak termasuk SST). 所有显示的建议零售价仅供参考 (不包括SST)。

36V

Li-ion Ah 12 | 2.6 | 2.2



BHR262RB3 26mm (1")
RM 2,697

442

Cordless Combination Hammer
Tukul Kombinasi Tanpa Kord
充电式冲击钻锤



- 3-Mode operation for Rotation Only, Hammering with Rotation or Hammering Only

Standard Equipment: Depth Gauge, Side Grip, Bit Grease (194683-7), Cleaning Cloth, Tool Bag

- RB3: 1x 18V Rapid Charger, 3x 18V 3.0Ah Battery, 1x Battery Converter (BCV03)



Sementara stok masih ada 售完即止
WHILE STOCK LAST



Impact Energy Kekuatan Impak 单次最大冲击力	2.5J
Capacity Kapasiti 能力	Concrete: 26mm (1") Steel: 13mm (1/2") Wood: 32mm (1-1/4")
Impacts Per Minute (IPM) Impak Per Minit 冲击数	0 - 4,800
No Load Speed (RPM) Kelajuan Tanpa Beban 回转数	0 - 1,200
Dimensions (L x W x H) Dimensi 体积	363x104x235 mm (14-1/4"x4-1/8"x9-1/4")
Net Weight Berat Bersih 净重	4.6 - 5.1kg (10.2 - 11.2lbs.)

BUC250RD 250mm (10")
RM 3,822

442

Cordless Chain Saw
Gergaji Rantai Tanpa Kord
充电式链锯



- Low noise level and zero emissions for operator comfort

Standard Equipment: Guide Bar, Guide Bar Cover, Saw Chain, Chain Oil, Chain File (744003-1)

- RD: 1x 36V Rapid Charger (DC36RA), 1x 36V 2.6Ah Battery (BL3626)



Sementara stok masih ada 售完即止
WHILE STOCK LAST



Guide Bar Length Panjang Batang Gergaji 切割长度	250mm (10")
Chain Pitch Kerapatan Rantai 链条齿距	3/8" or 1/4"
Chain Oil Tank Volume Tangki Minyak Pelincir 链油箱	85mL (2.9US oz)
Dimensions (L x W x H) Dimensi 体积	576x239x200mm (22-3/4"x9-3/8"x7-7/8")
Net Weight Keberatan 净重	4.5kg (9.9lbs.)

BUH550RD | **BUH550Z** | **UH550DWB** 550mm (21-5/8")
RM 3,370 | RM 1,557 | RM 3,113

442

Cordless Hedge Trimmer
Pemangkas Tanaman Pagar Tanpa Kord
充电式篱笆修剪机



- 5-Position rotating rear handle for increased comfort during vertical and angle trimming

Standard Equipment: Blade Cover

- RD: 1x 36V Rapid Charger (DC36RA), 1x 36V 2.6Ah Battery (BL3626)
- DWB: 1x 36V Standard Charger (DC36WA), 1x 36V 2.2Ah Battery (BL3622A)
- Z: Without Charger & Battery



Sementara stok masih ada 售完即止
WHILE STOCK LAST



Blade Length Panjang bilah 刀片长度	550mm (21-5/8")
Strokes Per Minute (SPM) Kelajuan Strok 冲程速度	2,000 - 3,600
Tooth Spacing Selang Gigi 牙齿间隔	36mm (1-7/16")
Dimensions (L x W x H) Dimensi 体积	1,070x220x190mm (42"x8-5/8"x7-1/2")
Net Weight Keberatan 净重	5.1kg (11.2lbs.)

* All list price shown are for reference only (exclude SST).

* Semua harga yang ditunjukkan adalah untuk rujukan sahaja (tidak termasuk SST). 所有显示的建议零售价仅供参考 (不包括SST)。



BUH650RD | BUH650Z | UH650DWB 650mm (25-1/2") 442mm

RM 3,352 | RM 1,732 | RM 3,095
Cordless Hedge Trimmer
 Pemangkas Tanaman Pagar Tanpa Kord
 充电式篱笆修剪机



- 5-Position rotating rear handle for increased comfort during vertical and angle trimming

Standard Equipment: Blade Cover

- RD: 1x 36V Rapid Charger (DC36RA), 1x 36V 2.6Ah Battery (BL3626)
- DWB: 1x 36V Standard Charger (DC36WA), 1x 36V 2.2Ah Battery (BL3622A)
- Z: Without Charger & Battery



Blade Length Panjang bilah 刀片长度	650mm (25-1/2")
Strokes Per Minute (SPM) Kelajuan Strok 冲程速度	2,000 - 3,600
Tooth Spacing Selang Gigi 牙齿间隔	36mm (1-7/16")
Dimensions (L x W x H) Dimensi 体积	1,150x220x190mm (45-1/4"x8-5/8"x7-1/2")
Net Weight Keberatan 净重	5.2kg (11.5lbs.)

BUN490RD RM 5,998

Cordless Pole Hedge Trimmer
 Pemangkas Tanaman Pagar Tinggi Tanpa Kord
 充电式高枝篱笆修剪机



- Can be folded in the 180° position for easy transport and storage

Standard Equipment: Band Assembly, Wrench, Accessory Bag

- RD: 1x 36V Rapid Charger (DC36RA), 1x 36V 2.6Ah Battery (BL3626)



Strokes Per Minute (SPM) Kelajuan Strok 冲程速度	High: 0 - 4,000 Low: 0 - 2,800
Tooth Spacing Selang Gigi 牙齿间隔	35mm (1-3/8")
Dimensions (L x W x H) Dimensi 体积	2,595x226x211mm (100-3/16"x8-7/8"x8-5/16")
Net Weight Keberatan 净重	6.9kg (15.2 - 15.3lbs.)

BBC231URDE | BBC231UZ | BC231UDWBE RM 8,812 | RM 3,542 | RM 8,553

Cordless Brushcutter
 Pemotong Rumput Tanpa Kord
 充电式割草机



- Low noise level and zero emissions for operator comfort

Standard Equipment: Blade, Guard, Shoulder Harness with Double Shoulder Strap, Wrenches

- RDE: 1x 36V Rapid Charger (DC36RA), 2x 36V 2.6Ah Battery (BL3626)
- WBE: 1x 36V Standard Charger (DC36WA), 2x 36V 2.2Ah Battery (BL3622A)
- Z: Without Charger & Battery



No Load Speed (RPM) Kelajuan Tanpa Beban 回转数	High: 0-7,300 Low: 0-5,300
Spindle Size Saiz Spindel 主轴尺寸	M10 x 1.25LH
Dimensions (L x W x H) Dimensi 体积	1,880x620x490mm (74"x24-3/8"x19-1/4")
Net Weight Keberatan 净重	7.1kg (15.7lbs.)

BBC300LRDE RM 8,297

Cordless String Trimmer
 Pemotong Rumput Tanpa Kord
 充电式割草机



- Low noise level and zero emissions for operator comfort

Standard Equipment: Nylon Cutting Head, Guard, Band Assembly, Wrenches, Accessory Bag

- RDE: 1x 36V Rapid Charger (DC36RA), 2x 36V 2.6Ah Battery (BL3626)



No Load Speed (RPM) Kelajuan Tanpa Beban 回转数	High: 0 - 6,600 Low: 0 - 4,900
Spindle Size Saiz Spindel 主轴尺寸	M10 x 1.25LH
Dimensions (L x W x H) Dimensi 体积	1,850x340x325mm (73"x13-3/8"x12-3/4")
Net Weight Keberatan 净重	5.9kg (13lbs.)

BML360Z (STEXBML360) RM 399.10

Cordless Fluorescent Light
 Lampu Suluh Tanpa Kord
 充电式工作灯

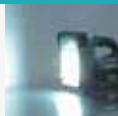

- Wide and bright illumination

- Z: Without Charger & Battery



Dimensions (L x W x H) Dimensi 体积	283x128x203mm (11-1/8"x5"x8")
Net Weight Berat Bersih 净重	2.3kg (5.1lbs.)

* All list price shown are for reference only (exclude SST).

* Semua harga yang ditunjukkan adalah untuk rujukan sahaja (tidak termasuk SST). 所有显示的建议零售价仅供参考 (不包括SST)。

Cordless
Tangan Kordless

LED Flashlight
Lampu Suluh LED
LEDMOTORT

Vacuum Cleaner
Penyedut Vakuum
BL3626

Drilling / Fastening
Gergaji / Pasak
BL3626

Impact Drilling / Demolition
Gergaji / Pasak
BL3626

Cutting
Pemotong
BL3626

Grinding / Sanding
Pergasi / Pasak
BL3626

Sawing
Gergaji
BL3626

Planing / Routing
Pergasi / Pasak
BL3626

Others
Lain-lain
BL3626

Outdoor Power Equipment
Alatan Kerja Luar
BL3626

Thakita
INT

14.4V

12V

9.6V



DTL062Z 9.5mm (3/8")
RM 1,218

Cordless Angle Impact Wrench
Perengkuh Impak Sudut Tanpa Kord
充电式角向冲击套筒扳手



14.4V



Standard Equipment: Belt Clip

• Z: Without Charger & Battery



Fastening Capacities
Kapasiti 能力

Standard Bolt:
M4 - M12 (5/32" - 1/2")
High Strength Bolt:
M4 - M8 (5/32" - 5/16")
9.5mm (3/8")

Square Drive

Skrü Persegi 方形螺桿

No Load Speed (RPM)

Kelajuan Tanpa Beban 回轉數

0 - 2,000

Impacts Per Minute (IPM)

Impak Per Minit 衝擊數

0 - 3,000

Max Fastening Torque

Pemutaran Tenaga Maksimum 最大扭力

60N-m

Dimensions (L x W x H)

Dimensi 体积

387x78x97mm
(15-1/4"x3-1/16"x3-13/16")

Net Weight

Berat Bersih 淨重

1.4 - 1.8kg (3.0 - 4.1lbs.)

DTW152Z 12.7mm (1/2")
RM 1,205

Cordless Impact Wrench
Perengkuh Impak Tanpa Kord
充电式冲击套筒扳手



14.4V



WHILE STOCK LAST

Standard Equipment: Belt Clip

• Z: Without Charger & Battery



Fastening Capacities
Kapasiti 能力

Standard Bolt:
M8 - M16 (5/16" - 5/8")
High Strength Bolt:
M8 - M12 (5/16" - 1/2")
12.7 mm (1/2")

Square Drive

Skrü Persegi 方形螺桿

No Load Speed (RPM)

Kelajuan Tanpa Beban 回轉數

0 - 2,400

Impacts Per Minute (IPM)

Impak Per Minit 衝擊數

0 - 3,200

Max Fastening Torque

Pemutaran Tenaga Maksimum 最大扭力

200N-m (150ft.lbs.)

Dimensions (L x W x H)

Dimensi 体积

158x79x234mm
(6-1/4"x3-1/8"x9-1/4")

Net Weight

Berat Bersih 淨重

1.3 - 1.5kg (2.8 - 3.4lbs.)

6271DWE 10mm (3/8")
RM 745

Cordless Driver Drill
Gerudi Pemutar Skru Tanpa Kord
充电式螺丝起子电钻



12V

Ni-Cd Battery



• All metal gear construction ensures high transmission durability

Standard Equipment: (+)(-) Bit

• WE: 1x Standard Charger, 2x 1.3Ah Ni-Cd Battery



Capacity

Kapasiti 能力

Steel: 10mm (3/8")
Wood: 21mm (13/16")

No Load Speed (RPM)

Kelajuan Tanpa Beban 回轉數

High: 0-1,300

Low: 0-400

Max Fastening Torque

Maksimum Tenaga Pemutaran Pengancing 最快扭力

Hard: 30N-m / **Soft:** 18N-m

Dimensions (L x W x H)

Dimensi 体积

192x95x240mm
(7-9/16"x3-3/4"x9-1/2")

Net Weight

Berat Bersih 淨重

1.5kg (3.4lbs.)

4190DW 80mm (3-1/8")
RM 1,765

Cordless Cutter
Pemotong Tanpa Wayar
充电式切割机



9.6V

Ni-Cd Battery



• Fast and easy glass and ceramic tile cutting

Standard Equipment: Diamond Wheel (792296-4), Hex Wrench

• W: 1x Standard Charger, 1x 1.3Ah Ni-Cd Battery

Blade Diameter

Diameter Bilah 锯片直径

80mm (3-1/8")

Max Cutting Capacity

Kapasiti Pemotongan Maksimum 最大切割能力

90°: 18mm (11/16")
45°: 16mm (5/8")

No Load Speed (RPM)

Kelajuan Tanpa Beban 回轉數

1,000

Overall Length

Dimensi 体积

313mm (12-3/8")

Net Weight

Berat Bersih 淨重

1.9kg (4.2lbs.)

* All list price shown are for reference only (exclude SST).

* Semua harga yang ditunjukkan adalah untuk rujukan sahaja (tidak termasuk SST). 所有显示的建议零售价仅供参考 (不包括SST)。

Cordless
Tanpa Kord / 充电式

LED Flashlight
Lampu Suluh LED
LED 手电筒

Vacuum Cleaner
Penyedut Vakuum
吸尘器

Drilling / Fastening
Draib / Pemegang
钻孔 / 紧固

Impact Drilling / Demolition
Draib / Pemecah
冲击钻孔 / 拆除加工

Cutting
Pemotong
切割

Grinding / Sanding
Pengisar / Hais
磨削 / 打磨

Sawing
Gergaji
锯切

Planing / Routing
Pengayam / Pengangam
刨平 / 开槽

Others
Lain-lain
其他

Outdoor Power Equipment
Alatan Kuasa Luar
户外动力设备

Makita
1915



Cordless Coffee Maker

Mesin Kopi Tanpa Kord 充电式咖啡机



Job Site Radio

Radio Tanpa Kord 充电式收音机



Cordless Fan

Kipas Tanpa Kord 充电式风扇



Cordless
Tanpa Kord 充电式

LED Flashlight
Lampu Sinar LED
LEDFLASH

Vacuum Cleaner
Pembersih Vakuum
VACUUM

Drilling / Fastening
Ganda / Penggulat
DRILL / FASTEN

Impact Drilling / Demolition
Ganda / Perusak
IMPACT DRILL / DEMOLITION

Cutting
Pemotong
CUT

Grinding / Sanding
Pergilas / Pasir
GRIND / SAND

Sawing
Gergaji
SAW

Planing / Routing
Pergilas / Tergulung
PLANER / ROUTER

Others
Lain-lain
OTHERS

Outdoor Power Equipment
Alat-alat Tenaga Listrik
OUTDOOR POWER EQUIPMENT

Makita
INTL

18V

LXT

12V_{max}

CXT

Li-ion Ah 6.0 5.0 4.0 3.0 2.0 1.5

7 Selectable Sound Modes

7 Mod bunyi yang boleh dipilih 7种可选声音模式

Equalizer	LED		
FLAT	White	CLASSIC	Brown
		POP	Pink
JAZZ	Blue	NEWS	Yellow
		MY EQ	Green
ROCK	Red		



Carry handle with built in FM antenna

Carry handle dengan terbita dalam antenna FM
内置手柄调频天线



Bluetooth

USB output port allows for charging a mobile device

• Type A USB socket for DC5V / 2.4A USB output

AUX-IN jack

Jack AUX-IN AUX-IN插孔

DMR114 18V / 12V_{max} / AC
Price TBA

Job Site Radio
Radio Tanpa Kord
充电式收音机



• Equipped with equalizer for 7 selectable sound modes

Standard Equipment: AC Adaptor

• Without Charger & Battery

Bluetooth

Frequency Band Julat Kekerapan 频率范围	FM: 87.5 - 108MHz AM: 522 - 1,710kHz
Speaker Size Saiz Speaker 喇叭尺寸	Sides: Ø63.5mm x2 Bottom: Ø101.6mm
Bluetooth Bluetooth 蓝牙连接	Version: 5.0 Profile: A2DP SCMS-T AVRCP Supported Codec: SBC / AAC Max Transmission Range: (Optimum): 10m (33ft) (Possible): 30m (98ft) Transmission Power Class: 2 Compatible Bluetooth Profile: A2DP

Dimensions (L x W x H) Dimensi 体积	268x164x295mm (10-1/2"x6-1/2"x11-5/8")
Net Weight Berat Bersih 净重	4.9 - 5.6kg (10.8 - 12.3lbs.)
Continuous Usage Time (approx.) Masa Penggunaan Berterusan 连续使用时间	17 hrs with BL1850B

DMR203 18V / 12V_{max} / AC
Price TBA

Cordless Job Site Speaker
Pembesar Suara Tanpa Kord
充电式音箱



• Equipped with equalizer for 7 selectable sound modes

Standard Equipment: AC Adaptor

• Without Charger & Battery

Bluetooth

Speaker Size Saiz Speaker 喇叭尺寸	Sides: Ø63.5mm x2 Bottom: Ø101.6mm
Bluetooth Bluetooth 蓝牙连接	Version: 5.0 Profile: A2DP SCMS-T AVRCP Supported Codec: SBC Max Transmission Range: 10m (33ft) Max Transmission Range (Possible): 30m (100ft)

Dimensions (L x W x H) Dimensi 体积	217x206x199mm (8-1/2"x8-1/8"x7-7/8")
Net Weight Berat Bersih 净重	2.7 - 3.4kg (6.0 - 7.5lbs.)
Continuous Usage Time (approx.) Masa Penggunaan Berterusan 连续使用时间	29 hrs with BL1850B

Product Comparison List

Senarai Perbandingan Produk 产品对比表

	18V	12V _{max}
Run time (hrs)	Up to: 17 with BL1850B	Up to: 26 Bluetooth: with BL1850B
Bluetooth	●	●
Net weight	5.1 - 5.6kg (11.3 - 12.3lbs.)	2.7 - 3.4kg (6.0 - 7.5lbs)

* All list price shown are for reference only (exclude SST).

* Semua harga yang ditunjukkan adalah untuk rujukan sahaja (tidak termasuk SST). 所有显示的建议零售价仅供参考 (不包括SST)。

Cordless
Tampal Kord Tanpa Kord

LED Flashlight
Lampu Suluh LED
LED 闪光灯

Vacuum Cleaner
Penyedut Vakuum
吸尘器

Drilling / Fastening
Draut / Pengikat
电钻 / 螺絲

Impact Drilling / Demolition
Draut / Pemusnah
电钻 / 电锤

Cutting
Pemotong
电锯

Grinding / Sanding
Pengisar / Hais
磨床 / 砂纸

Sawing
Gergaji
电锯

Planing / Routing
Pegaram / Pengam
刨床 / 铣床

Others
Lain-lain
其他

Outdoor Power Equipment
Alatan Kuasa Luar
户外动力工具

Makita
100

18V

LXT

Li-ion Ah 6.0 | 5.0 | 4.0 | 3.0 | 2.0 | 1.5

Cordless Fan

Kipas Tanpa Kord 充电式风扇

Max Air Speed
Kelajuan angin maksimum
最大风速
190m/min

*Masa Penggunaan Berterusan
连续使用时间
Continuous Usage Time
with BL1850B x1
(High Speed)
360min
(approx.)

* Continuous Usage Time/ Work Amount:
Actual performance may vary based on application.
Masa Penggunaan Berterusan/ Jumlah Kerja: Prestasi sebenar
mungkin berbeza mengikut aplikasi.
连续使用时间/ 工作量: 实际表现可能因应用而异。



Adjustable fan head angle

Sudut kepala kipas boleh laras 可调整风扇头角度



Up 90°, Down 45°
Left/ Right 90°

Automatic swing fan

Left/ Right 45°

Kipas pusing automatik Kiri / Kanan 45°
自动摇摆左/右45°



DCF203Z 18V / 14.4V
RM 1,290

Cordless Fan
Kipas Tanpa Kord
充电式风扇



• Cordless automatic swing fan



• Z : Without Charger & Battery



Max Air Velocity Kelajuan Angin Maksimum 最大风速	High: 190m/min Med: 150m/min Low: 120m/min
Air Flow Aliran Udara 空气流量	High: 8.2m³/min Med: 6.5m³/min Low: 5.2m³/min
Dimensions (L x W x H) Dimensi 体积	140x333x447mm (5-1/2"x13"x16-1/2")
Net Weight Berat Bersih 净重	1.9 - 2.6kg (4.2 - 5.6lbs.)
Continuous Usage Time (approx.) Masa Penggunaan Berterusan 连续使用时间	Low: 1,010 min Med: 650 min High: 410 min with BL1860B

DCF102Z 18V / 14.4V
RM 678

Cordless Fan
Kipas Tanpa Kord
充电式风扇



• Automatically Swings 45° L/R

• Z : Without Charger & Battery



Air Flow Aliran Udara 空气流量	High: 4.6L/min Med: 3.8L/min Low: 3.0L/min
Dimensions (L x W x H) Dimensi 体积	185x272x284mm (7-1/4"x10-3/10"x11-1/8")
Net Weight Berat Bersih 净重	1.3 - 2.0kg (2.9 - 4.4lbs.)
Continuous Usage Time (approx.) Masa Penggunaan Berterusan 连续使用时间	Low: 1,270 min Mid: 705 min High: 575 min with BL1860B

DCF201Z 18V
RM 545

Cordless Fan
Kipas Tanpa Kord
充电式风扇



• Strong enough to create a comfortable work environment under hot weather

• Z : Without Charger & Battery



Dimensions (L x W x H) Dimensi 体积	263x330x523mm (10-3/8"x13"x20-5/8")
Net Weight Berat Bersih 净重	2.5 - 2.9kg (5.5 - 6.3lbs.)
Continuous Usage Time (approx.) Masa Penggunaan Berterusan 连续使用时间	Low: 330min High: 165min with BL1850B

* All list price shown are for reference only (exclude SST).

* Semua harga yang ditunjukkan adalah untuk rujukan sahaja (tidak termasuk SST). 所有显示的建议零售价仅供参考 (不包括SST)。

Cordless
Tools and Power

LED Flashlight
Lampu Sinar LED
LED手电筒

Vacuum Cleaner
Penyedut Vakuum
吸尘器

Drilling / Fastening
Gruat / Pasut
电钻 / 螺絲

Impact Drilling / Demolition
Gruat / Pencah
电钻 / 电锤

Cutting
Pemotong
切割机

Grinding / Sanding
Pergasil / Pasut
砂磨 / 磨

Sawing
Gajuh
电锯

Planing / Routing
Pegayaan / Terguan
刨 / 铣

Others
Lain-lain
其他

Outdoor Power Equipment
Alatan Kerja Luar
户外设备

Makita
19157



CF101DZ 12Vmax
RM 643

Cordless Fan
Kipas Tanpa Kord
充电式风扇



- Automatically Swings 45° L/R

- Z: Without Charger & Battery



Air Flow Aliran Udara 空气流量	High: 4.6L/min Med: 3.8L/min Low: 3.0L/min
Dimensions (L x W x H) Dimensi 体积	185x260x284mm (7-1/4"x10-1/4"x11-1/8")
Net Weight Berat Bersih 净重	1.3 - 1.7kg (2.8 - 3.8lbs.)
Continuous Usage Time (approx.) Masa Penggunaan Berterusan 连续使用时间	Low - 315min Med - 190min High - 135min with BL1021B

CF100DZ 12Vmax / AC
RM 487

Cordless Fan
Kipas Tanpa Kord
充电式风扇



- Compact Size Allows Installation Even in Small Spaces

Standard Equipment: AC Adaptor

- Z: Without Charger & Battery



Dimensions (L x W x H) Dimensi 体积	148x260x252mm (5-7/8"x10-1/4"x9-7/8")
Net Weight Berat Bersih 净重	1.2 - 1.4kg (2.7 - 3.1lbs)
Continuous Usage Time (approx.) Masa Penggunaan Berterusan 连续使用时间	Low - 315min Med - 190min High - 135min with BL1021B

Product Comparison List 18V 12Vmax

Senarai Perbandingan Produk 产品对比表

	DCF203	DCF102	DCF201	CF101D	CF100D
Run time (min.)	High: 360 Med: 580 Low: 960 with BL1850B	High: 480 Med: 585 Low: 1060 with BL1850B	High: 180 Low: 400 with BL1850B	High: 630 Med: 380 Low: 275 with BL1041B	High: 275 Med: 380 Low: 630 with BL1041B
Max air speed (m/ min)	190	180	120	180	180
Fan size (mm)	235	180	230	180	180
Automatic swing fan	●	●	●	●	●
Net weight	1.9 - 2.6 kg (4.2 - 5.6 lbs.)	1.3 - 2.0 kg (2.9 - 4.4 lbs.)	2.2 - 2.7 kg (4.9 - 5.9 lbs.)	1.3 - 1.7 kg (2.8 - 3.8 lbs.)	1.2 - 1.4 kg (2.7 - 3.1 lbs.)

ADP05 (AUBADP05) 18V
RM 161

Adapter for USB
Penyesuai untuk USB
USB适配器



- As a charger for smart phones

- Without Charger & Battery

USB Port Soket USB USB插口位置	2 (A type)
Dimensions (L x W x H) Dimensi 体积	102x72x43mm (4"x2-13/16"x1-11/16")
Net Weight Berat Bersih 净重	0.46 - 0.71kg (1.0 - 1.6lbs)
Work Amount (approx.) Jumlah Kerja 工作量	10times with BL1830B Charging Iphone 6S (1715 mA-h)

* All list price shown are for reference only (exclude SST).

* Semua harga yang ditunjukkan adalah untuk rujukan sahaja (tidak termasuk SST). 所有显示的建议零售价仅供参考 (不包括SST)。

Cordless Impact Tool
LED Flashlight Lampu Suluh LED
Vacuum Cleaner
Drilling / Fastening
Impact Drilling / Demolition
Cutting
Grinding / Sanding
Sawing
Planing / Routing
Others
Outdoor Power Equipment



18V**LXT****12Vmax****CXT****Li-ion** Ah 6.0 5.0 4.0 3.0 2.0 1.5**ADP06** (AUAADP06)
RM 162.20**ADP08** (AUAADP08) 12Vmax
RM 135.90**Adapter for USB**
Penyesuai untuk USB
USB适配器

ADP06



ADP08



• As a charger for smart phones

• Without Charger & Battery

Battery Bateri 电池	12Vmax 1.5Ah, 2.0Ah, 4.0Ah
USB Port Soket USB USB接口位置	1 (type A)
Devices Peralatan 设备	iOS & Android
Dimensions (L x W x H) Dimensi 体积	80x53x38mm ADP06 (3-1/8"x2-1/16"x1-1/2") 80x53x28mm ADP08 (3-1/8"x2-1/16"x1-1/8")
Net Weight Berat Bersih 净重	0.27 - 0.44kg (0.6 - 1.0lbs)
Work Amount (approx.) Jumlah Kerja 工作量	1.3time charges with BL1021B ADP06 Charging Iphone 7 (1960 mA-h) 1.5time charges with BL1021B ADP08 Charging Iphone 7 (1960 mA-h)

Cordless Coffee Maker

Mesin Kopi Tanpa Kord 充电式咖啡机

18V
LITHIUM-ION
18V Lithium-Ion
18V锂离子**12Vmax**
LITHIUM-ION
12V Lithium-Ion
12V锂离子**Capacity of Cup**Makita Cafe pod
120mL | Ground coffee (6.5g)
160mL**Water Tank Capacity**Kapasiti Tangki Air
水箱容量**240mL****Carry Handle**
for easy transportPemegang mudah dibawa
手柄便于携带**Dedicated Cup Capacity**
240mL**Makita genuine cafe pods**
are prepared 20pcs/box**Brazil**
Fragrant bitter &
deep flavor**Mocha**
Sweet scent &
mild taste**Kilimanjaro**
Aftertaste with bitter
sweet & sharpness**DCM501Z** 18V / 12Vmax
RM 830**Cordless Coffee Maker**
Mesin Kopi Tanpa Kord
充电式咖啡机

• Large tank capacity of 240 mL

Standard Equipment: Mug, Measuring Spoon

• Z : Without Charger & Battery

Water Tank Capacity Dimensi 体积	240mL
Compatible Cafe Pod Type Berat Bersih 净重	60mm
Dimensions (L x W x H) Masa Penggunaan Berterusan 连续使用时间	243x187x218mm (9-9/16"x7-3/8"x8-9/16")
Net Weight	1.9 - 2.2kg (4.1 - 4.8lbs.)
Continuous Usage Time (approx.)	4cups 160mL Coffee with BL1860B

* All list price shown are for reference only (exclude SST).

* Semua harga yang ditunjukkan adalah untuk rujukan sahaja (tidak termasuk SST). 所有显示的建议零售价仅供参考 (不包括SST).

Cordless
Targeted for ProfessionalsLED Flashlight
Lampu Sinar LED
LED照明灯Vacuum Cleaner
Penyedut Vakuum
吸尘器Drilling / Fastening
Guaht / Pasak
电钻 / 螺絲Impact Drilling / Demolition
Guaht / Penanggal
电钻 / 拆墙器Cutting
Pemotong
切割机Grinding / Sanding
Pergasil / Pasak
磨刀 / 磨粉Sawing
Guaht
电锯Planing / Routing
Pegayaan / Tanggapan
刨板 / 刨花Others
Lain-lain
其他Outdoor Power Equipment
Alatan Kuat Unit
户外动力设备**Makita**
19155



Li-ion Ah 6.0 5.0 4.0 3.0 2.0 1.5

Cordless Fan Jacket

Jaket Kipas Tanpa Kord 充电式风扇夹克



Max Air Flow
Aliran Udara Maksimum
最大空气流量
2.2m³/min
(Turbo Mode)

Model No.	Battery holder
DFJ201	
DFJ202 DFJ213 DFJ211 DFJ214 DFJ300 DFV210 DFJ311 FJ502D DFJ400 FJ203D DFJ411 FJ301D DFJ212 FJ401D	 Battery Holder Set Part No. 198732-2
DCV202 DCB200	 Battery Holder Set Part No. YL00000004
DCV202 CB100D	 Battery Holder Set Part No. YL00000003

Jacket Size

saiz Jaket 夹克尺寸



Fan Vest

	size (in cm)	S	M	L	XL	2XL	3XL
DFV210	Length	67	69	71	72	73	74
	Shoulder	43	45	47	49	51	53
	Chest	113	118	123	128	133	138
	Waist	107	112	117	122	127	132

Heated Vest

	size (in cm)	S	M	L	XL	2XL	3XL
DCV202	Length	72	73	74	75	76	77
	Shoulder	47.5	49.5	51.5	53.5	55.5	57.5
	Chest	114	120	126	132	138	144
	Waist	116	122	128	134	140	146

Fan Jacket

	size (in cm)	S	M	L	XL	2XL	3XL
DFJ212	Length	66	68	70	71	72	73
	Shoulder	44	46	48	50	52	54
	Sleeve*	87	90	93	95	97	99
	Chest	117	122	127	132	137	142
	Waist	111	116	121	126	131	136
DFJ213	Length	65	67	69	70	71	72
	Shoulder	47	49	51	53	55	57
	Sleeve	62	64	66	67	68	69
	Chest	117	122	127	132	137	142
DFJ214	Waist	103 ~ 111	108 ~ 116	113 ~ 121	118 ~ 126	123 ~ 131	128 ~ 136
	Length	68	70	72	73	74	75
	Shoulder	47	49	51	53	55	57
	Sleeve	62	64	66	67	68	69
DFJ211	Chest	117	122	127	132	137	142
	Waist	103 ~ 111	108 ~ 116	113 ~ 121	118 ~ 126	123 ~ 131	128 ~ 136
	Length	68	70	72	74	76	78
	Shoulder	56.5	59	61.5	64	66.5	69
DFJ311	Sleeve	58	60	62	64	66	68
	Chest	126	131	136	141	146	151
DFJ411	Waist	87 ~ 113	92 ~ 113	97 ~ 113	102 ~ 133	107 ~ 138	112 ~ 143

* All list price shown are for reference only (exclude SST).

* Semua harga yang ditunjukkan adalah untuk rujukan sahaja (tidak termasuk SST). 所有显示的建议零售价仅供参考 (不包括SST)。

Cordless
Tanpa Kord Tanpa Kord

LED Flashlight
Lampu Suluh LED
LED 手电筒

Vacuum Cleaner
Penyedut Vakuum
吸尘器

Drilling / Fastening
Draai / Pengikat
电钻 / 螺絲

Impact Drilling / Demolition
Draai / Persekit
电钻 / 电锤

Cutting
Pemotong
电锯

Grinding / Sanding
Pengisar / Habis
磨床 / 砂纸

Sawing
Gergaji
电锯

Planing / Routing
Pegangan / Tongkat
刨刀 / 刨花

Others
Lain-lain
其他

Outdoor Power Equipment
Alatan Kuasa Luar
户外动力设备

Makita
MAKITA



FJ502DZM | **FJ502DZL** | **FJ502DZLL** 18V / 12Vmax
 RM 1,278 | RM 1,278 | RM 1,278

Cordless Fan Jacket
 Jaket Kipas Tanpa Kord
 充电式风扇夹克

FJ502D
 ZM / ZL / ZLL



- Equipped with Two Flat Fan Units with BL Motor for Increased Comfort

• Without Charger & Battery



Air Flow Settings Tetapan Aliran Udara 空气流量设置	Turbo High Medium Low
Air Flow Aliran Udara 空气流量	Turbo: 2.2m ³ /min High: 2.1m ³ /min Med: 1.7m ³ /min Low: 1.5m ³ /min
Size Saiz 尺寸	M L LL

DFJ211ZM | **DFJ211ZL** | **DFJ211ZXL** 18V / 12Vmax
 RM 762 | RM 762 | RM 762

Cordless Fan Jacket
 Jaket Kipas Tanpa Kord
 充电式风扇夹克



DFJ211
 ZM / ZL / ZXL



- Equipped with Two Flat Fan Units with BL Motor for Increased Comfort

• Without Charger & Battery



Air Flow Settings Tetapan Aliran Udara 空气流量设置	Turbo High Medium Low
Air Flow Aliran Udara 空气流量	Turbo: 2.2m ³ /min High: 2.1m ³ /min Med: 1.7m ³ /min Low: 1.5m ³ /min
Size Saiz 尺寸	M L XL
Pockets Poket 口袋	5
Net Weight Berat Bersih 净重	0.41kg (0.9lbs.)
Continuous Usage Time (approx.) Masa Penggunaan Berterusan 连续使用时间	Low: 29 hrs Medium: 21 hrs High: 12 hrs with BL1850B

Polyester For general work

Untuk kerja am | 用于一般工作
 • Superior moisture permeability and water repellent

DFJ311ZM | **DFJ311ZL** | **DFJ311ZXL** 18V / 12Vmax
 RM 800 | RM 800 | RM 800

Cordless Fan Jacket
 Jaket Kipas Tanpa Kord
 充电式风扇夹克



DFJ311
 ZM / ZL / ZXL



- Equipped with Two Flat Fan Units with BL Motor for Increased Comfort

• Without Charger & Battery



Air Flow Settings Tetapan Aliran Udara 空气流量设置	Turbo High Medium Low
Air Flow Aliran Udara 空气流量	Turbo: 2.2m ³ /min High: 2.1m ³ /min Med: 1.7m ³ /min Low: 1.5m ³ /min
Size Saiz 尺寸	M L XL
Pockets Poket 口袋	5
Net Weight Berat Bersih 净重	0.52kg (1.1lbs.)
Continuous Usage Time (approx.) Masa Penggunaan Berterusan 连续使用时间	Low: 29 hrs Medium: 21 hrs High: 12 hrs with BL1850B

Cotton For welding/ grinding work

Untuk kerja kimpalan/ pengisaran | 用于焊接/ 打磨工作
 • Strong in heat and sparks

DFJ411ZM | **DFJ411ZL** | **DFJ411ZXL** 18V / 12Vmax
 RM 965 | RM 965 | RM 965

Cordless Fan Jacket
 Jaket Kipas Tanpa Kord
 充电式风扇夹克



DFJ411
 ZM / ZL / ZXL



- Equipped with Two Flat Fan Units with BL Motor for Increased Comfort

• Without Charger & Battery



Air Flow Settings Tetapan Aliran Udara 空气流量设置	Turbo High Medium Low
Air Flow Aliran Udara 空气流量	Turbo: 2.2m ³ /min High: 2.1m ³ /min Med: 1.7m ³ /min Low: 1.5m ³ /min
Size Saiz 尺寸	M L XL
Pockets Poket 口袋	5
Net Weight Berat Bersih 净重	0.49kg (1.1lbs.)
Continuous Usage Time (approx.) Masa Penggunaan Berterusan 连续使用时间	Low: 29 hrs Medium: 21 hrs High: 12 hrs with BL1850B

Polyester + Titanium coating For outdoor work

Untuk kerja luaran | 用于户外工作
 • Reflective in ultraviolet rays and infrared rays

DFJ214ZM | **DFJ214ZL** | **DFJ214ZXL** 18V / 12Vmax
 RM 1,202 | RM 1,202 | RM 1,202

Cordless Fan Jacket
 Jaket Kipas Tanpa Kord
 充电式风扇夹克



DFJ214
 ZM / ZL / ZXL



- Equipped with Two Flat Fan Units with BL Motor for Increased Comfort

• Without Charger & Battery



Air Flow Settings Tetapan Aliran Udara 空气流量设置	Turbo High Medium Low
Air Flow Aliran Udara 空气流量	Turbo: 2.2m ³ /min High: 2.1m ³ /min Med: 1.7m ³ /min Low: 1.5m ³ /min
Size Saiz 尺寸	M L XL
Pockets Poket 口袋	5
Net Weight Berat Bersih 净重	0.54kg (1.2lbs.)
Continuous Usage Time (approx.) Masa Penggunaan Berterusan 连续使用时间	Low: 29 hrs Medium: 21 hrs High: 12 hrs with BL1850B

Polyester

• water repellency, antistatic fabric

* All list price shown are for reference only (exclude SST).

* Semua harga yang ditunjukkan adalah untuk rujukan sahaja (tidak termasuk SST). 所有显示的建议零售价仅供参考 (不包括SST)。

Cordless
Tanpa Kabel / 无线

LED Flashlight
Lampu Saku LED
LED手电筒

Vacuum Cleaner
Penyedut Vakuum
吸尘器

Drilling / Fastening
Gergaji / Pengikat
电钻 / 螺絲

Impact Drilling / Demolition
Gergaji / Penanggal
电钻 / 拆卸

Cutting / Finishing
Penerajang
切割机

Grinding / Sanding
Pengisar / Habis
打磨 / 磨光

Sawing / Cutting
Gergaji
锯切

Planing / Routing
Penghalus / Tangkapan
刨平 / 截断

Others
Lain-lain
其他

Outdoor Power Equipment
Alatan Kerja Luar
户外动力设备





DFJ212ZM | **DFJ212ZL** | **DFJ212ZXL** 18V / 12Vmax
 RM 1,072 | RM 1,072 | RM 1,072

Cordless Fan Jacket
 Jaket Kipas Tanpa Kord
 充电式风扇夹克



DFJ212
ZM / ZL / ZXL

- Equipped with Two Flat Fan Units with BL Motor for Increased Comfort

• Without Charger & Battery



Air Flow Settings Tetapan Aliran Udara 空气流量设置	Turbo High Medium Low
Air Flow Aliran Udara 空气流量	Turbo: 2.2m³/min High: 2.1m³/min Med: 1.7m³/min Low: 1.5m³/min
Size Saiz 尺寸	M L XL
Pockets Poket 口袋	5
Net Weight Berat Bersih 淨重	0.43kg (0.9lbs.)
Continuous Usage Time (approx.) Masa Penggunaan Berterusan 连续使用时间	Low: 29 hrs Medium : 21 hrs High: 12 hrs with BL1850B

Polyester

- High repellency fabric

DFJ213ZM | **DFJ213ZL** | **DFJ213ZXL** 18V / 12Vmax
 RM 1,017 | RM 1,017 | RM 1,017

Cordless Fan Jacket
 Jaket Kipas Tanpa Kord
 充电式风扇夹克



DFJ213
ZM / ZL / ZXL

- Equipped with Two Flat Fan Units with BL Motor for Increased Comfort

• Without Charger & Battery



Air Flow Settings Tetapan Aliran Udara 空气流量设置	Turbo High Medium Low
Air Flow Aliran Udara 空气流量	Turbo: 2.2m³/min High: 2.1m³/min Med: 1.7m³/min Low: 1.5m³/min
Size Saiz 尺寸	M L XL
Pockets Poket 口袋	5
Net Weight Berat Bersih 淨重	0.54kg (1.2lbs.)
Continuous Usage Time (approx.) Masa Penggunaan Berterusan 连续使用时间	Low: 29 hrs Medium : 21 hrs High: 12 hrs with BL1850B

Polyester

- Stretchable fabric

DFV210ZM | **DFV210ZL** | **DFV210ZXL** 18V / 12Vmax
 RM 873 | RM 873 | RM 873

Cordless Fan Vest
 Jaket Kipas Tanpa Kord
 充电式风扇背心



DFV210
ZM / ZL / ZXL

- Equipped with Two Flat Fan Units with BL Motor for Increased Comfort

• Without Charger & Battery



Air Flow Settings Tetapan Aliran Udara 空气流量设置	Turbo High Medium Low
Air Flow Aliran Udara 空气流量	Turbo: 2.2m³/min High: 2.1m³/min Med: 1.7m³/min Low: 1.5m³/min
Size Saiz 尺寸	M L XL
Pockets Poket 口袋	5
Net Weight Berat Bersih 淨重	0.38kg (0.8lbs.)
Continuous Usage Time (approx.) Masa Penggunaan Berterusan 连续使用时间	Low: 29 hrs Medium : 21 hrs High: 12 hrs with BL1850B

Polyester

- High repellency fabric

DFJ202ZL | **DFJ202ZXL** | **FJ203DZL** | **FJ203DZLL** 18V / 12Vmax
 RM 710 | RM 710 | RM 760 | RM 760

Cordless Fan Jacket
 Jaket Kipas Tanpa Kord
 充电式风扇夹克



SEKILAS SAKU, MESH ADA 售完即止
WHILE STOCK LAST

DFJ202
ZL / ZXL

FJ203
DZL / DZLL

- Powerful fan provides air flow to keep you cool

Standard Equipment: Fan Hook

• Without Charger & Battery



Air Flow Settings Tetapan Aliran Udara 空气流量设置	Turbo High Medium Low
Air Flow Aliran Udara 空气流量	Turbo: 1.4m³/min High: 1.2m³/min Med: 1.0m³/min Low: 0.8m³/min
Size Saiz 尺寸	L XL LL
Pockets Poket 口袋	5
Net weight Berat Bersih 淨重	1.5 - 1.9kg (3.3 - 4.1lbs)
Continuous Usage Time (approx.) Masa Penggunaan Berterusan 连续使用时间	Low: 28 hrs Medium : 20 hrs High: 11 hrs with BL1850B

Polyester For general work

Untuk kerja am | 用于一般工作

- Superior moisture permeability and water repellent

DFJ300ZXL | **FJ301DZM** | **FJ301DZL** | **FJ301DZLL** 18V / 12Vmax
 RM 745 | RM 797 | RM 797 | RM 797

Cordless Fan Jacket
 Jaket Kipas Tanpa Kord
 充电式风扇夹克



DFJ300
ZXL

FJ301
DZM / DZL / DZLL

- 100% cotton - hardly-burned, suitable for welding/ grinding

Standard Equipment: Fan Hook

• Without Charger & Battery



Air Flow Settings Tetapan Aliran Udara 空气流量设置	Turbo High Medium Low
Air Flow Aliran Udara 空气流量	Turbo: 1.4m³/min High: 1.2m³/min Med: 1.0m³/min Low: 0.8m³/min
Size Saiz 尺寸	DFJ300: XL FJ301: M L LL
Pockets Poket 口袋	5
Net weight Berat Bersih 淨重	1.5 - 1.9kg (3.3 - 4.1lbs)
Continuous Usage Time (approx.) Masa Penggunaan Berterusan 连续使用时间	Low: 29 hrs Medium : 21 hrs High: 12 hrs with BL1850B

Cotton For welding/ grinding work

Untuk kerja kimpalan/ pengisaran | 用于焊接/ 打磨工作

- Strong in heat and sparks

* All list price shown are for reference only (exclude SST).

* Semua harga yang ditunjukkan adalah untuk rujukan sahaja (tidak termasuk SST). 所有显示的建议零售价仅供参考 (不包括SST)。

Cordless
Targeted Tools
LED Flashlight
Lampu Suluh LED
LED BATTERY
Vacuum Cleaner
Penisih Vakuum
BL MOTOR
Drilling / Fastening
Dronji / Pengikat
DRILL / 鑽頭
Impact Drilling / Demolition
Dronji / Pemisah
DRILL / 鑽頭
Cutting
Pemotong
CUTTING
Grinding / Sanding
Pengisar / Poles
GRINDING / 磨頭
Sawing
Gergaji
SAWING
Planing / Routing
Pegaram / Tongkat
PLANING / 磨頭
Others
Lain-lain
OTHERS
Outdoor Power Equipment
Alatan Kuasa Luar
OUTDOOR POWER EQUIPMENT
Makita
MAKITA

18V

LXT

12Vmax

CXT

Li-ion Ah 6.0 | 5.0 | 4.0 | 3.0 | 2.0 | 1.5

DFJ400ZXL RM 848 | **FJ401DZL** RM 970 | **FJ401DZLL** RM 970 | **FJ401DZ3L** RM 970 18V / 12Vmax

Cordless Fan Jacket
Jaket Kipas Tanpa Kord
充电式风扇夹克



- Heavy-duty shoulder pad lightens the burden on a shoulder and prevents torn while carrying reinforcing bars



DFJ400 ZXL

FJ401 DZL / DZLL / DZ3L

Standard Equipment: Fan Hook

- Without Charger & Battery



Air Flow Settings Tetapan Aliran Udara 空气流量设置	Turbo High Medium Low
Air Flow Aliran Udara 空气流量	Turbo: 1.4m³/min High: 1.2m³/min Med: 1.0m³/min Low: 0.8m³/min
Size Saiz 尺寸	DFJ400: XL FJ401: L LL 3L
Pockets Poket 口袋	5
Net weight Berat Bersih 淨重	1.5 - 1.9kg (3.3 - 4.1lbs)
Continuous Usage Time (approx.) Masa Penggunaan Berterusan 连续使用时间	Low: 28 hrs Medium: 20 hrs High: 11 hrs with BL1850B

Polyester + Titanium processing For outdoor work
Untuk kerja luaran | 用于户外工作

- Reflective in ultraviolet rays and infrared rays

DFJ201ZM RM 710 | **DFJ201ZL** RM 710 | **DFJ201ZXL** RM 710 18V

Cordless Fan Jacket
Jaket Kipas Tanpa Kord
充电式风扇夹克



- Stay cool in hot harsh job site environments



DFJ201 ZM / ZL / ZXL

Standard Equipment: Battery Holder

- Without Charger & Battery



Air Flow Settings Tetapan Aliran Udara 空气流量设置	Turbo High Medium Low
Air Flow Aliran Udara 空气流量	Turbo: 1.4m³/min High: 1.2m³/min Med: 1.0m³/min Low: 0.8m³/min
Size Saiz 尺寸	M L XL
Pockets Poket 口袋	3
Net weight Berat Bersih 淨重	660g (1.5lbs)
Continuous Usage Time (approx.) Masa Penggunaan Berterusan 连续使用时间	Low: 28 hrs Medium: 20 hrs High: 11 hrs with BL1850B

Polyester For general work
Untuk kerja am | 用于一般工作

- Superior moisture permeability and water repellent

Cordless Heated Vest

Ves Pemanas Tanpa Kord 充电式发热背心



Heating Effects

Fungsi Pemanasan 发热效果

When wearing in a minus 5°C environment (in High mode)

Apabila memakai dalam persekitaran suhu 5°C (dalam mod Tinggi) 在零下5°C的环境中佩戴 (高级模式)

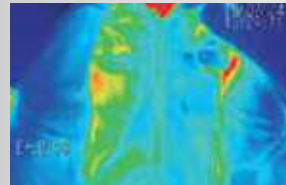

when switch is off

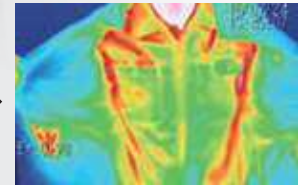

about 15 minutes after switch-on

DCV202YXL 18V RM 940

Cordless Heated Vest
Ves Pemanas Tanpa Kord
充电式发热背心



- Stay warm in cold harsh job site environments



DCV202 ZXL

- Without Charger & Battery

Heat Zones Tetapan Aliran Udara 發熱區域	Total: 4 Chest: 2 Back: 2
Heat Settings Aliran Udara 加熱設定	High Medium Low
Heat Value Aliran Udara 加熱值	High: 9.5W Mid: 4.5W Low: 2.3W
Size Saiz 尺寸	XL
Pockets Poket 口袋	4
Net Weight Berat Bersih 淨重	0.5kg (1.1lbs.)
Continuous Usage Time (approx.) Masa Penggunaan Berterusan 连续使用时间	Low: 29 hrs Medium: 17 hrs High: 8 hrs with BL1850B

Polyester

- High repellency fabric

* All list price shown are for reference only (exclude SST).

* Semua harga yang ditunjukkan adalah untuk rujukan sahaja (tidak termasuk SST). 所有显示的建议零售价仅供参考 (不包括SST)。

Cordless
Tangki Kordless

LED Flashlight
Lampu Cahaya LED
LED 閃光燈

Vacuum Cleaner
Penyedut Vakuum
吸塵器

Drilling / Fastening
Guaian / Pengikat
鑽孔 / 鎖緊

Impact Drilling / Demolition
Guaian / Penanggal
打孔機 / 拆牆機

Cutting
Pemotong
切刀

Grinding / Sanding
Pergasil / Pasrah
磨削 / 磨平

Sawing
Guaian
鋸切

Planing / Routing
Penghalus / Tinggapan
磨平 / 磨光

Others
Lain-lain
其他

Outdoor Power Equipment
Alatan Kerja Luar
園林工具

Thakita
18V



Cordless Heated Blanket

Selimut Elektrik Tanpa Kord 充电式电热毯

Battery pocket

Butang kuasa 电源按钮



1.5m Extension cord

Butang kuasa 电源按钮



*Masa Penggunaan Berterusan
连续使用时间

Continuous Usage Time
with BL1850B
(Low Mode)

29hrs
(approx.)

* Continuous Usage Time/ Work Amount:
Actual performance may vary based on application.
Masa Penggunaan Berterusan / Jumlah Kerja: Prestasi sebenar
mungkin berbeza mengikut aplikasi.
连续使用时间 / 之工作量: 实际使用可能因应用而异。

Washable & Dryable
basuh dan Kering
水洗和烘干

Be sure to remove the battery holder from the blanket before washing and drying

Power button

To turn on the blanket, press and hold the power button for a few seconds. To turn off, press and hold the power button again

Butang kuasa 电源按钮

Temperature adjustment

There are three temperature settings (high, medium, low)

Pelarasan suhu 温度调节

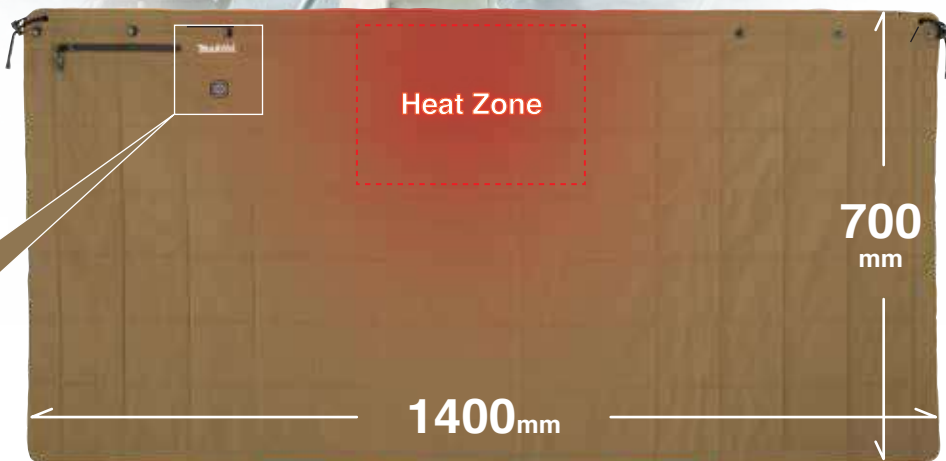
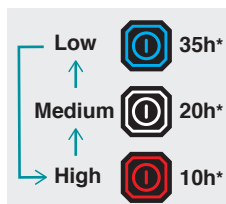

*Continuous runtime on a single full battery charge with BL1860B (18V-6.0Ah Battery)

DCB200B 18V

RM 1,043

Cordless Heated Blanket
Selimut Elektrik Tanpa Kord
充电式电热毯



- Machine-washable and machine-dryable



Standard Equipment: Battery Holder, Storage Bag, Extension Cord

- Without Charger & Battery

Heat Zone Tetapan Aliran Udara 发热区域	Upper Center: 1
Heat Settings Aliran Udara 加热设定	High Medium Low
Heat Value Aliran Udara 加热值	High: 9.5W Med: 4.5W Low: 2.3W
Dimensions (L x W) Dimensi 体积	700x1,400mm (27-1/2"x55")
Net Weight Berat Bersih 净重	0.58kg (1.28lbs.)
Continuous Usage Time (approx.) Masa Penggunaan Berterusan 连续使用时间	Low: 29 hrs Med: 16.5 hrs High: 8 hrs with BL1850B

CB100DB 12Vmax

RM 1,043

Cordless Heated Blanket
Selimut Elektrik Tanpa Kord
充电式电热毯



- Machine-washable and machine-dryable



Standard Equipment: Battery Holder, Storage Bag, Extension Cord

- Without Charger & Battery

Heat Zone Tetapan Aliran Udara 发热区域	Upper Center: 1
Heat Settings Aliran Udara 加热设定	High Medium Low
Heat Value Aliran Udara 加热值	High: 9.5W Med: 4.5W Low: 2.3W
Dimensions (L x W) Dimensi 体积	700x1,400mm (27-1/2"x55")
Net Weight Berat Bersih 净重	0.58kg (1.28lbs.)
Continuous Usage Time (approx.) Masa Penggunaan Berterusan 连续使用时间	Low: 14 hrs Med: 7.5 hrs High: 4 hrs with BL1041B

* All list price shown are for reference only (exclude SST).

* Semua harga yang ditunjukkan adalah untuk rujukan sahaja (tidak termasuk SST). 所有显示的建议零售价仅供参考 (不包括SST)。

- Cordless Impact Driver
- LED Flashlight Lampu Suluh LED LED 手电筒
- Vacuum Cleaner Penapisan Vakuum 吸尘器
- Drilling / Fastening 钻孔 / 紧固
- Impact Drilling / Demolition 钻孔 / 拆除
- Cutting 切割
- Grinding / Sanding 打磨 / 砂磨
- Sawing 锯切
- Planing / Routing 刨削 / 铣削
- Others 其他
- Outdoor Power Equipment 户外动力设备



LED FLASHLIGHT

Lampu Suluh LED LED照明灯

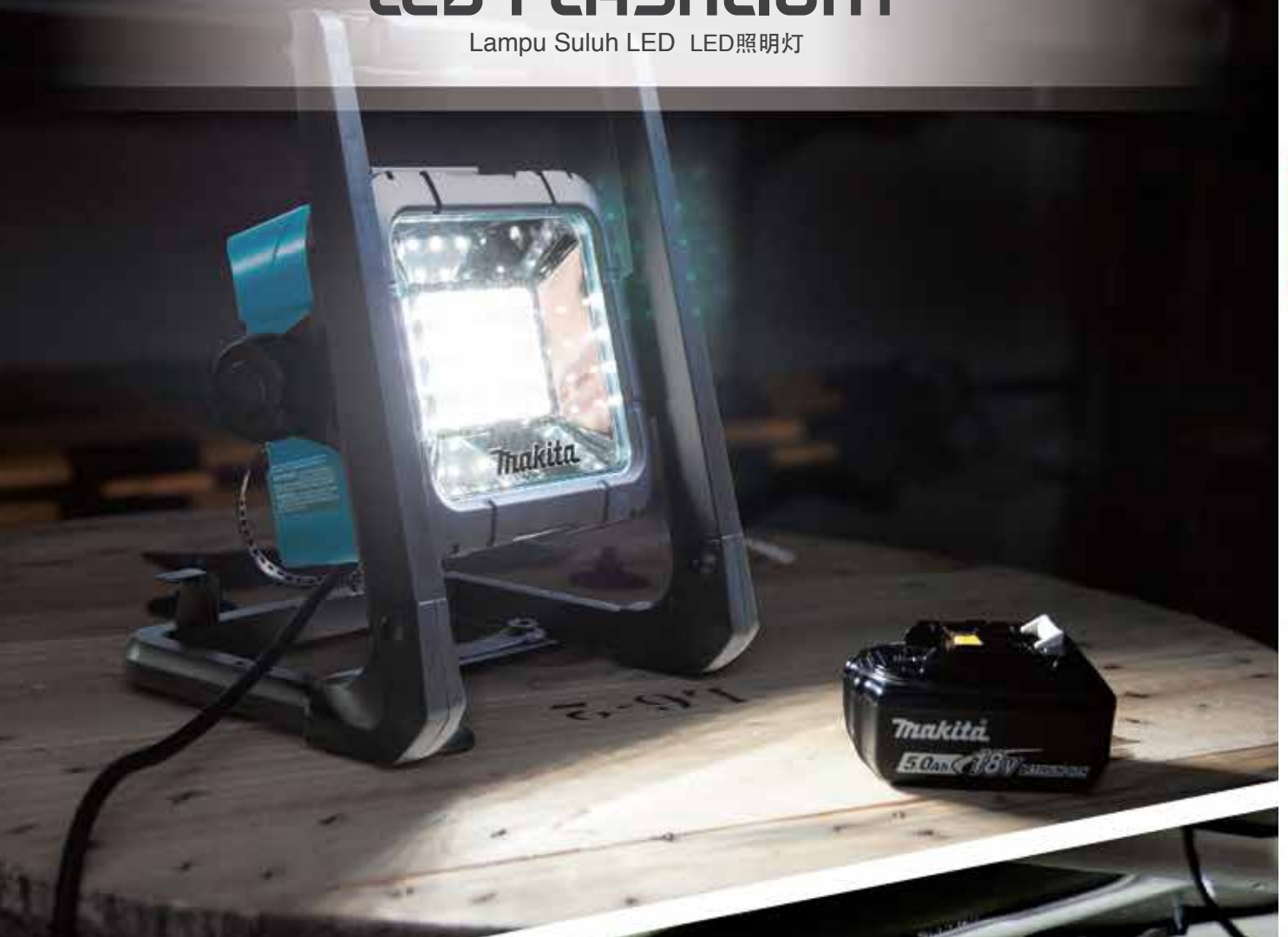

Cordless
Tersedia Untuk Semua

LED Flashlight
Lampu Suluh LED
LED照明灯

Vacuum Cleaner
Penyedot Debu
吸尘器

Drilling / Fastening
Gergaji / Pengikat
DRILL / 电钻

Impact Drilling / Demolition
Gergaji / Perusak
IMPACT DRILL / 电锤

Cutting
Pemotong
切割机

Grinding / Sanding
Penghalus / Halus
GRIND / 砂纸

Sawing
Gergaji
电锯

Planing / Routing
Penghalus / Troggong
PLANER / 刨床

Others
Lain-lain
其他

Outdoor Power Equipment
Alat-alat tenaga
户外动力设备

Makita
工具

18V

LXT

Li-ion Ah 6.0 | 5.0 | 4.0 | 3.0 | 2.0 | 1.5

Cordless Area Worklight

Lampu Kerja Kawasan Tanpa Kord 充电式区域工作灯

Light Diffusing Lens
202 super luminous daylight white LEDs:
40.4W (0.2W x 202)



Inlet type AC power supply cord

Detachable and can be stored compactly on the back of the light body
Wayar elektrik boleh disimpan dengan padat di bahagian belakang badan lampu
电源线可紧凑地存放在灯体的背面

Switch

Panel Kawalan 控制面板

Reflector

Glow in the dark
Bercahaya dalam gelap
黑暗中发光

Adjustable illumination area



Controller with memory function remembers the brightness setting and the lighting area setting last time you power off, allowing the user to avoid adjusting again.
Pengawal dengan fungsi memori mengingati tetapan kecerahan dan tetapan kawasan pencahayaan ketika terakhir anda mematikan, membolehkan pengguna mengelakkan penyesuaian lagi.
具有存储功能的控制器会在您上次关闭电源时记住亮度设置和照明区域设置，从而使用户避免再次进行调整。

3-stage brightness switch



Low	Medium	High
1,500 lm	3,000 lm	5,500 lm
18 h	8.5 h	4.0 h

Continuous run time (Battery : BL1860Bx2)

DML810 18V / AC
Price TBA

Cordless Area Worklight
Lampu Kerja Kawasan Tanpa Kord
充电式区域工作灯



• Self-righting design won't fall over even if bumped



Standard Equipment: AC Power Cord

• Without Charger & Battery

Luminous Flux Cahaya Fluks 发光通量	High: 5,500lm Mid: 3,000lm Low: 1,500lm
illumination Pencahayaan 照度	at 1m from the light source: 550 / 300 / 150 lx at 3m from the light source: 70 / 40 / 20 lx at 5m from the light source: 25 / 15 / 7 lx
Dimensions (L x W x H) Dimensi 体积	420x420x787mm (16-1/2"x16-1/2"x31")
Net Weight Berat Bersih 净重	13.9 - 15.3kg (30.6 - 33.7lbs.)
Continuous Usage Time (approx.) Masa Penggunaan Berterusan 连续使用时间	18 hrs with BL1850B x2

DML808 (AUAML808) 18V
RM 329.50

Cordless LED Flashlight
Lampu Suluh LED Tanpa Kord
充电式LED照明灯

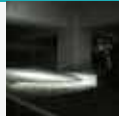

• Multifaceted Reflector Illuminates Evenly for Increased Visibility



• Without Charger & Battery

Luminous Flux Cahaya Fluks 发光通量	190lm
illumination Pencahayaan 照度	at 1m from the light source: 170 - 4,500lx
Dimensions (L x W x H) Dimensi 体积	297x79x119mm (11-3/4"x3-1/8"x4-11/16")
Net Weight Berat Bersih 净重	0.73 - 1.09kg (1.6 - 2.4lbs)
Continuous Usage Time (approx.) Masa Penggunaan Berterusan 连续使用时间	26 hrs with BL1850B

DML807 (AUBDML807) 18V
Price TBA

Cordless LED Flashlight
Lampu Suluh LED Tanpa Kord
充电式LED照明灯

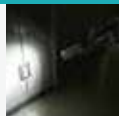

• USB power supply switch with auto-off function for saving battery power



• Without Charger & Battery

Main light (on bar side) Lampu Utama 主灯	Luminous flux (Full brightness): 710 lm illumination (Full brightness): 340 lx Luminous flux (Half brightness): 340 lm illumination (Half brightness): 310 lx
Sub light (on top side) Lampu Tambahan 副灯	Luminous flux: 130 lm illumination: 1,900 lx
Dimensions (L x W x H) Dimensi 体积	414x79x155mm (16-1/4"x3-1/8"x6-1/8")
Net Weight Berat Bersih 净重	0.72 - 1.1kg (1.6 - 2.4lbs.)
Continuous Usage Time (approx.) Masa Penggunaan Berterusan 连续使用时间	43 hrs with BL1850B

XPT

* All list price shown are for reference only (exclude SST).

* Semua harga yang ditunjukkan adalah untuk rujukan sahaja (tidak termasuk SST). 所有显示的建议零售价仅供参考 (不包括SST)。

Cordless
Tanpa Kord 无线

LED Flashlight
Lampu Suluh LED
LED照明灯

Vacuum Cleaner
Pembersih Vakuam
吸尘器

Drilling / Fastening
General / Pengiraian
Mata / 螺絲

Impact Drilling / Demolition
General / Pengiraian
Mata / 螺絲

Cutting
Memotong
切割

Grinding / Sanding
Pengiraian / Poles
磨 / 打磨

Sawing
Gergaji
锯

Planing / Routing
Pengiraian / Pengiraian
Mata / 螺絲

Others
Lain-lain
其他

Outdoor Power Equipment
Alatan Kuasa Luar
器材 / 户外

Makita
Makita

18V

LXT

Li-ion Ah 6.0 | 5.0 | 4.0 | 3.0 | 2.0 | 1.5

Cordless Flashlight

Lampu Suluh Tanpa Kord 充电式照明灯



Variable-angle head
Sudut laras 可调角度



Switch
Panel Kawalan 控制面板

4 Mode switch
Suis 4 Mod 4模式开关



Hook
cangkuk 钩

4 MODES

600lm	1,250lm
Spot	Spot + Flood
1,000lm	1,250lm
Flood	Strobe



DML812 (TWADML812) 18V
Price TBA

Cordless Flashlight
Lampu Suluh Tanpa Kord
充电式照明灯



NEW
BARU 新

- Super luminous daylight white LEDs

Standard Equipment: Strap Hook

- Without Charger & Battery



Luminous Flux Cahaya Fluks 发光通量	Spot: 600 lm Flood: 1,000 lm Spot-Flood: 1,250 lm
illuminance Pencahayaannya 照度	Spot: 71,000 lx Flood: 520 lx Spot-Flood: 51,000 lx
Dimensions (L x W x H) Dimensi 体积	313x119x115mm (12-3/8"x4-11/16"x4-1/2")
Net Weight Berat Bersih 净重	1.2 - 1.6kg (2.6 - 3.4lbs.)
Continuous Usage Time (approx.) Masa Penggunaan Berterusan 连续使用时间	Spot: 8.5 hrs Flood: 6.5 hrs Spot-Flood: 5.0 hrs Strobe: 7.0 hrs with BL1850B

DML802 (DEADML802) 18V
RM 319

Cordless LED Flashlight
Lampu Suluh LED Tanpa Kord
充电式LED照明灯



- 12 position pivoting flashlight head with positive stops from -60° - 110°

- Without Charger & Battery

Dimensions (L x W x H) Dimensi 体积	272x79x116mm (10-3/4"x3-1/8"x4-9/16")
Net Weight Berat Bersih 净重	0.65kg (1.5lbs)
Continuous Usage Time (approx.) Masa Penggunaan Berterusan 连续使用时间	20 hrs with BL1850B

DML801 (DEADML801) 18V
RM 297.70

Cordless LED Flashlight
Lampu Suluh LED Tanpa Kord
充电式LED照明灯

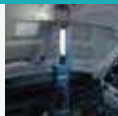

- Metal hang hook swivels 360° and folds away for extra convenience

- Without Charger & Battery

Dimensions (L x W x H) Dimensi 体积	380x79x116mm (15"x9-11/16"x4-9/16")
Net Weight Berat Bersih 净重	0.68kg (1.5lbs)
Continuous Usage Time (approx.) Masa Penggunaan Berterusan 连续使用时间	15 hrs with BL1850B

* All list price shown are for reference only (exclude SST).
* Semua harga yang ditunjukkan adalah untuk rujukan sahaja (tidak termasuk SST). 所有显示的建议零售价仅供参考 (不包括SST)。

Cordless
Tempa Kord 无线

LED Flashlight
Lampu Suluh LED
LED 照明灯

Vacuum Cleaner
Penisap Vakuum
吸尘器

Drilling / Fastening
Gamat / Pengikat
电钻 / 螺絲

Impact Drilling / Demolition
Gamat / Pemusnah
电钻 / 电锤

Cutting / Finishing
Pemotong
切割机

Grinding / Sanding
Pengisar / Hujung
砂轮机 / 打磨

Sawing
Gergaji
电锯

Planing / Routing
Polish / Tunggai
刨花机 / 压花

Others
Lain-lain
其他

Outdoor Power Equipment
Alat Kerja Luar
户外动力设备

Makita
1 INT



Cordless
Tanpa Kord / 无线电

LED Flashlight
Lampu Suluh LED
LED照明灯

Vacuum Cleaner
Pembersih Vakuum
吸尘器

Drilling / Fastening
Gencat / Pasang
钻孔 / 紧固

Impact Drilling / Demolition
Gencat / Patahkan
冲击钻孔 / 拆除加工

Cutting
Memotong
切割

Grinding / Sanding
Menggosok / Mengkilap
打磨 / 抛光

Sanding
Menggosok
打磨

Planing / Routing
Pengaliran / Tumpang
刨削 / 榫槽

Others
Lain-lain
其他

Outdoor Power Equipment
Alat-alat Kertas Luar
园机 / 户外

Makita
T.M.T.

DML805 (GBDML805) 18V / AC
RM 985.50

Corded and Cordless LED Worklight

Lampu Kerja LED Kuasa Elektrik dan Tanpa Kord
电源及充电式LED工作灯

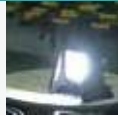

- 2-mode operation: delivers 750 lumens on high mode or 450 lumens on low mode

• Without Charger & Battery

Luminous Flux Cahaya Fluks 发光通量	Hi: 750lm, Lo: 450lm
illuminance Pencahayaanan 照度	at 0.5m from the light source Hi: 1,150lx, Lo: 750lx at 1m from the light source Hi: 300lx, Lo: 200lx
Dimensions (L x W x H) Dimensi 体积	214x261x328mm (8-3/8"x10-1/4"x12-7/8")
Net Weight Berat Bersih 净重	2.3 - 2.7kg (5.1 - 5.9lbs)
Continuous Usage Time (approx.) Masa Penggunaan Berterusan 连续使用时间	10.5 hrs with BL1850B

DML186 (DEADML186) 18V
RM 103.10

Cordless LED Flashlight
Lampu Suluh LED Tanpa Kord
充电式LED工作灯

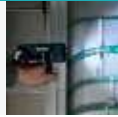

- Hand strap for extra convenience

• Without Charger & Battery

Dimensions (L x W x H) Dimensi 体积	151x81x61mm (5-7/8"x3-3/16"x2-3/8")
Net Weight Berat Bersih 净重	0.54kg (1.18lbs)
Continuous Usage Time (approx.) Masa Penggunaan Berterusan 连续使用时间	50 hrs with BL1850B

ML104 (AUAML104) 12Vmax
Price TBA

Cordless LED Flashlight
Lampu Suluh LED Tanpa Kord
充电式LED照明灯



- USB power supply switch with auto-off function for saving battery power

• Without Charger & Battery

Main light (on bar side) Lampu Utama 主灯	Luminous flux (Full brightness): 710 lm
Sub light (on top side) Lampu Tambahan 副灯	illuminance (Full brightness): 340 lx
Dimensions (L x W x H) Dimensi 体积	Luminous flux: 130 lm
Net Weight Berat Bersih 净重	illuminance: 1,900 lx
Continuous Usage Time (approx.) Masa Penggunaan Berterusan 连续使用时间	Dimensions (L x W x H) (16-1/4"x2-5/8"x5-3/16")
	Net Weight 0.61 - 0.78 kg (1.4 - 1.7 lbs.)
	Continuous Usage Time (approx.) 19 hrs with BL1041B

ML105 (AUAML105) 12Vmax
RM 303.70

Cordless LED Flashlight
Lampu Suluh LED Tanpa Kord
充电式LED手电筒



- Multifaceted Reflector Illuminates Evenly for Increased Visibility

Standard Equipment: Strap Hook

• Without Charger & Battery

Luminous Flux Cahaya Fluks 发光通量	190lm
illuminance Pencahayaanan 照度	at 1m from the light source 5,500lx
Dimensions (L x W x H) Dimensi 体积	249x66x93mm (9-3/4"x2-5/8"x3-5/8")
Net Weight Berat Bersih 净重	0.53 - 0.70kg (1.2 - 1.5lbs.)
Continuous Usage Time (approx.) Masa Penggunaan Berterusan 连续使用时间	7 hrs with BL1021B

ML106 (AUAML106) 12Vmax
RM 329.50

Cordless LED Flashlight
Lampu Suluh LED Tanpa Kord
充电式LED手电筒



- Multifaceted Reflector Illuminates Evenly for Increased Visibility

Standard Equipment: Strap Hook

• Without Charger & Battery

Luminous Flux Cahaya Fluks 发光通量	190lm
illuminance Pencahayaanan 照度	at 1m from the light source 170 - 4,500lx
Dimensions (L x W x H) Dimensi 体积	271x66x93mm (10-5/8"x2-5/8"x3-5/8")
Net Weight Berat Bersih 净重	0.61 - 0.78kg (1.3 - 1.7lbs)
Continuous Usage Time (approx.) Masa Penggunaan Berterusan 连续使用时间	6 hrs with BL1021B



VIDEO CLIP
Models and prices may vary by country

* All list price shown are for reference only (exclude SST).

* Semua harga yang ditunjukkan adalah untuk rujukan sahaja (tidak termasuk SST). 所有显示的建议零售价仅供参考 (不包括SST)。



ML103 (AUAML103) 12Vmax
RM 175.50

Cordless LED Flashlight
Lampu Suluh LED Tanpa Kord
充电式LED手电筒



• 1.5W white single diffusion LED provides bright and wide illumination

• Without Charger & Battery

Dimensions (L x W x H) 77x54x28mm
Dimensi 体积 (3x2-1/8x1-1/8")
Net Weight 0.27 - 0.43kg (0.6 - 1.0lbs)
Berat Bersih 淨重
Continuous Usage Time (approx.) 14 hrs with BL1021B
Masa Penggunaan Berterusan 连续使用时间

Product Comparison List 18V 12V max AC

Senarai Perbandingan Produk 产品对比表

	DML808	ML106	DML802	ML105	DML801	DML186
	Zoom Function	Zoom Function				
Run time (hrs)	Up to: 26 with BL1850B	Up to: 12 with BL1041B	Up to: 23 with BL1850B	Up to: 14 with BL1041B	Up to: 17 Full: with BL1850B Up to: 40 Half: with BL1850B	Up to: 95 with BL1850B
Illuminance	170 - 4,500lx at 1m from the light	170 - 4,500lx at 1m from the light	4,000lx at 1m from the light	5,500lx at 1m from the light	Full: 400lx Half: 200lx at 0.5m from the light	500lx at 1m from the light
Luminous flux (lm=lumens)	190lm	190lm	180lm	190lm	Full: 240lm Half: 120lm	-
Net weight	0.73 - 1.09kg (1.6 - 2.4lbs)	0.61 - 0.78kg (1.3 - 1.7lbs)	0.64 - 1.0kg (1.4 - 2.2lbs)	0.53 - 0.70kg (1.2 - 1.5lbs)	0.61 - 0.98kg (1.4 - 2.2lbs)	0.51 - 0.83kg (1.1 - 1.8lbs)
	DML807	ML104	DML812	DML810	DML805	ML103
	XPT	XPT				
Run time (hrs)	Up to: 23 Main light (1/2) with BL1850B Up to: 36 Sub light with BL1850B	Up to: 17 Main light (1/2) with BL1041B Up to: 19 Sub light with BL1041B	Up to: 8 with BL1850B	Up to: 15 with BL1850B x2	Up to: 8.5 Hi: with BL1850B Up to: 17 Lo: with BL1850B	Up to: 28 with BL1041B
Illuminance	Main light (Full): 340lx Main light (1/2): 310lx Sub light (On Top): 1,900lx at 0.5m from the light	Main light (Full): 340lx Main light (1/4): 190lx Sub light (On Top): 1,900lx at 0.5m from the light	71,000lx 51,000lx 520lx at 1m from the light	550lx 300lx 150lx at 1m from the light	Hi: 1,150lx, Lo: 750lx at 0.5m from the light Hi: 300lx, Lo: 200lx at 1m from the light	240lx at 0.5m from the light 50lx at 1m from the light
Luminous flux (lm=lumens)	Main light (Full): 710lm Main light (1/2): 340lm Sub light (On Top): 130lm	Main light (Full): 710lm Main light (1/4): 190lm Sub light (On Top): 130lm	Spot: 600lm Spot/ Flood: 1,250lm Flood: 1,000lm	High: 5,500lm Med: 3,000lm Low: 1,500lm	Hi: 750lm Lo: 450lm	100lm
Net weight	0.72 - 1.1kg (1.6 - 2.4lbs)	0.61 - 0.78kg (1.4 - 1.7lbs)	1.7kg (3.8lbs)	13.9 - 15.3kg (30.6 - 33.7lbs)	2.3 - 2.7kg (5.1 - 5.9lbs)	0.27 - 0.43kg (0.6 - 1.0lbs)

* All list price shown are for reference only (exclude SST).

* Semua harga yang ditunjukkan adalah untuk rujukan sahaja (tidak termasuk SST). 所有显示的建议零售价仅供参考 (不包括SST)。

Cordless
Tanpa Kord 无绳

LED Flashlight
Lampu Suluh LED
LED手电筒

Vacuum Cleaner
Penyedut Vakuum
吸尘器

Drilling / Fastening
Gores / Pengikat
电钻 / 螺絲

Impact Drilling / Demolition
Darus / Romban
电钻 / 电锤

Cutting
Pemotong
切割机

Grinding / Sanding
Hirau / Hecah
砂磨 / 砂纸

Sawing
Gergaji
电锯

Planing / Routing
Polir / Tunggam
刨 / 压边

Others
Lain-lain
其他

Outdoor Power Equipment
Alat Kerja Luar
户外设备



VACUUM CLEANER

Pembersih Vakum 吸尘器

Cordless
Terdapat Model Tanpa Kabel

LED Flashlight
Lampu Senter LED
LED Senter

Vacuum Cleaner
Pembersih Vakum
吸尘器

Drilling | Fastening
Dapat / Pasang
M3, | 2.5

Impact Drilling | Demolition
Gerus / Perusak
6.3, 6.7, | 2.5, 3.2, 3.5

Cutting
Pemotong
5.5

Grinding | Sanding
Gerus / Pasir
2.5, | 2.5

Sawing
Gergaji
5.5

Piercing | Routing
Pergesekan / Pengisian
3.0, | 3.0

Others
Lain-lain
2.5

Outdoor Power Equipment
Alat-alat Tenaga Listrik
3.0, 3.5, 4.0





Li-ion Ah 6.0 | 5.0 | 4.0 | 3.0 | 2.0 | 1.5



DVC150LZ
RM 6,217

Corded & Cordless Vacuum Cleaner (Wet & Dry)
Pembersih Vakum Kuasa Elektrik Dan Tanpa Kord (Basah dan Kering)
充电式 + 电源驱动吸尘机(干湿两用)



WET
Basah 湿
DRY
Kering 干

- For both wet and dry vacuum cleaning

Standard Equipment: Floor Nozzle, Corner Nozzle, Straight Pipe, Bent Pipe, Hose (38mm), Plastic Dust Bag, Plastic Dust Bag x10, Cloth Filter, Tool Box, Connection Cord

- Z: Without Charger & Battery



Capacity Kapasiti 尘袋容量	Dust: 15L Water: 12L
Max Air Flow Aliran Udara 最大空气流量	AC: 3.6m³/min DC: 2.1m³/min
Max Sealed Suction Sedutan Terkedap 最大密封吸力	AC: 24kPa DC: 9kPa
Suction Power Kuasa Sedutan 吸力	AC: 320W DC: 25 - 70W
Dimensions (L x W x H) Dimensi 体积	366x334x421mm (14-3/8"x13-1/8"x16-1/2")
Net Weight Berat Bersih 净重	8.9 - 9.6kg (19.7 - 21.1lbs.)
Continuous Usage Time (approx.) Masa Penggunaan Berterusan 连续使用时间	65 min with BL1850B x2

DVC151LZ
RM 7,038

Corded and Cordless Vacuum Cleaner (Dry)
Pembersih Vakum Kuasa Elektrik Dan Tanpa Kord (Kering)
充电式 + 电源驱动吸尘机(干用)



DRY
Kering 干

- 15L Large dust bag capacity

Standard Equipment: Floor Nozzle, Corner Nozzle, Straight Pipe, Bent Pipe, Hose (38mm), Hose (28mm), Front Cuffs (22, 24, 28), Plastic Dust Bag, Plastic Dust Bag x10, Cloth Filter, Damper, Dry Powder Filter, Tool Box, Connection Cord

- Z: Without Charger & Battery



Capacity Kapasiti 尘袋容量	Dust: 15L
Max Air Flow Aliran Udara 最大空气流量	AC: 3.6m³/min DC: 2.1m³/min
Max Sealed Suction Sedutan Terkedap 最大密封吸力	AC: 24kPa DC: 9kPa
Suction Power Kuasa Sedutan 吸力	AC: 320W DC: 25 - 70W
Dimensions (L x W x H) Dimensi 体积	366x334x421mm (14-3/8"x13-1/8"x16-1/2")
Net Weight Berat Bersih 净重	9.6 - 10.3kg (21.2 - 22.6lbs.)
Continuous Usage Time (approx.) Masa Penggunaan Berterusan 连续使用时间	65 min with BL1850B x2

DVC152LZ
RM 4,843

Cordless Vacuum Cleaner (Wet & Dry)
Pembersih Vakum Tanpa Kord (Basah dan Kering)
充电式吸尘机(干湿两用)



WET
Basah 湿
DRY
Kering 干

- For both wet and dry vacuum cleaning

Standard Equipment: Floor Nozzle, Corner Nozzle, Straight Pipe, Bent Pipe, Hose (38mm), Plastic Dust Bag, Plastic Dust Bag x10, Cloth Filter, Tool Box

- Z: Without Charger & Battery



Capacity Kapasiti 尘袋容量	Dust: 15L Water: 12L
Max Air Flow Aliran Udara 最大空气流量	2.1m³/min
Max Sealed Suction Sedutan Terkedap 最大密封吸力	9.8kPa
Suction Power Kuasa Sedutan 吸力	90W
Dimensions (L x W x H) Dimensi 体积	366x334x421mm (14-3/8"x13-1/8"x16-1/2")
Net Weight Berat Bersih 净重	7.3 - 7.9kg (16.0 - 17.4lbs.)
Continuous Usage Time (approx.) Masa Penggunaan Berterusan 连续使用时间	40 min with BL1850B x2

DVC153LZ
RM 5,665

Cordless Vacuum Cleaner (Dry)
Pembersih Vakum Tanpa Kord (Kering)
充电式吸尘机(干用)



DRY
Kering 干

- 15L Large dust bag capacity

Standard Equipment: Floor Nozzle, Corner Nozzle, Straight Pipe, Bent Pipe, Hose (38mm), Hose (28mm), Front Cuffs (22, 24, 28), Plastic Dust Bag, Plastic Dust Bag x10, Cloth Filter, Damper, Dry Powder Filter

- Z: Without Charger & Battery



Capacity Kapasiti 尘袋容量	Dust: 15L
Max Air Flow Aliran Udara 最大空气流量	2.1m³/min
Max Sealed Suction Sedutan Terkedap 最大密封吸力	9.8kPa
Suction Power Kuasa Sedutan 吸力	90W
Dimensions (L x W x H) Dimensi 体积	366x334x421mm (14-3/8"x13-1/8"x16-1/2")
Net Weight Berat Bersih 净重	8.0 - 8.6kg (17.6 - 19.0lbs.)
Continuous Usage Time (approx.) Masa Penggunaan Berterusan 连续使用时间	40 min with BL1850B x2

* All list price shown are for reference only (exclude SST).

* Semua harga yang ditunjukkan adalah untuk rujukan sahaja (tidak termasuk SST). 所有显示的建议零售价仅供参考 (不包括SST)。

Cordless
Tempa Kord 无线电

LED Flashlight
Lampu Suluh LED
LECOB002

Vacuum Cleaner
Pembersih Vakum
DVC150LZ

Drilling / Fastening
Pencetus / Pencetus
BL1850B

Impact Drilling / Demolition
Dremel / Demolition
BL1850B

Cutting
Pemotong
DVC150LZ

Grinding / Sanding
Pencetus / Pencetus
BL1850B

Sawing
Gergaji
DVC150LZ

Planing / Routing
Pencetus / Pencetus
BL1850B

Others
Lain-lain
DVC150LZ

Outdoor Power Equipment
Alatan Kuasa Luar
DVC150LZ





Li-ion Ah 6.0 5.0 4.0 3.0 2.0 1.5

DVC154LZ | DVC154LZX
RM 7,365 | RM 6,508

Cordless Vacuum Cleaner (Dry)
Pembersih Vakum Tanpa Kord (Kering)
充电式吸尘器(干用)



- Auto-Start Wireless System (AWS) Connects to Power Tool with Bluetooth

Standard Equipment:

DVC154LZ: Floor Nozzle, Corner Nozzle, Straight Pipe, Bent Pipe, Hose (38mm-2.5m), Plastic Dust Bag, Plastic Dust Bag x10, Cloth Filter, Front Cuffs, Dry Powder Filter, Damper
DVC154LZX: Hose (38mm-2.5m), Plastic Dust Bag, Plastic Dust Bag x10, Cloth Filter, Front Cuffs, Dry Powder Filter, Damper

- Z / ZX: Without Charger & Battery



Capacity Kapasiti 尘袋容量	Dust: 15L
Max Air Flow Aliran Udara 最大空气流量	2.1m ³ /min
Max Sealed Suction Sedutan Terkedap 最大密封吸力	9.8kPa
Suction Power Kuasa Sedutan 吸力	90W
Dimensions (L x W x H) Dimensi 体积	366x334x421mm (14-3/8"x13-1/8"x16-1/2")
Net Weight Berat Bersih 净重	8.0 - 8.6kg (17.6 - 19.0lbs.)
Continuous Usage Time (approx.) Masa Penggunaan Berterusan 连续使用时间	40 min with BL1850B x2

DVC155LZX3
Price TBA

Cordless Vacuum Cleaner (Wet & Dry)
Pembersih Vakum Tanpa Kord (Basah dan Kering)
充电式吸尘器(干湿两用)



- More Powerful Suction Power

Standard Equipment: Floor Nozzle, Long Sash Nozzle, Telescopic pipe assembly, Bent Pipe, Pipe, Hose, Plastic Dust Bag x10, Filter, Tool Box

- ZX3: Without Charger & Battery



Capacity Kapasiti 尘袋容量	Dust: 15L Water: 12L
Max Air Flow Aliran Udara 最大空气流量	2.1m ³ /min
Max Sealed Suction Sedutan Terkedap 最大密封吸力	11kPa
Suction Power Kuasa Sedutan 吸力	105W
Dimensions (L x W x H) Dimensi 体积	366x334x421mm (14-3/8"x13-1/8"x16-1/2")
Net Weight Berat Bersih 净重	7.2 - 7.9kg (15.9 - 17.4lbs.)
Continuous Usage Time (approx.) Masa Penggunaan Berterusan 连续使用时间	83 min with BL1850B x2

DVC157LZX5
Price TBA

Cordless Vacuum Cleaner (Dry)
Pembersih Vakum Tanpa Kord (Kering)
充电式吸尘器(干用)



- Auto-start Wireless System (AWS) connects to power tool with Bluetooth

Standard Equipment: Floor Nozzle, Corner Nozzle, Straight Pipe, Bent Pipe, Hose (38mm-2.5m), Plastic Dust Bag, Plastic Dust Bag x10, Cloth Filter, Tool Box, Damper, Dry Powder Filter

- ZX5: Without Charger & Battery



Capacity Kapasiti 尘袋容量	Dust: 15L
Max Air Flow Aliran Udara 最大空气流量	2.4m ³ /min
Max Sealed Suction Sedutan Terkedap 最大密封吸力	11kPa
Suction Power Kuasa Sedutan 吸力	110W
Dimensions (L x W x H) Dimensi 体积	366x334x421mm (14-3/8"x13-1/8"x16-1/2")
Net Weight Berat Bersih 净重	8.0 - 8.6kg (17.6 - 19.0lbs.)
Continuous Usage Time (approx.) Masa Penggunaan Berterusan 连续使用时间	83 min with BL1850B x2

DVC864LZ
RM 4,878

Cordless Vacuum Cleaner (Dry)
Pembersih Vakum Tanpa Kord (Kering)
充电式吸尘器(干用)



- Auto-Start Wireless System (AWS) Connects to Power Tool with Bluetooth

Standard Equipment: Floor Nozzle, Corner Nozzle, Straight Pipe, Bent Pipe, Hose (38mm), Hose (28mm), Front Cuffs (22, 24, 28), Plastic Dust Bag, Plastic Dust Bag x10, Cloth Filter, Tool Box

- Z: Without Charger & Battery



Capacity Kapasiti 尘袋容量	Dust: 8L
Max Air Flow Aliran Udara 最大空气流量	2.1m ³ /min
Max Sealed Suction Sedutan Terkedap 最大密封吸力	9.8kPa
Suction Power Kuasa Sedutan 吸力	90W
Dimensions (L x W x H) Dimensi 体积	366x334x368 mm (14-3/8"x13-1/8"x14-1/2")
Net Weight Berat Bersih 净重	7.7 - 8.4 kg (17.1 - 18.4 lbs.)
Continuous Usage Time (approx.) Masa Penggunaan Berterusan 连续使用时间	40 min with BL1850B x2

DVC860LZ
RM 4,607

Cordless Vacuum Cleaner (Wet & Dry)
Pembersih Vakum Kuasa Elektrik Dan Tanpa Kord (Basah dan Kering)
充电式 + 电源驱动吸尘器(干湿两用)

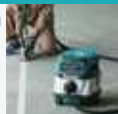

- Cloth filter type: for both wet & dry vacuum cleaning

Standard Equipment:

Floor Nozzle, Corner Nozzle, Straight Pipe, Bent Pipe, Hose (38mm), Plastic Dust Bag, Plastic Dust Bag x10, Cloth Filter, Tool Box, Connection Cord

- Z: Without Charger & Battery



VIDEO CLIP
Models and specs may vary by country
DVC860/DCL500



Capacity Kapasiti 尘袋容量	Dust: 8L Water: 6L
Max Air Flow Aliran Udara 最大空气流量	AC: 3.6m ³ /min DC: 2.1m ³ /min
Max Sealed Suction Sedutan Terkedap 最大密封吸力	AC: 24kPa DC: 9kPa
Suction Power Kuasa Sedutan 吸力	AC: 320W DC: 25 - 70W
Dimensions (L x W x H) Dimensi 体积	366x334x368mm (14-3/8"x13-1/8"x14-1/2")
Net Weight Berat Bersih 净重	8.6kg (19.0lbs.)
Continuous Usage Time (approx.) Masa Penggunaan Berterusan 连续使用时间	65 min with BL1850B x2

* All list price shown are for reference only (exclude SST).

* Semua harga yang ditunjukkan adalah untuk rujukan sahaja (tidak termasuk SST). 所有显示的建议零售价仅供参考 (不包括SST)。

Cordless
Tampal Hout 贴木
LED Flashlight
Lampu Cahaya LED
LED BRIGHT
Vacuum Cleaner
Pembersih Vakum
Drilling / Fastening
Dremel / Pengikat
MILL / 磨床
Impact Drilling / Demolition
Ginjal / Penusuk
BETON / 混凝土
Cutting
Memotong
GEMERIS
Grinding / Sanding
Pengisar / Pasukan
BETON / 磨床
Sanding
Gergaji
Priming / Routing
Pegangan / Troponan
BETON / 磨床
Others
Lain-lain
其他
Outdoor Power Equipment
Alatan Kuasa Luar
BETON / 磨床
Makita
MAKITA



Li-ion Ah 6.0 5.0 4.0 3.0 2.0 1.5

DVC862LPT2 RM 5,307 | **DVC862LRT2** RM 5,007 | **DVC862LZ** RM 3,720

Cordless Vacuum Cleaner (Wet & Dry)
Pembersih Vakum Tanpa Kord
(Basah dan Kering)
充电式吸尘器(干湿两用)



• For both wet and dry vacuum cleaning

Standard Equipment: Floor Nozzle, Corner Nozzle, Straight Pipe, Bent Pipe, Hose (38mm), Plastic Dust Bag, Plastic Dust Bag x10, Cloth Filter, Tool Box

- PT2: 1x Two Port Multi Fast Charger, 2x 5.0Ah Battery
- RT2: 1x Rapid Charger, 2x 5.0Ah Battery
- Z: Without Charger & Battery



Capacity Kapasiti 尘袋容量	Dust: 8L
Max Air Flow Aliran Udara 最大空气流量	Water: 6L 2.1m³/min
Max Sealed Suction Sedutan Terkedap 最大密封吸力	9.8kPa
Suction Power Kuasa Sedutan 吸力	90W
Dimensions (L x W x H) Dimensi 体积	366x334x368mm (14-3/8"x13-1/8"x14-1/2")
Net Weight Berat Bersih 净重	7.0kg (15.5lbs.)
Continuous Usage Time (approx.) Masa Penggunaan Berterusan 连续使用时间	40 min with BL1850B x2

DVC863LPT2 RM 5,918 | **DVC863LRT2** RM 5,618 | **DVC863LZ** RM 4,333

Cordless Vacuum Cleaner (Dry)
Pembersih Vakum Tanpa Kord (Kering)
充电式吸尘器(干用)



• 8L Large dust bag capacity enables continuous cleaning work

Standard Equipment: Floor Nozzle, Corner Nozzle, Straight Pipe, Bent Pipe, Hose (38mm), Hose (28mm), Front Cuffs (22, 24, 38), Plastic Dust Bag, Plastic Dust Bag x10, Cloth Filter, Tool Box

- PT2: 1x Two Port Multi Fast Charger, 2x 5.0Ah Battery
- RT2: 1x Rapid Charger, 2x 5.0Ah Battery
- Z: Without Charger & Battery



Capacity Kapasiti 尘袋容量	Dust: 8L
Max Air Flow Aliran Udara 最大空气流量	2.1m³/min
Max Sealed Suction Sedutan Terkedap 最大密封吸力	9.8kPa
Suction Power Kuasa Sedutan 吸力	90W
Dimensions (L x W x H) Dimensi 体积	366x334x368mm (14-3/8"x13-1/8"x14-1/2")
Net Weight Berat Bersih 净重	7.7kg (17.1lbs.)
Continuous Usage Time (approx.) Masa Penggunaan Berterusan 连续使用时间	40 min with BL1850B x2

DVC265ZX
RM 3,343

Cordless Backpack Vacuum Cleaner
Pembersih Vakum Beg Galas
Tanpa Kord
充电式背负吸尘器



• Increased suction power for improved dust collection

Standard Equipment: Hose, Hose Band, Dust Bag, Front Cuffs (22, 24)

- Z: Without Charger & Battery



Capacity Kapasiti 尘袋容量	Paper Dust Bag: 2.0L Cloth Dust Bag: 1.5L
Max Air Flow Aliran Udara 最大空气流量	w/ Hose Complete 28-1.0: 2.0m³/min w/ Hose Complete 28-1.5: 1.8m³/min
Max Sealed Suction Sedutan Terkedap 最大密封吸力	11kPa
Suction Power Kuasa Sedutan 吸力	w/ Hose 28-1.0: High: 90W Normal: 45W w/ Hose 28-1.5: High: 85W Normal: 45W
Dimensions (L x W x H) Dimensi 体积	230x152x373mm (9"x6"x14-3/4")
Net Weight Berat Bersih 净重	3.9 - 4.5kg (8.6 - 10.0lbs.)
Continuous Usage Time (approx.) Masa Penggunaan Berterusan 连续使用时间	High: 33 min Low: 62 min with BL1850B x2

DVC261Z
RM 2,577

Cordless Backpack Vacuum Cleaner
Pembersih Vakum Beg Galas
Tanpa Kord
充电式背负吸尘器



• Increased Suction Power for Improved Dust Collection

Standard Equipment: HEPA Filter Assembly, Hose Band, Paper Filter Bag (2L), Hose (28mm), Floor Nozzle, Flexible Rubber Nozzle, Telescopic Pipe Assembly, Bent Pipe

- Z: Without Charger & Battery



Capacity Kapasiti 容量	Paper Dust Bag: 2.0L Cloth Dust Bag: 1.5L
Max Air Flow Aliran Udara 最大空气流量	w/ Hose complete 38-1.5: 2.3 m³/min w/ Hose Complete 32-1.0: 2.2 m³/min w/ Hose Complete 28-1.0: 2.0 m³/min w/ Hose Complete 28-1.5: 1.8 m³/min
Max Sealed Suction Sedutan Terkedap 最大密封吸力	11 kPa
Suction Power Kuasa Sedutan 吸力	Max/ High/ Normal w/ Hose 38-1.5: 105/ 55/ 30W Max/ High/ Normal w/ Hose 32-1.0: 95/ 50/ 25W Max/ High/ Normal w/ Hose 28-1.0: 90/ 45/ 25W Max/ High/ Normal w/ Hose 28-1.5: 85/ 45/ 25W
Dimensions (L x W x H) Dimensi 体积	230x152x373mm (9"x6"x14-3/4")
Net Weight Berat Bersih 净重	3.8 - 4.5kg (8.5 - 9.9lbs.)
Continuous Usage Time (approx.) Masa Penggunaan Berterusan 连续使用时间	Normal: 115 min High: 63 min Max: 33 min with BL1850B x2

DVC260Z RM 2,078 | **DVC260ZX** RM 2,078

Cordless Backpack Vacuum Cleaner
Pembersih Vakum Beg Galas
Tanpa Kord
充电式背负吸尘器



• Max suction power 45W

Standard Equipment:
DVC260Z: HEPA Filter Assembly, Backpack Shoulder Harness, Hose Band, Paper Filter Bag (2L), Hose 28mm (1.0M), Floor Nozzle, Flexible Rubber Nozzle, Telescopic Pipe Assembly, Bent Pipe
DVC260ZX: HEPA Filter Assembly, Backpack Shoulder Harness, Hose Band, Paper Filter Bag (2L), Hose 28mm (1.5M), Front Cuffs (22, 24)

- Z / ZX: Without Charger & Battery



DVC260

Models and specs may vary by country



Capacity Kapasiti 容量	Filter bag / Paper dust bag: 2.0L Cloth dust bag: 1.5L
Max Air Flow Aliran Udara 最大空气流量	1.5m³/min
Max Sealed Suction Sedutan Terkedap 最大密封吸力	7.1kPa (710mmH ₂ O)
Suction Power Kuasa Sedutan 吸力	High: 45W Low: 25W
Dimensions (L x W x H) Dimensi 体积	230x152x373mm (9"x6"x14-3/4")
Net Weight Berat Bersih 净重	3.8kg (8.5 lbs)
Continuous Usage Time (approx.) Masa Penggunaan Berterusan 连续使用时间	Low: 90 min High: 60 min with BL1850B x2

* All list price shown are for reference only (exclude SST).

* Semua harga yang ditunjukkan adalah untuk rujukan sahaja (tidak termasuk SST). 所有显示的建议零售价仅供参考 (不包括SST)。

Cordless
Tempa Kord 无线

LED Flashlight
Lampu Flash LED
LECOB002

Vacuum Cleaner
Pembersih Vakum
吸尘器

Drilling / Fastening
Gergaji / Pengikat
电钻 / 螺絲

Impact Drilling / Demolition
Gergaji / Perseki
电钻 / 电锤

Cutting
Pemotong
切割机

Grinding / Sanding
Gergaji / Habis
砂磨 / 砂磨

Sawing
Gergaji
电锯

Planing / Routing
Pegangan / Tanggan
刨花 / 刨花

Others
Lain-lain
其他

Outdoor Power Equipment
Alatan Kuasa Luar
户外动力设备

Makita
1911



Li-ion Ah 6.0 5.0 4.0 3.0 2.0 1.5

Cordless Backpack Vacuum Cleaner

Pembersih Vakum Beg Galas Tanpa Kord 充电式背负吸尘机

DVC660

DVC665



Dust Capacity
Kapasiti Habuk 集尘容量

6L

with paper dust bag

Max Sealed Suction
Sedutan Terkedap (Turus Air)
最大密封吸力(水柱)

11 kPa

HEPA filter

HEPA Filter is used as the main filter to capture very fine particles effectively
Penapis HEPA digunakan sebagai penapis utama, yang dapat menangkap zarah-zarah yang sangat halus
HEPA过滤器用作主要过滤器, 可有效捕获非常细的颗粒

Able to capture 99.97% of particles as small as 0.3-1µm

Mampu menangkap 99.97% zarah sekecil 0.3-1µm
99.97% 能够捕获小至0.3-1µm的颗粒



Cleaning mechanism for paper dust bag

Mekanisme pembersih beg habuk kertas 纸尘袋的清洁机制



This mechanism can be actuated:

- Automatically by the vibration due to walking
- Manually by operating a lever by hand
- Secara automatik oleh getaran kerana berjalan
- Secara manual dengan mengoperasikan tuas dengan tangan
- 行走时自动振动 · 手动操纵杆

DVC660Z

RM 3,118

Cordless Backpack Vacuum Cleaner

Pembersih Vakum Beg Galas Tanpa Kord
充电式背负吸尘机

- Increased suction power for improved dust collection

Standard Equipment: Floor Nozzle, Hose, Hose Band, Nozzle Assembly, Telescopic Pipe Assembly, Bent Pipe, Free Nozzle, Dust Bag

- Z: Without Charger & Battery



Capacity

Kapasiti 尘袋容量

Paper Dust Bag: 6.0L

Cloth Dust Bag: 5.5L

Max Air Flow

Aliran Udara 最大空气流量

w/ Hose complete 32-1.0: 2.2m³/min

Max Sealed Suction

Sedutan Terkedap 最大密封吸力

w/ Hose Complete 28-1.0: 2.0m³/min

11kPa

Suction Power

Kuasa Sedutan 吸力

Max: 90W | High: 45W | Normal: 25W

Dimensions (L x W x H)

Dimensi 体积

297x174x523mm

Net Weight

Berat Bersih 净重

6.1 - 6.7kg (13.4 - 14.8lbs.)

Continuous Usage Time (approx.)

Masa Penggunaan Berterusan 连续使用时间

Max: 33 min | High: 62 min |

Normal: 116 min with BL1850B x2

DVC665Z

RM 3,773

Cordless Backpack Vacuum Cleaner

Pembersih Vakum Beg Galas Tanpa Kord
充电式背负吸尘机

- Increased suction power for improved dust collection

Standard Equipment: Hose Band, Filter Bag, Hose 28-1.5, Front Cuffs (22, 24)

- Z: Without Charger & Battery



Capacity

Kapasiti 尘袋容量

Paper Dust Bag: 6.0L

Cloth Dust Bag: 5.5L

Max Air Flow

Aliran Udara 最大空气流量

w/ Hose Complete 28-1.5: 1.8 m³/min

Max Sealed Suction

Sedutan Terkedap 最大密封吸力

11kPa

Suction Power

Kuasa Sedutan 吸力

High: 85W | Normal: 45W

Dimensions (L x W x H)

Dimensi 体积

297x174x523mm

Net Weight

Berat Bersih 净重

6.1 - 6.7kg (13.5 - 14.9lbs.)

Continuous Usage Time (approx.)

Masa Penggunaan Berterusan 连续使用时间

High: 33 min | Normal: 62 min |

with BL1850B x2

* All list price shown are for reference only (exclude SST).

* Semua harga yang ditunjukkan adalah untuk rujukan sahaja (tidak termasuk SST). 所有显示的建议零售价仅供参考 (不包括SST)。

Cordless
Tanpa Kabel 无线

LED Flashlight
Lampu Cahaya LED
LED 闪光灯

Vacuum Cleaner
Pembersih Vakum
吸尘器

Drilling / Fastening
Dremel / Pengikat
电钻 / 螺絲

Impact Drilling / Demolition
Gimbal / Penembak
电钻 / 电锤

Cutting
Pemotong
切割机

Grinding / Sanding
Pengisar / Pasir
打磨 / 砂磨

Sawing
Gergaji
电锯

Planing / Routing
Pencetakan / Tropezan
刨 / 雕

Others
Lain-lain
其他

Outdoor Power Equipment
Alatan Kuasa Luar
户外动力设备



18V

LXT

Li-ion Ah 6.0 5.0 4.0 3.0 2.0 1.5

Robotic Cleaner

Pembersih Robotik 充电式智能吸尘器

Able to clean surface area of **500m²** with BL1850B x2
 Boleh membersihkan kawasan permukaan Seluas 500m² dengan BL1850B x2
 使用2粒BL1850B型电池的可清洁500m²的面积



Large Capacity
 Kapasiti besar 最大容量
2.5L

*Masa Penggunaan Berterusan
 连续使用时间
Continuous Usage Time
 with BL1850B x2
 (Normal Speed)
200min
 (approx.)

Selectable two dust collection modes

Pemilihan dua mod koleksi habuk 可选择两种集尘模式

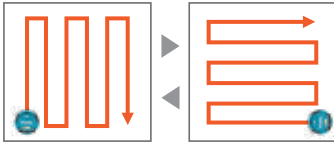

Pattern cleaning mode

Mod pembersihan corak 规则清理模式

For cleaning wide spaces with few obstacles. (Ex.) well-organized warehouses, long corridors, etc.
 Untuk membersihkan ruang yang luas dengan beberapa halangan. (contoh) gudang yang teratur, koridor panjang, dan lain-lain.
 适用于清洁较宽的空间和障碍物少的场所 (例如: 摆放规则的仓库, 太长的走廊等)

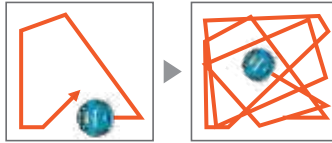

Random cleaning mode

Mod pembersihan secara rawak 随机清洗模式

For cleaning locations with many obstacles. (Ex.) offices, etc.
 Untuk membersihkan lokasi dengan banyak halangan. (contoh) Pejabat, dan lain-lain.
 适用于清洁障碍物较多的场所 (例如: 办公室等)



DRC200Z

RM 11,285

Robotic Cleaner
 Pembersih Robotik
 充电式智能吸尘器



- Able to clean an area of 300m² per 120 min with a coverage rate of 80%

Standard Equipment: Wireless remote controller (including two AAA alkaline batteries), Side Brush, Boundary Tape

• Z: Without Charger & Battery



Max Cleaning Area Kawasan Pembersihan Maksimum 最大清洁面积	BL1850B x2 : 500m ²
Max Running Speed Kelajuan Operasi Maksimum 最大运行速度	0.3m/ sec
Dust Box Capacity Kapasiti 容量	2.5L
Dimensions (L x W x H) Dimensi 体积	460x460x180mm (18-1/8"x18-1/8"x7-1/8")
Net Weight Berat Bersih 淨重	7.3kg (16.1lbs)
Continuous Usage Time (approx.) Masa Penggunaan Berterusan 连续使用时间	200 min with BL1850B x2

DCL501Z

RM 2,528

Cordless Cyclone Cleaner
 Pembersih Vakum Cyclone
 Tanpa Kord
 充电式旋风吸尘器



- Quiet operation for operator comfort

Standard Equipment: Shoulder Belt, Crevice Nozzle, Cleaning Brush, Floor Nozzle, Zoom Pipe, Hose, Hose Hook

• Z: Without Charger & Battery



Capacity Kapasiti 容量	250mL
Max Air Flow Aliran Udara 最大空气流量	1.2m ³ /min
Max Sealed Suction (water column) Sedutan Terkedap (Turus Air) 最大密封吸力(水柱)	10kPa (1,020mmH ₂ O)
Suction Power Kuasa Sedutan 吸力	High: 75W Low: 25W
Dimensions (L x W x H) Dimensi 体积	352x189x252mm (13-7/8"x7-7/16"x9-7/8")
Net Weight Berat Bersih 淨重	3.1kg (6.8 lbs.)
Continuous Usage Time (approx.) Masa Penggunaan Berterusan 连续使用时间	Low: 64 min High: 29 min with BL1850B

DCL500Z

RM 1,970

Cordless Cyclone Cleaner
 Pembersih Vakum Cyclone
 Tanpa Kord
 充电式旋风吸尘器



- HEPA Clean Filter offers maximum performance for residential and commercial applications

Standard Equipment: Shoulder Belt, Crevice Nozzle, Floor Nozzle, Zoom Pipe, Hose, Hose Hook

• Z: Without Charger & Battery



Capacity Kapasiti 容量	250mL
Max Air Flow Aliran Udara 最大空气流量	1.3m ³ /min
Max Sealed Suction (water column) Sedutan Terkedap (Turus Air) 最大密封吸力(水柱)	6.6kPa (660mmH ₂ O)
Suction Power Kuasa Sedutan 吸力	High: 75W Low: 25W
Dimensions (L x W x H) Dimensi 体积	352x189x252mm (13-7/8"x7-7/16"x9-7/8")
Net Weight Berat Bersih 淨重	3.6kg (7.9 lbs.)
Continuous Usage Time (approx.) Masa Penggunaan Berterusan 连续使用时间	Low: 50 min High: 20 min with BL1850B

* All list price shown are for reference only (exclude SST).

* Semua harga yang ditunjukkan adalah untuk rujukan sahaja (tidak termasuk SST). 所有显示的建议零售价仅供参考 (不包括SST)。

Cordless
Tempah Kord 无线

LED Flashlight
Lampu Suluh LED
LED 闪光灯

Vacuum Cleaner
Penbesh Vakum
吸尘器

Drilling / Fastening
Gergaji / Pasak
电钻 / 螺絲

Impact Drilling / Demolition
Gergaji / Hancurkan
电钻 / 拆墙

Cutting
Pemotong
切割机

Grinding / Sanding
Pergasi / Habis
砂磨 / 打磨

Sawing
Gergaji
电锯

Planing / Routing
Pergasi / Tengking
刨花 / 雕花

Others
Lain-lain
其他

Outdoor Power Equipment
Alatan Kuasa Luar
户外动力工具

Makita
1915

Cordless
Tempa Tanpa Kabel

LED Flashlight
Lampu Bawah LED
LED BUKU

Vacuum Cleaner
Penyedot Debu

Drilling / Fastening
Gergaji / Pasak

Impact Drilling / Demolition
Gergaji / Perusak

Cutting
Pemotong

Grinding / Sanding
Gergaji / Sanding

Sanding
Gergaji

Planing / Routing
Perataan / Pengalasan

Others
Lain-lain

Outdoor Power Equipment
Alat-alat Luar Ruangan

Makita
Makita

CAPSULE TYPE

Jenis Kapsul 胶囊型



**No need to use paper bag.
This is a cost saving for
repeated use**

Tidak perlu menggunakan beg debu kertas, boleh digunakan semula untuk menjimatkan kos
无需纸袋, 可重复使用以节省成本



Filter Penapis 过滤器
Pre Filter Penapis Depan 前置过滤器

TRIGGER SWITCH

Suis Pemicu 扳机开关



**Ergonomic Handle With Easy
On/ Off Trigger Switch**

Pemegang ergonomik dengan suis pemicu hidup/ mati mudah
符合人体工程学的手柄, 扳机开关



Easy shake off dust filter
High Performance Filter
Penapis prestasi tinggi
高效过滤器

**Easy shake
off filter B set**



**HEPA
filter
Filter H set**

For all LXT & CXT range
using capsule type
(18V & 12Vmax only)



DCL280

Suction Power
Kuasa Sedutan 吸力

45w

Large Capacity
Kapasiti Besar 最大容量

750mL

Net Weight
Berat Bersih 净重

1.2kg



Lock on button



DCL180

Suction Power
Kuasa Sedutan 吸力

30w

Large Capacity
Kapasiti Besar 最大容量

650mL

Net Weight
Berat Bersih 净重

1.2kg



CAPSULE TYPE

Jenis Kapsul 胶囊型



**No need to use paper bag.
This is a cost saving for
repeated use**

Tidak perlu menggunakan beg debu kertas, boleh digunakan semula untuk menjimatkan kos
无需纸袋, 可重复使用以节省成本



Filter Penapis 过滤器
Pre Filter Penapis Depan 前置过滤器

SWITCH BUTTON

Butang Suis 开关按钮



**Simply push a power on button for
continuous use**

Hanya tekan butang kuasa untuk kegunaan berterusan
一按式开关就能持续使用



Easy shake off dust filter
High Performance Filter
Penapis prestasi tinggi
高效过滤器

**Easy shake
off filter B set**



**HEPA
filter
Filter H set**

For all LXT & CXT range
using capsule type
(18V & 12Vmax only)



DCL281F

Suction Power
Kuasa Sedutan 吸力

60w

Large Capacity
Kapasiti Besar 最大容量

750mL

Net Weight
Berat Bersih 净重

1.2kg



DCL181F

Suction Power
Kuasa Sedutan 吸力

30w

Large Capacity
Kapasiti Besar 最大容量

650mL

Net Weight
Berat Bersih 净重

1.2kg



DUST BAG TYPE

Beg Debu Penapis 尘袋型



**Simply by open the front cover
for easy dust bag change**

Hanya dengan membuka penutup depan untuk menukar beg habuk dengan mudah
打开前盖, 简便更换尘袋



Paper Filter
Penapis Kertas 纸制尘袋



Dust Bag
Beg habuk 集尘袋



High Performance Dust Bag
Beg habuk prestasi tinggi 高效集尘袋

**Easy shake off
dust bag**

SWITCH BUTTON

Butang Suis 开关按钮



**Simply push a power on button for
continuous use**

Hanya tekan butang kuasa untuk kegunaan berterusan
一按式开关就能持续使用



DCL182

Suction Power
Kuasa Sedutan 吸力

30w

Large Capacity
Kapasiti Besar 最大容量

500mL

Net Weight
Berat Bersih 净重

1.2kg



* All list price shown are for reference only (exclude SST).

* Semua harga yang ditunjukkan adalah untuk rujukan sahaja (tidak termasuk SST). 所有显示的建议零售价仅供参考 (不包括SST)。



CL106FD

Suction Power
Kuasa Sedutan 吸力

19_w

Large Capacity
Kapasiti Besar 最大容量

600_{mL}

Net Weight
Berat Bersih 淨重

1.0_{kg}



CL100D

Suction Power
Kuasa Sedutan 吸力

14_w

Large Capacity
Kapasiti Besar 最大容量

600_{mL}

Net Weight
Berat Bersih 淨重

0.88_{kg}



BUILT-IN
LITHIUM-ION
BATTERY

CL111D

Suction Power
Kuasa Sedutan 吸力

21_w

Large Capacity
Kapasiti Besar 最大容量

560_{mL}

Net Weight
Berat Bersih 淨重

0.94_{kg}



CL070D

Suction Power
Kuasa Sedutan 吸力

14_w

Large Capacity
Kapasiti Besar 最大容量

600_{mL}

Net Weight
Berat Bersih 淨重

0.81_{kg}



CL108FD

Suction Power
Kuasa Sedutan 吸力

30_w

Large Capacity
Kapasiti Besar 最大容量

600_{mL}

Net Weight
Berat Bersih 淨重

1.0_{kg}



CL107FD

Suction Power
Kuasa Sedutan 吸力

32_w

Large Capacity
Kapasiti Besar 最大容量

500_{mL}

Net Weight
Berat Bersih 淨重

1.1_{kg}



CL102D

Suction Power
Kuasa Sedutan 吸力

14_w

Large Capacity
Kapasiti Besar 最大容量

500_{mL}

Net Weight
Berat Bersih 淨重

1.1_{kg}



BUILT-IN
LITHIUM-ION
BATTERY

**CL104D
CL105D**

Suction Power
Kuasa Sedutan 吸力

20_w

Large Capacity
Kapasiti Besar 最大容量

500_{mL}

Net Weight
Berat Bersih 淨重

1.1_{kg}



Cordless
Tenggali Tanpa Kabel

LED Flashlight
Lampu Suis LED
LECO0302

Vacuum Cleaner
Penisih Vakuum
VAC001

Drilling / Fastening
Druai / Pasak
DR01 / DR02

Impact Drilling / Demolition
Druai / Perusak
DR03 / DR04

Cutting
Pemotong
CU01

Grinding / Sanding
Pangkil / Hakis
GR01 / GR02

Sawing
Gergaji
SA01

Planing / Routing
Pangkil / Tenggan
PL01 / PL02

Others
Lain-lain
LAIN

Outdoor Power Equipment
Alatan Kuasa Luar
AL01 - AL06



* All list price shown are for reference only (exclude SST).
* Semua harga yang ditunjukkan adalah untuk rujukan sahaja (tidak termasuk SST). 所有显示的建议零售价仅供参考 (不包括SST)。



Cordless Cleaner

Pembersih Vakum Tanpa Kord 充电式便携吸尘器

Cordless
Tanpa Kord 无线式

LED Flashlight
Lampu Kerja LED
LED工作灯

Vacuum Cleaner
Pembersih Vakum
吸尘器

Drilling / Fastening
Drill / Pengikat
钻 / 紧固

Impact Drilling / Demolition
Giriul / Perusak
冲击钻 / 拆除加工

Cutting
Pemotong
切割

Grinding / Sanding
Pengam / Pasiran
磨削 / 打磨

Sawing
Gergaji
锯切

Planing / Routing
Pengam / Tropezan
刨削 / 雕刻

Others
Lain-lain
其他

Outdoor Power Equipment
Alatan Kuasa Luar
户外动力设备

Makita
191111

One touch push button switch

Suis butang tekan satu-sentuhan
一键式按钮开关

LED job light
Lampu kerja LED
LED工作灯

*Masa Penggunaan Berterusan
连续使用时间

Continuous Usage Time with BL1830B (Normal Speed)

50min
(approx.)

* Continuous Usage Time/ Work Amount: Actual performance may vary based on application.
Masa Penggunaan Berterusan/ Jumlah Kerja: Prestasi sebenar mungkin berbeza mengikut aplikasi.
连续使用时间/ 工作量: 实际表现可能会因应用而异。

Dust Capacity
Kapasiti Habuk 集尘容量

750mL

Suction Power
Kuasa Sedutan 吸力

Max: 60w

New internal construction prevents loose installation of filter/ paper dust bag to protect the motor room from dust

Melindungi motor dari habuk dengan struktur dalaman baru yang mengelakkan kelonggaran pemasangan beg debu dan penapis kertas. 新的内部结构可防止过滤器/纸尘袋松动安装, 以保护机壳免受灰尘影响

HEPA filter is available (Optional Accessories)



Pipe lock
Pipe is fixed with the locking mechanism to prevent it from accidentally coming off
Paip dengan mekanisme pengunci untuk mengelakkan ketanggalan yang tidak disengajakan
管道通过锁定机构固定, 以防止其意外脱落

DCL281FZW RM 823	DCL281FZB RM 823	DCL281FZ RM 823
----------------------------	----------------------------	---------------------------

Cordless Cleaner
Pembersih Vakum Tanpa Kord
充电式便携吸尘器

• Increased suction power achieved by using highly efficient BL motor

Standard Equipment: Floor Nozzle, Sash Nozzle, Sash Nozzle Holder, Pipe, Stay

- ZW: Without Charger & Battery (White)
- ZB: Without Charger & Battery (Black)
- Z: Without Charger & Battery (Blue)

BL MOTOR

Capacity Kapasiti 容量	750mL
Max Air Flow Aliran Udara 最大空气流量	1.5m³/min
Max Sealed Suction (water column) Sedutan Terkedap (Turus Air) 最大密封吸力(水柱)	8.2kPa (820mmH ₂ O)
Suction Power Kuasa Sedutan 吸力	Max: 60W High: 45W Normal: 15W with Normal Filter Max: 55W High: 40W Normal: 13W with Easy Shake Off Filter
Dimensions (L x W x H) Dimensi 体积	1,016x113x154mm (40"x4-7/16"x6-1/6")
Net Weight Berat Bersih 淨重	1.2 - 1.6kg (2.7 - 3.5lbs.)
Continuous Usage Time (approx.) Masa Penggunaan Berterusan 连续使用时间	Max: 25 min High: 33 min Normal: 83 min with BL1850B

DCL280FZW RM 700	DCL280FZB RM 700	DCL280FZ RM 700
----------------------------	----------------------------	---------------------------

Cordless Cleaner
Pembersih Vakum Tanpa Kord
充电式便携吸尘器

• Increased suction power achieved by using highly efficient BL motor

Standard Equipment: Floor Nozzle, Sash Nozzle, Sash Nozzle Holder, Pipe, Prefilter, Filter H Set (HEPA Filter)

- ZW: Without Charger & Battery (White)
- ZB: Without Charger & Battery (Black)
- Z: Without Charger & Battery (Blue)

BL MOTOR

NEW BARU 新

Capacity Kapasiti 容量	750mL
Max Air Flow Aliran Udara 最大空气流量	1.4m³/min
Max Sealed Suction (water column) Sedutan Terkedap (Turus Air) 最大密封吸力(水柱)	6.4kPa (640mmH ₂ O)
Suction Power Kuasa Sedutan 吸力	Normal Filter: 45W Easy Shake Off Filter: 40W
Dimensions (L x W x H) Dimensi 体积	1,016x113x154mm (40"x4-7/16"x6-1/6")
Net Weight Berat Bersih 淨重	1.2 - 1.6kg (2.7 - 3.5lbs.)
Continuous Usage Time (approx.) Masa Penggunaan Berterusan 连续使用时间	33 min with BL1850B

* All list price shown are for reference only (exclude SST).

* Semua harga yang ditunjukkan adalah untuk rujukan sahaja (tidak termasuk SST). 所有显示的建议零售价仅供参考 (不包括SST)。



Li-ion Ah 6.0 | 5.0 | 4.0 | 3.0 | 2.0 | 1.5

DCL181FZW

RM 632

Cordless Cleaner

Pembersih Vakum Tanpa Kord
充电式便携吸尘器



- Strong suction power for fast cleaning with more run time

Standard Equipment: Floor Nozzle, Sash Nozzle, Sash Nozzle Holder, Pipe, Filter, Prefilter, Stay

- ZWX: Without Charger & Battery (White)



Capacity Kapasiti 容量	650mL
Max Air Flow Aliran Udara 最大空气流量	1.4m³/min
Max Sealed Suction (water column) Sedutan Terkedap (Turus Air) 最大密封吸力(水柱)	5.3kPa (540mmH ₂ O)
Suction Power Kuasa Sedutan 吸力	High: 30W Low: 11W
Dimensions (L x W x H) Dimensi 体积	999x114x152mm (39-1/4"x4-1/2"x6")
Net Weight Berat Bersih 净重	1.2 - 1.4kg (2.7 - 3.1lbs.)
Continuous Usage Time (approx.) Masa Penggunaan Berterusan 连续使用时间	Low: 66 min High: 33 min with BL1850B

DCL180FRFW

RM 1,143

DCL180RFB

RM 1,143

DCL180ZB

RM 487

DCL180Z

RM 487

Cordless Cleaner

Pembersih Vakum Tanpa Kord
充电式便携吸尘器

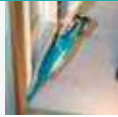

DCL180FRFW



- Strong suction power for fast cleaning

Standard Equipment:
FRFW: Floor Nozzle, Sash Nozzle, Sash Nozzle Holder, Pipe, Stay, Easy Shake Off Filter
RFB / ZB / Z: Floor Nozzle, Sash Nozzle, Sash Nozzle Holder, Pipe, Stay, Filter, Prefilter

- FRFW: 1x Rapid Charger, 1x 3.0Ah Battery (White)
- RFB: 1x Rapid Charger, 1x 3.0Ah Battery (Black)
- ZB: Without Charger & Battery (Black)
- Z: Without Charger & Battery (Blue)

Only for DCL180FRFW



DCL180



VIDEO CLIP
Models and specs may vary by country

Capacity Kapasiti 容量	650mL
Max Air Flow Aliran Udara 最大空气流量	1.4m³/min
Max Sealed Suction (water column) Sedutan Terkedap (Turus Air) 最大密封吸力(水柱)	4.2kPa (428mmH ₂ O)
Suction Power Kuasa Sedutan 吸力	30W
Dimensions (L x W x H) Dimensi 体积	999x114x152mm (39-1/4"x4-1/2"x6")
Net Weight Berat Bersih 净重	1.2kg (2.7 lbs)
Continuous Usage Time (approx.) Masa Penggunaan Berterusan 连续使用时间	33 min with BL1850B

DCL182FRFW

RM 1,305

DCL182FZW

RM 648

Cordless Cleaner

Pembersih Vakum Tanpa Kord
充电式便携吸尘器



- Improved front cover opens with push button for easier access

Standard Equipment: Floor Nozzle, Sash Nozzle, Sash Nozzle Holder, Pipe, Dust Bag, Paper Dust Bag Spcs

- FRFW: 1x Rapid Charger, 1x 3.0Ah Battery (White)
- FZW: Without Charger & Battery (White)

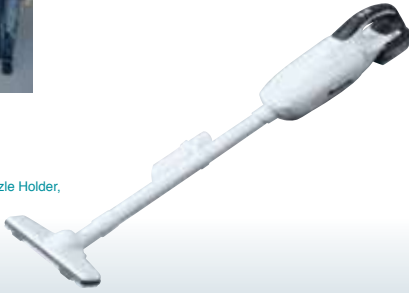

Capacity Kapasiti 容量	Dust Bag: 500mL Paper Pack: 330mL
Max Air Flow Aliran Udara 最大空气流量	1.4m³/min
Max Sealed Suction (water column) Sedutan Terkedap (Turus Air) 最大密封吸力(水柱)	5.4kPa (551mmH ₂ O)
Suction Power Kuasa Sedutan 吸力	High: 30W Low: 11W
Dimensions (L x W x H) Dimensi 体积	1,004x115x151mm (39-1/2"x4-1/2"x5-15/16")
Net Weight Berat Bersih 净重	1.3kg (2.8 lbs)
Continuous Usage Time (approx.) Masa Penggunaan Berterusan 连续使用时间	Low: 66 min High: 33 min with BL1850B

DVC750LZ

RM 1,507

DVC750LZX1

RM 1,532

Cordless Portable Vacuum Cleaner

Pembersih Vakum Tanpa Kord
充电式轻便吸尘器



- Two tools in one; quickly converts from vacuum to blower for increased versatility

Standard Equipment: Hose, Wide Nozzle, Sash Nozzle

- Z: Without Charger & Battery
- ZX1: 1x Shoulder Belt, Without Charger & Battery



DVC750



VIDEO CLIP
Models and specs may vary by country



Capacity Kapasiti 容量	Dust: 7.5L
Max Air Flow Aliran Udara 最大空气流量	High: 1.6m³/min Normal: 1.3m³/min
Max Sealed Suction Sedutan Terkedap (Turus Air) 最大密封吸力(水柱)	High: 6.7kPa Normal: 4.2kPa
Suction Power Kuasa Sedutan 吸力	High: 50W Normal: 25W
Dimensions (L x W x H) Dimensi 体积	418x251x278mm (16-1/2"x9-7/8"x11")
Net Weight Berat Bersih 净重	4.3 - 4.6kg (9.4 - 10.1 lbs.)
Continuous Usage Time (approx.) Masa Penggunaan Berterusan 连续使用时间	Normal: 60 min High: 30 min with BL1850B

DVC350Z

RM 1,808

Cordless Vacuum Cleaner

Pembersih Vakum Tanpa Kord
充电式吸尘器



- Large 3L dust bag capacity

Standard Equipment: Nozzle assembly, Dust Bag Assembly, Hose, Shoulder Belt

- Z: Without Charger & Battery



Max Peak Air Flow Aliran Udara 最大空气流量	3.4m³/min
Max Sealed Suction (water column) Sedutan Terkedap (Turus Air) 最大密封吸力(水柱)	5.5kPa (560mmH ₂ O)
Recoverable Capacity Kapasiti 容量	Dust: 3L
Dimensions (L x W x H) Dimensi 体积	273x195x226mm (10-3/4"x7-5/8"x8-7/8")
Net Weight Berat Bersih 净重	2.2kg (4.8lbs)
Continuous Usage Time (approx.) Masa Penggunaan Berterusan 连续使用时间	Low: 43 min High: 22 min with BL1850B



DVC350/DVC260



VIDEO CLIP
Models and specs may vary by country

* All list price shown are for reference only (exclude SST).

* Semua harga yang ditunjukkan adalah untuk rujukan sahaja (tidak termasuk SST). 所有显示的建议零售价仅供参考 (不包括SST)。

12V_{max}

CXT

Li-ion Ah 4.0 2.0 1.5

Cordless Cleaner

Pembersih Vakum Tanpa Kord 充电式吸尘器

Mat Nozzle 120



Seat Nozzle 120



Rubber Nozzle 330



Soft Brush 360



Blower Nozzle



CL121DZ

RM 965

Cordless Cleaner
Pembersih Vakum Tanpa Kord
充电式吸尘器



- Comes with a variety of special nozzles optimum for cleaning car interior

Standard Equipment: Mat Nozzle, Seat Nozzle, Rubber Nozzle, Soft Brush, Blower Nozzle, Dust Bag, Paper Dust Bag 5pcs (194566-1), Shoulder Belt

- Z: Without Charger & Battery



Capacity Kapasiti 容量	Dust Bag: 500mL Paper Pack: 330mL
Max Air Flow Aliran Udara 最大空气流量	1.3m ³ /min
Max Sealed Suction (water column) Sedutan Terkedap (Turus Air) 最大密封吸力(水柱)	4.6kPa (470 mmH ₂ O)
Suction Power Kuasa Sedutan 吸力	Max: 28W High: 19W Normal: 5W
Dimensions (L x W x H) Dimensi 体积	345x138x202mm (13-5/8"x5-7/16"x8")
Net Weight Berat Bersih 净重	1.7 - 1.8kg (3.7 - 4.0lbs.)
Continuous Usage Time (approx.) Masa Penggunaan Berterusan 连续使用时间	Normal: 33 min High: 16 min Max: 13 min with BL1021B

CL108FDWYW | CL108FDZW

RM 937

RM 582

Cordless Cleaner
Pembersih Vakum Tanpa Kord
充电式便携吸尘器



- Compact and High Suction Power

Standard Equipment: Floor Nozzle, Sash Nozzle, Sash Nozzle Holder, Pipe, Filter, Prefilter

- WYW: 1x Standard Charger, 1x 1.5Ah Battery (White)
- ZW: Without Charger & Battery (White)



Capacity Kapasiti 容量	600mL
Max Air Flow Aliran Udara 最大空气流量	1.2m ³ /min
Max Sealed Suction (water column) Sedutan Terkedap (Turus Air) 最大密封吸力(水柱)	4.4kPa (445mmH ₂ O)
Suction Power Kuasa Sedutan 吸力	Max: 30W High: 20W Normal: 5W
Dimensions (L x W x H) Dimensi 体积	956x110x150mm (37-5/8"x4-5/16"x5-7/8")
Net Weight Berat Bersih 净重	1.0 - 1.2kg (2.3 - 2.7lbs.)
Continuous Usage Time (approx.) Masa Penggunaan Berterusan 连续使用时间	Normal: 33 min High: 16 min Max: 13 min with BL1021B

CL106FDWYW | CL106FDZW

RM 820

RM 465

Cordless Cleaner
Pembersih Vakum Tanpa Kord
充电式便携吸尘器

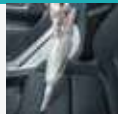

- Stronger suction power for faster cleaning with more run time

Standard Equipment: Floor Nozzle, Sash Nozzle, Sash Nozzle Holder, Pipe, Filter, Prefilter

- WYW: 1x Standard Charger, 1x 1.5Ah Battery (White)
- ZW: Without Charger & Battery (White)



Capacity Kapasiti 容量	600mL
Max Air Flow Aliran Udara 最大空气流量	1.3m ³ /min
Max Sealed Suction (water column) Sedutan Terkedap (Turus Air) 最大密封吸力(水柱)	3.1kPa (316mmH ₂ O)
Suction Power Kuasa Sedutan 吸力	19W
Dimensions (L x W x H) Dimensi 体积	958x100x150mm (37-3/4"x4-3/8"x5-7/8")
Net Weight Berat Bersih 净重	1.0kg (2.2 lbs.)
Continuous Usage Time (approx.) Masa Penggunaan Berterusan 连续使用时间	21 min with BL1021B

CL107FDWYW | CL107FDZW

RM 982

RM 628

Cordless Cleaner
Pembersih Vakum Tanpa Kord
充电式便携吸尘器



- 3 mode suction power settings

Standard Equipment: Floor Nozzle, Sash Nozzle, Sash Nozzle Holder, Pipe, Dust Bag, Paper Dust Bag 5pcs (194566-1)

- WYW: 1x Standard Charger, 1x 1.5Ah Battery (White)
- ZW: Without Charger & Battery (White)



Capacity Kapasiti 容量	Dust Bag: 500mL Paper Pack: 330mL
Max Air Flow Aliran Udara 最大空气流量	1.4m ³ /min
Max Sealed Suction (water column) Sedutan Terkedap (Turus Air) 最大密封吸力(水柱)	5.0kPa (510mmH ₂ O)
Suction Power Kuasa Sedutan 吸力	Max: 32W High: 20W Normal: 5W
Dimensions (L x W x H) Dimensi 体积	960x112x150mm (37-3/4"x4-3/8"x5-7/8")
Net Weight Berat Bersih 净重	1.1kg (2.5lbs.)
Continuous Usage Time (approx.) Masa Penggunaan Berterusan 连续使用时间	Normal: 25 min High: 12 min Max: 10 min with BL1021B

* All list price shown are for reference only (exclude SST).

* Semua harga yang ditunjukkan adalah untuk rujukan sahaja (tidak termasuk SST). 所有显示的建议零售价仅供参考 (不包括SST)。

Cordless
Tanpa Kord 无线

LED Flashlight
Lampu Flash LED
LED 闪光灯

Vacuum Cleaner
Pembersih Vakum
吸尘器

Drilling / Fastening
Dremel / Pengikat
电钻 / 螺絲

Impact Drilling / Demolition
Giling / Perusak
电钻 / 拆墙工具

Cutting
Memotong
切割

Grinding / Sanding
Pangkas / Pasir
打磨 / 砂纸

Sawing
Gergaji
电锯

Planing / Routing
Pencetakan / Pengisian
刨花 / 雕刻

Others
Lain-lain
其他

Outdoor Power Equipment
Alatan Kuasa Luar
户外工具





CL100DW | CL100DZ
RM 623 | RM 278

Cordless Cleaner
Pembersih Vakum Tanpa Kord
充电式便携吸尘器



- Increased storage capacity for longer time between waste disposal

Standard Equipment: Floor Nozzle, Sash Nozzle, Sash Nozzle Holder, Pipe, Filter, Prefilter

- W: 1x Standard Charger, 1x 1.3Ah Battery (White)
- Z: Without Charger & Battery (White)



Capacity Kapasiti 容量	600mL
Max Air Flow Aliran Udara 最大空气流量	1.3m ³ /min
Max Sealed Suction (water column) Sedutan Terkedap (Turus Air) 最大密封吸力(水柱)	2.3kPa (235mmH ₂ O)
Suction Power Kuasa Sedutan 吸力	14W
Dimensions (L x W x H) Dimensi 体积	966x103x150mm (38-1/32"x4-1/16"x5-7/8")
Net Weight Berat Bersih 净重	0.88kg (1.94lbs)
Continuous Usage Time (approx.) Masa Penggunaan Berterusan 连续使用时间	12 min with BL1013

CL102DW | CL102DZ
RM 752 | RM 428

Cordless Cleaner
Pembersih Vakum Tanpa Kord
充电式便携吸尘器



- Quick clean-ups with strong suction power

Standard Equipment: Floor Nozzle, Sash Nozzle, Sash Nozzle Holder, Pipe, Dust Bag, Paper Dust Bag 5pcs

- W: 1x Standard Charger, 1x 1.3Ah Battery (White)
- Z: Without Charger & Battery (White)

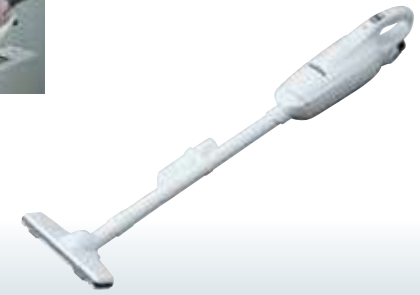

Capacity Kapasiti 容量	Dust Bag: 500mL Paper Pack: 330mL
Max Air Flow Aliran Udara 最大空气流量	1.1m ³ /min
Max Sealed Suction (water column) Sedutan Terkedap (Turus Air) 最大密封吸力(水柱)	2.7kPa (275mmH ₂ O)
Suction Power Kuasa Sedutan 吸力	High: 14W Low: 6W
Dimensions (L x W x H) Dimensi 体积	984x113x150mm (38-3/4"x4-7/16"x5-7/8")
Net Weight Berat Bersih 净重	1.1kg (2.4lbs)
Continuous Usage Time (approx.) Masa Penggunaan Berterusan 连续使用时间	Low: 21 min High: 13 min with BL1013

CL111DWI | CL111DWR
RM 895 | RM 895

Cordless Cleaner
Pembersih Vakum Tanpa Kord
充电式便携吸尘器



With Built-in Battery
Dengan Bateri Terbina Dalam
内置电池

- LED light indicates when to charge battery

Standard Equipment: Nozzle for Flooring & Carpet, Sash Nozzle, Sash Nozzle Holder, Pipe, Adapter

- WI (Ivory): 1x Standard Charger, Built-in 1.5Ah Battery, Dust Bag, Paper Dust Bag 5pcs
- WR (Red): 1x Standard Charger, Built-in 1.5Ah Battery, Filter, Prefilter

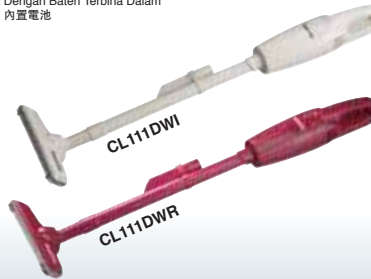

Capacity Kapasiti 容量	560mL
Max Air Flow Aliran Udara 最大空气流量	1.4m ³ /min
Max Sealed Suction (water column) Sedutan Terkedap (Turus Air) 最大密封吸力(水柱)	3.4kPa (350mmH ₂ O)
Suction Power Kuasa Sedutan 吸力	21W
Dimensions (L x W x H) Dimensi 体积	906x102x109mm (35-3/4"x4"x4-1/4")
Net Weight Berat Bersih 净重	0.94kg (2.1lbs.)
Continuous Usage Time (approx.) Masa Penggunaan Berterusan 连续使用时间	12 min with Built-in Lithium-ion Battery

CL104DWYX | CL104DWY
RM 590 | RM 590

Cordless Cleaner
Pembersih Vakum Tanpa Kord
充电式便携吸尘器

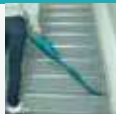

With Built-in Battery
Dengan Bateri Terbina Dalam
内置电池

- Increased storage capacity for longer time between waste disposal

Standard Equipment: Floor Nozzle, Sash Nozzle, Sash Nozzle Holder, Pipe, Dust Bag, Adapter (DC1001), Paper Dust Bag 5pcs (194566-1)

- WYX: 1x Standard Charger, Built-in 1.5Ah Battery (Blue)
- WY: 1x Standard Charger, Built-in 1.5Ah Battery (White)

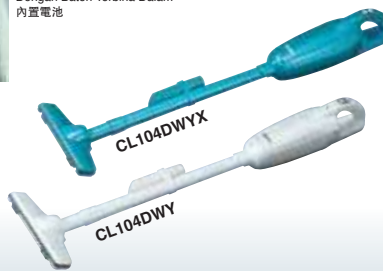

Capacity Kapasiti 容量	Dust Bag: 500mL Paper Pack: 330mL
Max Air Flow Aliran Udara 最大空气流量	1.1m ³ /min
Max Sealed Suction (water column) Sedutan Terkedap (Turus Air) 最大密封吸力(水柱)	3.3kPa (340mmH ₂ O)
Suction Power Kuasa Sedutan 吸力	Turbo: 20W High: 14W Low: 5W
Dimensions (L x W x H) Dimensi 体积	983x113x136mm (38-3/4"x4-7/16"x5-3/8")
Net Weight Berat Bersih 净重	1.1kg (2.3lbs)
Continuous Usage Time (approx.) Masa Penggunaan Berterusan 连续使用时间	Low: 30 min High: 15 min Turbo: 10 min with Built-in Lithium-ion Battery

CL105DW | CL105DWX
RM 570 | RM 570

Cordless Cleaner
Pembersih Vakum Tanpa Kord
充电式便携吸尘器



With Built-in Battery
Dengan Bateri Terbina Dalam
内置电池

- Strong suction power of 20W

Standard Equipment: Floor Nozzle, Sash Nozzle, Sash Nozzle Holder, Pipe, Dust Bag, Adapter (DC1001), Paper Dust Bag 5pcs (194566-1)

- W: 1x Standard Charger, Built-in 1.3Ah Battery (White)
- WX: 1x Standard Charger, Built-in 1.3Ah Battery (Blue)

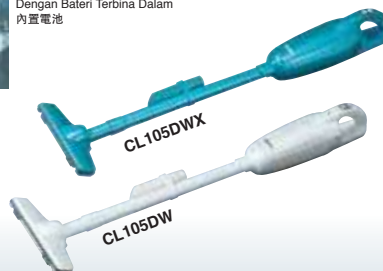

Capacity Kapasiti 容量	Dust Bag: 500mL Paper Pack: 330mL
Max Air Flow Aliran Udara 最大空气流量	1.1m ³ /min
Max Sealed Suction (water column) Sedutan Terkedap (Turus Air) 最大密封吸力(水柱)	3.3kPa (340mmH ₂ O)
Suction Power Kuasa Sedutan 吸力	Turbo: 20W High: 14W Low: 5W
Dimensions (L x W x H) Dimensi 体积	983x113x136mm (38-3/4"x4-7/16"x5-3/8")
Net Weight Berat Bersih 净重	1.1kg (2.3lbs)
Continuous Usage Time (approx.) Masa Penggunaan Berterusan 连续使用时间	Low: 20 min High: 10 min Turbo: 7 min with Built-in Lithium-ion Battery

* All list price shown are for reference only (exclude SST).

* Semua harga yang ditunjukkan adalah untuk rujukan sahaja (tidak termasuk SST). 所有显示的建议零售价仅供参考 (不包括SST)。

Cordless
Tempat Kord 无线

LED Flashlight
Lampu Sash LED
LECOB002

Vacuum Cleaner
Penbaskh Vakum
吸尘器

Drilling / Fastening
Gantuk / Pasang
钻 / 紧固

Impact Drilling / Demolition
Gantuk / Pencah
打 / 拆除

Cutting
Pemotong
切割

Grinding / Sanding
Pencikil / Hala
磨 / 打磨

Sawing
Gergaji
锯切

Planing / Routing
Pogolan / Tanggan
刨 / 压花

Others
Lain-lain
其他

Outdoor Power Equipment
Alatan Kuasa Luar
户外动力设备

Thakita
TINTA

Cordless Cleaner

Pembersih Vakum Tanpa Kord 充电式吸尘器

7.2V

Li-ion Ah 1.5

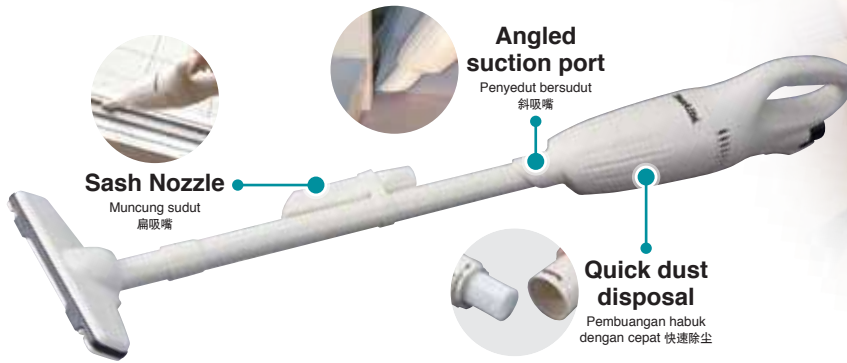

CL070DZ

RM 263

Cordless Cleaner

Pembersih Vakum Tanpa Kord
充电式便携吸尘器



- Increased storage capacity for longer time between waste disposal



Standard Equipment: Floor Nozzle, Sash Nozzle, Sash Nozzle Holder, Pipe, Filter, Prefilter

• Z: Without Charger & Battery (White)

Capacity Kapasiti 容量	600mL
Max Air Flow Aliran Udara 最大空气流量	1.2m ³ /min
Max Sealed Suction (water column) Sedutan Terkedap (Turus Air) 最大密封吸力(水柱)	1.8kPa (180mmH ₂ O)
Suction Power Kuasa Sedutan 吸力	14W
Dimensions (L x W x H) Dimensi 体积	966x103x142mm (38-1/32"x4-1/16"x5-5/8")
Net Weight Berat Bersih 净重	0.81kg (1.8lbs)
Continuous Usage Time (approx.) Masa Penggunaan Berterusan 连续使用时间	8 min with BL7010

Cordless Cleaner

Pembersih Vakum Tanpa Kord 充电式吸尘器

18V

G-Battery

Li-ion Ah 1.3

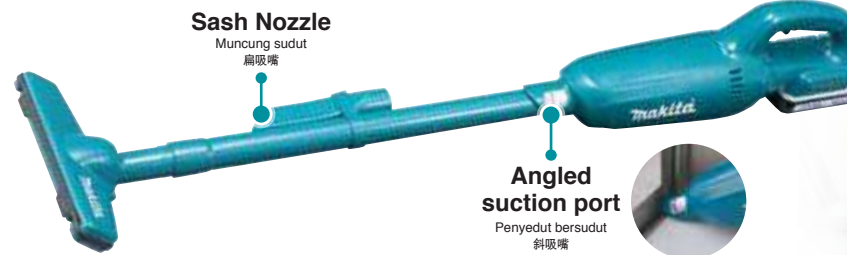

CL183DZX

RM 272

Cordless Cleaner

Pembersih Vakum Tanpa Kord
充电式便携吸尘器



- Compact and lightweight design



Standard Equipment: Floor Nozzle, Sash Nozzle, Sash Nozzle Holder, Pipe, Filter, Prefilter

• ZX: Without Charger & Battery

Capacity Kapasiti 容量	600mL
Max Air Flow Aliran Udara 最大空气流量	1.3m ³ /min
Max Sealed Suction (water column) Sedutan Terkedap (Turus Air) 最大密封吸力(水柱)	2.6kPa (270mmH ₂ O)
Suction Power Kuasa Sedutan 吸力	17W
Dimensions (L x W x H) Dimensi 体积	966x102x148mm (38"x4"x5-7/8")
Net Weight Berat Bersih 净重	1.2kg (2.6lbs.)
Continuous Usage Time (approx.) Masa Penggunaan Berterusan 连续使用时间	30 min with BL1815G

* All list price shown are for reference only (exclude SST).

* Semua harga yang ditunjukkan adalah untuk rujukan sahaja (tidak termasuk SST). 所有显示的建议零售价仅供参考 (不包括SST)。

Centrifugal force separates fine dust, allowing the main unit of the cleaner to require about 80% less frequent dust disposal

Daya sentrifugal memisahkan debu halus, mengurangkan kekerapan pembersihan penapis kira-kira 80%
 离心力将细小的灰尘分开, 使清洁器的主机减少了大约80%的频繁灰尘处理



Cyclone pre-separation system separates dust from air

Sistem pra-pemisahan siklon memisahkan debu dari udara
 旋风分离系统将灰尘与空气隔离



Dust case

Easy disposal of the fine dust collected in dust case

Debu halus dikumpulkan dalam pengumpul habuk mudah dibersihkan
 集尘箱中收集的细粉尘方便处理



The main unit of the cleaner requires much less frequent dust disposal

Mangurangkan kekerapan pembersihan pengumpul habuk
 减少清空集尘箱频率

Cyclone Attachment Set

Set Pengumpul Habuk Siklon 旋风集尘配件

Pipe lock

DCL280F, DCL281F, DCL282F

Part No.191D71-3 (White)
 Part No.191D73-9 (Black)



Dust capacity **400mL** / Net weight **0.36kg**

CL106FD, CL107FD, CL108FD, DCL180, DCL181F, DCL182, CL183D

Part No.199491-1 (White)
 Part No.191D75-5 (Black)



Dust capacity **400mL** / Net weight **0.35kg**

Easily fitting

Mudah dipasang 轻松拟合



With short pipe (Part No.191D76-3)



With short pipe (Part No.191D79-7)

Without standard pipe (Part No.451241-5)



By using this short pipe when attaching Cyclone attachment, you can use the cleaner with the same overall length as the cleaner without Cyclone attachment

Dengan menggunakan paip pendek ini apabila bersambung dengan set pengumpul habuk siklon, anda boleh menggunakan pembersih dengan panjang keseluruhan yang sama seperti pembersih tanpa set pengumpul habuk siklon
 安装旋风集尘配件时使用此短管, 可以使吸尘机的总长度与不安装旋风集尘配件的吸尘机相同

Pipe lock DCL280F, DCL281F, DCL282F

Pipe is fixed with the locking mechanism to prevent it from accidentally coming off

Paip dengan mekanisme penguncian untuk mengelakkannya dari jatuh tanpa sengaja 管锁固定以防止意外脱落



Pipe with beveled end

Cleaning of tight places can be done without nozzle by using the beveled end of pipe as a nozzle

Paip serong bertindak sebagai muncung untuk membersihkan kawasan sempit
 倒角管的倾斜端作为喷嘴可以清洁狭窄的地方



Suction Power Keep

90%*

*When used with DCL182 (wood dust)

Cordless
 Tanpa Kabel 无线

LED Flashlight
 Lampu Suhu LED
 LED 闪光灯

Vacuum Cleaner
 Pengisap Vakuum
 吸尘器

Drilling / Fastening
 Gergaji / Pengikat
 电钻 / 紧固

Impact Drilling / Demolition
 Gergaji / Hancurkan
 电钻 / 破坏

Cutting
 Pemotong
 切割

Grinding / Sanding
 Pengisar / Hala
 打磨 / 砂磨

Sanding
 Gergaji
 打磨

Planing / Routing
 Pengisar / Tanggan
 打磨 / 刨花

Others
 Lain-lain
 其他

Outdoor Power Equipment
 Alatan Kuasa Luar
 户外动力设备

Thakita
 1111111111

For Cleaning



Model
DVC340 / DVC350 /
DVC860L / DVC861L /
DVC862L / DVC863L



Model
DVC261 / DVC265



Hose 38mm-1.5m
with front sleeve

Hose 32mm
with front sleeve
1m, 1.7m

Hose 28mm
without front sleeve
1m, 1.5m

Front cuffs 22

See page P226

Hose 38mm
1.5m

Bending pipe assembly
For aluminum straight pipe with lock
*with Hose 28 sleeve

Bending pipe assembly
For plastic straight pipe
*with Hose 28 sleeve

Bending pipe **Straight pipe**

Aluminum Telescopic pipe assembly
Pipe length is variably adjustable from 590 to 942mm.

Plastic Telescopic pipe assembly
Pipe length is variably adjustable from 500 to 850mm.

Tapered nozzle set

Nozzle assembly 28
Flat type

F/C switching T-nozzle 28

Floor/carpet T-nozzle

Floor T-nozzle 28

Flexible rubber nozzle

Tapered nozzle set

Nozzle assembly 38
Flat type

F/C switching T-nozzle 38

Universal Type Nozzle assembly 38

Compact Type

Round brush

Corner nozzle

Seat nozzle 28

Corner nozzle 300-28

Crevice nozzle 415

Round brush

Shelf brush

Cordless Cleaner System charts

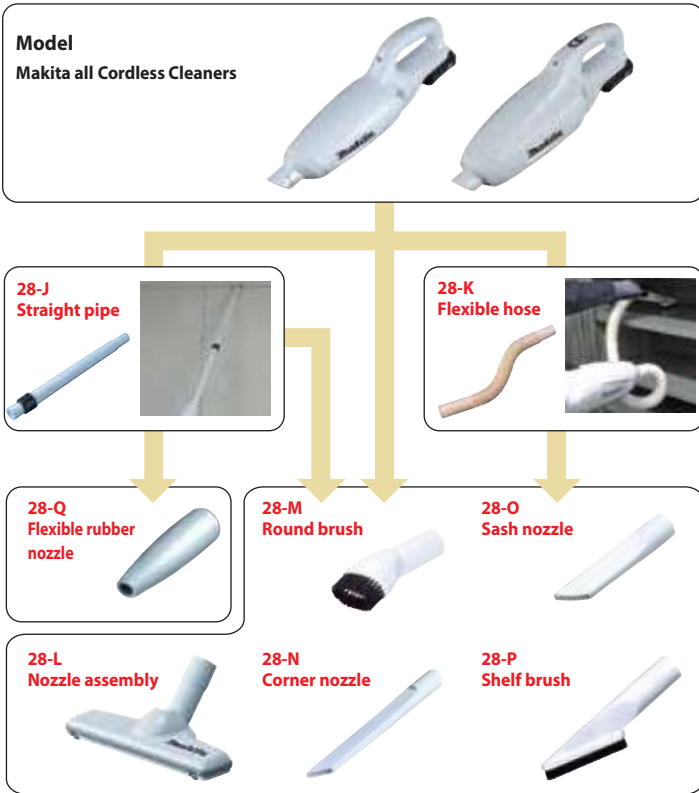

For Dust Collecting

See page P216

<p>W/ Ø28mm Hose Model DVC350 / DVC861L DVC863L / DVC864L</p>	<p>W/ Ø38mm Hose Model DVC860L / DVC861L DVC862L / DVC863L DVC750L</p>	<p>W/ Ø28mm Hose Model DVC261 / DVC265</p>
<p>W/ Front cuffs 38 24 22</p>	<p>W/ Joint 22-38</p>	<p>W/ Front cuffs 38 24 22</p>



For Cordless Cleaner 28-J Straight pipe



Description	Color	Part No.	EU
			Part No.
Aluminum Telescopic pipe assembly Pipe length is variably adjustable from 590 to 942mm.	Aluminum	140G19-0	-
Telescopic pipe assembly 28 Pipe length is variably adjustable from 500 to 850mm.	White	198559-0	198560-5
Plastic straight pipe 28	Ivory	451424-7	-
	White	451241-5	-
	Blue	451244-9	-
	Red	451425-5	-
	Pink	457231-6	-
	Black	456587-4	-

28-K Flexible hose set28



Description	Color	Part No.	EU
			Part No.
Flexible hose set28 Superior in flexibility and for the cleaning of the small place in the car	Ivory	191496-7	198544-3
	White	198867-9	198868-7
	Blue	198541-9	198545-1
	Red	198542-7	198546-9
	Pink	198870-0	198871-8
	Black	198543-5	198547-7

28-L Nozzle assembly Flat type



F/C switching t-nozzle 28

Description	Color	Part No.	EU
			Part No.
Flat type	Black	199454-7	-
F/C switching t-nozzle 28 Flooring & carpet	White	198183-9	198532-0
F/C switching t-nozzle 28 Flooring & carpet	Blue	199431-9	-

Cordless
Temp. Hot / 熱

LED Flashlight
Lamp / 点灯 LED
Lamp / 点灯 LED

Vacuum Cleaner
掃除機 / 掃除機

Drilling / Fastening
ドリル / ビス

Impact Drilling / Demolition
ドリル / 破砕機

Cutting
切断機 / 切断機

Grinding / Sanding
研磨機 / 研磨機

Sawing
切断機 / 切断機

Planing / Routing
削平機 / 削平機

Others
その他 / その他

Outdoor Power Equipment
屋外動力機器 / 屋外動力機器



Cordless
Tansil Hord 08.02.12

LED Flashlight
Lampul Flash LED
LED 03.01.12

Vacuum Cleaner
Pomocnik Vakuu
03.03.12

Drilling / Fastening
Drobit / Pripnati
03.01.12

Impact Drilling / Demolition
Drobit / Demolition
03.03.12

Cutting
Pozivati
03.01.12

Grinding / Sanding
Pozivati / Piskati
03.01.12

Sawing
Drobit
03.01.12

Planing / Routing
Pozivati / Pripnati
03.01.12

Others
03.01.12

Outdoor Power Equipment
Alat-alat Listrik
03.01.12

Makita
03.01.12

Nozzle assembly

Floor/carpet t-nozzle
For rug / carpet cleaning



Description	Color	Part No.	EU
			Part No.
Floor/carpet t-nozzle For rug / carpet cleaning	Ivory	198150-4	198149-9
	White	198525-7	198528-1
	Blue	198523-1	198527-3
	Red	198524-9	198522-3
	Pink	198882-3	198883-1
	Black	198526-5	198529-9

Nozzle assembly

Floor t-nozzle 28



Description	Color	Part No.
Floor t-nozzle 28	Ivory	123485-4
	White	123486-2
	Blue	123488-8
	Red	123489-6
	Pink	123843-4
	Black	123539-7

Nozzle assembly

For rug / carpet cleaning



Description	Color	Part No.	EU
			Part No.
For rug / carpet cleaning	Ivory	122291-4	-

Nozzle assembly

Seat nozzle 28



Description	Color	Part No.	EU
			Part No.
Seat nozzle 28 For car seat	White	199037-3	199038-1
	Blue	199040-4	199041-2
	Black	198921-9	199039-9

28-M

Round brush 28



Color	Part No.	EU
		Part No.
Ivory	198548-5	198552-4
White	198877-6	198878-4
Blue	198549-3	198553-2
Red	198550-8	198554-0
Pink	198880-7	198881-5
Black	198551-6	198555-8

28-N

Corner nozzle 330-28

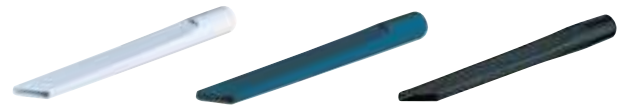

Size	Color	Part No.	EU
			Part No.
330-28mm	White	198918-8	198919-6
	Blue	198989-5	198990-0
	Black	198991-8	198992-6

28-O

Sash nozzle 28 and Long Sash nozzle 415

Sash nozzle 28



Long Sash nozzle 415



Description	Color	Part No.
Sash nozzle 28	Ivory	416041-0
	White	451240-7
	Blue	451243-1
	Red	416225-0
	Pink	457228-5
Crevice nozzle 415 set	Black	456586-6
	White	199439-3

28-P

Shelf brush set 28

(For gentle cleaning by soft-tipped brush)



Color	Part No.	EU	
		Part No.	
Ivory	191724-0	198537-0	
White	198872-6	198873-4	
Blue	198534-6	198538-8	
Red	198535-4	198539-6	
Pink	198875-0	198876-8	
Black	198536-2	198540-1	

28-Q

Flexible rubber nozzle



Color	Part No.	EU	
		Part No.	
gray	197900-4	197901-2	

28-I

Tapered nozzle set

Use with Front cuts 22 or Flexible rubber nozzle



Color	Part No.	EU	
		Part No.	
gray	192236-6	198558-2	

Cordless Cleaner for Capsule type

For Model: CL183D, DCL181F, DCL180, CL111D, CL106FD, CL070D
Filter



Pre filter

Easy shake off dust filter

Description	Per pkg.	Part No.	EU	
			Part No.	
Filter	10	198914-6	198915-4	
Pre filter	1	198750-0	198751-8	
Easy shake off dust filter	1	198752-6	198753-4	

Cordless Cleaner for Paper bag type

For Model: DCL182, CL121D, CL107FD, CL105D, CL104D, CL072D
Paper filter



Dust bag



Easy shake off dust bag

Description	Per pkg.	Part No.	EU	
			Part No.	
Paper filter Anti-bacterial type	10	194565-3	198744-5	
	5	194566-1	198745-3	
Dust bag	1	198746-1	198747-9	
Easy shake off dust bag	1	198748-7	198749-5	

Other Cleaners

For DVC261, DVC265

Dust bag assembly



Filter bag set (Paper dust bag)

Description	Per pkg.	Part No.	EU	
			Part No.	
Dust bag assembly	1	197898-5	197899-3	
Filter bag set (Paper dust bag)	10	197902-0	197903-8	

Hose



Description	Size	Part No.
without front sleeve	28mm-1m	143787-2
without front sleeve	28mm-1.5m	144408-9
with front sleeve	32mm-1.1m	199453-9
with front sleeve	38mm-1.5m	199388-4
with Front cuffs 38, Hose connection 38mm	38mm-1.5m	198757-6

Bending pipe assembly

*with Hose 28 sleeve



Description	Part No.
For Aluminum Telescopic pipe assembly with lock	140G26-3
	*127093-3
For plastic straight pipe 28 and Telescopic pipe assembly 28	458184-2
	*126756-8

Cordless
Temp. Kontrol 0.1°C

LED Flashlight
Lampu Senter LED
LEDC03002

Vacuum Cleaner
Penisbiak Vakuum
03.03.03

Drilling / Fastening
Gergaji / Pasak
03.03.03

Impact Drilling / Demolition
Gergaji / Perusak
03.03.03

Cutting
Pemotong
03.03

Grinding / Sanding
Pergasi / Halus
03.03 / 03.03

Sawing
Gergaji
03.03

Planing / Routing
Perataan / Tenggang
03.03 / 03.03

Others
Lain-lain
03.03

Outdoor Power Equipment
Alat-alat Kerja Luar
03.03 - 03.03

Makita
TIME

Cordless
Tansit Hord 無線式

LED Flashlight
Lampu Flash LED
LED 照度

Vacuum Cleaner
Penisih Vakuüm
吸尘器

Drilling / Fastening
Dremel / Pengikat
钻头 / 螺絲

Impact Drilling / Demolition
Gimbal / Perusak
打釘器 / 拆毀工具

Cutting
Pemotong
切割

Grinding / Sanding
Pengkilan / Pasiran
打磨 / 砂磨

Sawing
Gergaji
鋸

Piercing / Routing
Pencetakan / Pengalihan
鑽孔 / 開槽

Others
Lain-lain
其他

Outdoor Power Equipment
Alatan Kuasa Luar
園林工具



For CL121D

Mat nozzle 120



Seat nozzle 120 complete



Rubber nozzle 330



Soft brush 360 complete



Description	Part No.
Mat nozzle 120	459056-4
Seat nozzle 120 complete	140H95-0
Rubber nozzle 330	422437-5
Soft brush 360 complete	140H94-2

For DRC200

Boundary line tape (15m roll)



Side brushes



Power brush



Turn brush cover



Filter



Description	Part No.
Boundary line tape (15m roll)	SH00000231 (EU)
	SH00000240 (USA, AU)
Side brushes	SH00000065
Power brush	SH00000063
Turn brush cover	SH00000064
Filter	SH00000213

**For DVC350
Dust bag**



Part No.
122918-6

Nozzle assembly



Model No.	Size(mm)	Part No.
DVC350	220	132025-7
	430	134182-7

For DVC750L

Pre filter and Damper

(Dry use only)

Pre filter



Damper



Pre filter and Damper set

Item	Part No.
Pre filter	162635-6
Damper	422449-8
Pre filter and Damper set	199827-4

Quick charger

(AC only)



Model No.	Charging time (min.) (approx.)	Part No.
CL104D, CL105D, CL111D	180	DC1001

For DCL501



	Type	Part No.
Hose	-	SH00000034
Straight pipe	Adjustable length	SH00000060
Nozzle assembly	Flooring & carpet	SH00000058
Crevice nozzle	-	SH00000042

Flexible hose set

(Total length: 95cm)



Model No.	Part No.
DUB142, DUB182, UB1100, UB1101	191750-9
UB1102, UB1103	196643-5

VACUUM CLEANER

Automatic Self-cleaning Filtration System achieved by two filter units

Sistem Penapis Penyucian Automatik 自动清洗过滤系统

Constantly high suction power throughout operation because dust is removed from Prefilters every 10 seconds during operation

Kuasa penyedut yang berterusan sepanjang operasi kerana habuk dikeluarkan dari penapis setiap 10 saat semasa operasi

在整个运行过程中吸力保持在较高的水平，因为在运行过程中，每10秒就会从过滤器中除去灰尘

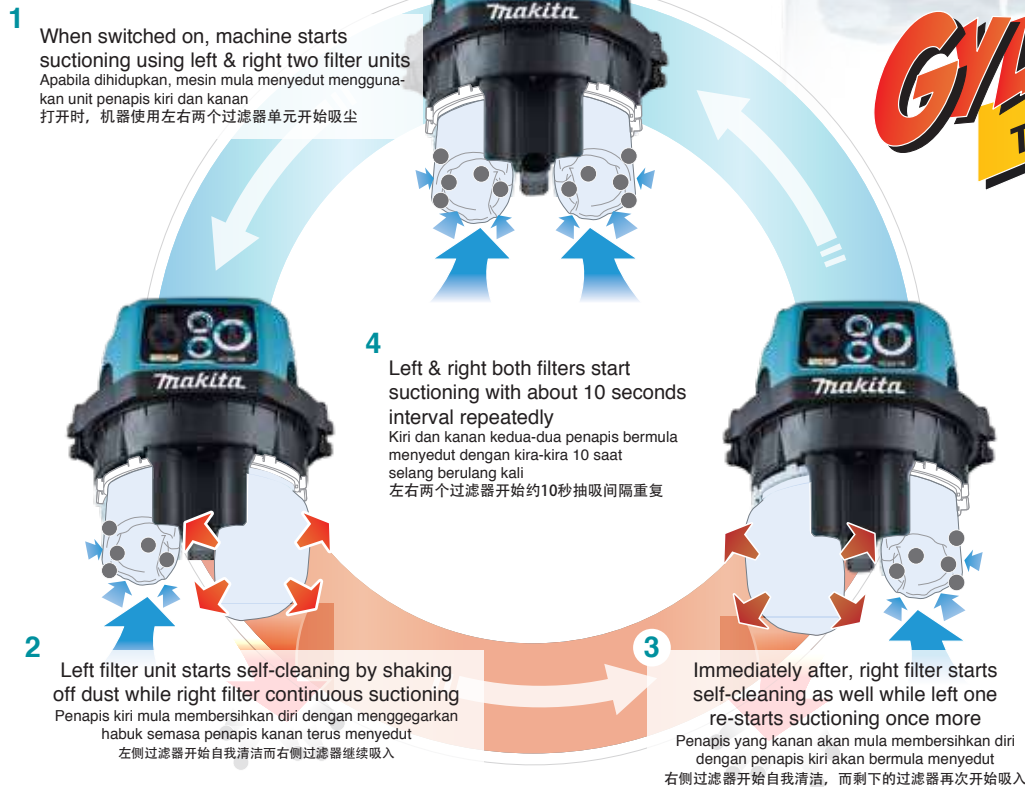

VC3211M

Vacuum Cleaner (Wet & Dry)
Pembersih Vakum (Basah Dan Kering)
吸尘器(干湿两用)

- 32L Large dust bag capacity enables continuous cleaning work
Kapasiti debu 32L besar boleh membersihkan secara berterusan
32L大容量尘袋可延续清洁工作

Standard Equipment: Hose, Holder 10-33, Front Cuffs (22, 24, 38), Cloth Filter, Poly Bag Set 10pcs



Dust Class M
Debu Kelas M | 集尘等级M

WET Basah 湿
DRY Kering 干



AUTOMATIC Self-cleaning Filtration System
Sistem Penapis Penyucian Automatik
自动清洗过滤系统

Continuous Rating Input Kuasa Sedutan 额定输入功率	1,050W
Max Peak Air Flow Aliran Udara 最大空气流量	2.0m ³ /min
Max Sealed Suction (water column) Sedutan Terkedap (Turus Air) 最大密封吸力(水柱)	22.0kPa (2,240 mmH ₂ O)
Tank Capacity Kapasiti 容量	Dust: 32L Water: 27L
Dimensions (L x W x H) Dimensi 体积	552x398x685mm (21-3/4"x15-5/8"x27")
Net Weight Berat Bersih 净重	16.9kg (37.3lbs)
Power Supply Cord Kabel Wayar 电源线	5.0m (16.4ft)

VC2211M

Vacuum Cleaner (Wet & Dry)
Pembersih Vakum (Basah Dan Kering)
吸尘器(干湿两用)

- Approved for Dust Class M in accordance with the EU standard
Diluluskan oleh piawaian EU untuk menyedut debu kelas M
依欧盟标准，集尘等级M

Standard Equipment: Hose, Front Cuffs (22, 24, 38), Belt Hook, Hose Band, Cap, Poly bag 800x650, Poly Bag Set 10 pcs



Dust Class M
Debu Kelas M | 集尘等级M

WET Basah 湿
DRY Kering 干



AUTOMATIC Self-cleaning Filtration System
Sistem Penapis Penyucian Automatik
自动清洗过滤系统

Continuous Rating Input Kuasa Sedutan 额定输入功率	1,050W
Max Peak Air Flow Aliran Udara 最大空气流量	2.0m ³ /min
Max Sealed Suction (water column) Sedutan Terkedap (Turus Air) 最大密封吸力(水柱)	22.0kPa (2,240 mmH ₂ O)
Tank Capacity Kapasiti 容量	Dust: 22L Water: 17L
Dimensions (L x W x H) Dimensi 体积	552x398x569mm (21-3/4"x15-5/8"x22-3/8")
Net Weight Berat Bersih 净重	16.3kg (35.9lbs)
Power Supply Cord Kabel Wayar 电源线	5.0m (16.4ft)

Cordless
Tangki Kordless

LED Flashlight
Lampu Bush LED
LED 闪光灯

Vacuum Cleaner
Pembersih Vakum

Drilling / Fastening
Gergasi / Pasang
电钻 / 紧固

Impact Drilling / Demolition
Gergasi / Hancurkan
电钻 / 拆除

Cutting
Pemotong
切割

Grinding / Sanding
Pergasi / Halus
打磨 / 打磨

Sawing
Gergasi
锯切

Planing / Routing
Pegasi / Tonggah
刨平 / 刨平

Others
Lain-lain
其他

Outdoor Power Equipment
Alatan Kuasa Luar
户外动力设备

Makita
1915

VACUUM CLEANER

Automatic self-cleaning filter (VC1310L, VC2510L, VC3210L)

Sistem Penapis Penyucian Automatik 自动清洗过滤系统

obtained by Triple filter structure composed of: Powder filter + Damper + Prefilter

Kuasa penyedutan yang berterusan sepanjang operasi kerana habuk dikeluarkan dari Prefilters setiap 10 saat semasa operasi

由三重过滤器结构得到：粉末过滤器+阻尼器+预过滤器

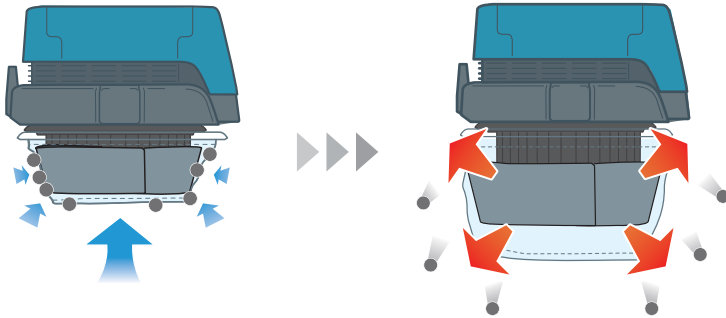

When the power is switched on, Prefilter collapses into itself to compress Damper, and fits closely over Damper and Powder filter.

Apabila kuasa dihidupkan, Prefilter runtuh ke dalamnya untuk memampatkan Damper, dan sesuai dengan penapis Damper dan Serbuk.

当接通电源时, Prefilter会自行折叠以压缩阻尼器, 并紧密贴合阻尼器和粉末过滤器。

When the power is switched off, Damper expands back to its original size and shakes off dust from Prefilter automatically with its expanding power.

Apabila kuasa dimatikan, Damper mengembang kembali ke saiz asalnya dan mengelakkan habuk dari Prefilter secara automatik dengan kuasa yang berkembang.

当电源关闭时, 阻尼器膨胀回到其原始尺寸, 并通过扩展的功率自动将Prefilter的灰尘抖落。



VC3210L

173 W

Vacuum Cleaner (Wet & Dry)
Pembersih Vakum (Basah Dan Kering)
吸尘器(干湿两用)



- For both wet and dry vacuum cleaning untuk menyedut kotoran kering atau lembap 适用于干和湿集尘清洁

Standard Equipment: Floor Nozzle, Corner Nozzle, Straight Pipe, Bent Pipe, Hose, Holder 10-33, Front Cuffs (22, 24, 38), Cloth Filter, Damper, Poly Bag Set (10pcs)



Continuous Rating Input Kuasa Sedutan 额定输入功率	1,050W
Max Peak Air Flow Aliran Udara 最大空气流量	2.0m ³ /min
Max Sealed Suction (water column) Sedutan Terkedap (Turus Air) 最大密封吸力(水柱)	22.0kPa (2,240 mmH ₂ O)
Tank Capacity Kapasiti 容量	Dust: 32L Water: 27L
Dimensions (L x W x H) Dimensi 体积	552x398x685mm (21-3/4"x15-5/8"x27")
Net Weight Berat Bersih 净重	14.5kg (32.0lbs)
Power Supply Cord Kabel Wayar 电源线	5.0m (16.4ft)

VC2510L

173 W

Vacuum Cleaner (Wet & Dry)
Pembersih Vakum (Basah Dan Kering)
吸尘器(干湿两用)



- For both wet and dry vacuum cleaning untuk menyedut samaada kotoran kering atau lembap 适用于干和湿集尘清洁

Standard Equipment: Hose, Holder 10-33, Front Cuffs (22, 24, 38), Poly Bag, Poly Bag Set 10pcs



Continuous Rating Input Kuasa Sedutan 额定输入功率	1,050W
Max Peak Air Flow Aliran Udara 最大空气流量	2.0m ³ /min
Max Sealed Suction (water column) Sedutan Terkedap (Turus Air) 最大密封吸力(水柱)	22.0kPa (2,240 mmH ₂ O)
Tank Capacity Kapasiti 容量	Dust: 25L Water: 14L
Dimensions (L x W x H) Dimensi 体积	432x416x451mm (17"x16-3/8"x17-3/4")
Net Weight Berat Bersih 净重	10.5kg (23.2lbs)
Power Supply Cord Kabel Wayar 电源线	5.0m (16.4ft)

VC1310LX1

173 W

Vacuum Cleaner (Wet & Dry)
Pembersih Vakum (Basah Dan Kering)
吸尘器(干湿两用)



- For both wet and dry vacuum cleaning untuk menyedut samaada kotoran kering atau lembap 适用于干和湿集尘清洁

Standard Equipment: Hose, Holder 10-33, Front Cuffs (22, 24, 38), Poly Bag Set, Cleaning Set



Come with

Cleaning Set



Continuous Rating Input Kuasa Sedutan 额定输入功率	1,050W
Max Peak Air Flow Aliran Udara 最大空气流量	2.0m ³ /min
Max Sealed Suction (water column) Sedutan Terkedap (Turus Air) 最大密封吸力(水柱)	22.0kPa (2,240 mmH ₂ O)
Tank Capacity Kapasiti 容量	Dust: 13L Water: 7L
Dimensions (L x W x H) Dimensi 体积	366x334x420mm (14-3/8"x13-1/8"x16-1/2")
Net Weight Berat Bersih 净重	9.6kg (21.2lbs)
Power Supply Cord Kabel Wayar 电源线	5.0m (16.4ft)

Cordless
Terdapat Model Berbeza

LED Flashlight
Lampu Cahaya LED
LED BAHU

Vacuum Cleaner
Pembersih Vakum

Drilling / Fastening
Dapat / Pasang
BOR, PASANG

Impact Drilling / Demolition
Ginjal / Perseki
BOR TUKAR, HANCURKAN

Cutting / Removing
GILANG

Grinding / Sanding
Pengisar / Pasir
GILANG / PASIR

Sanding / Grouting
GILANG / PASIR

Planing / Routing
Pengaliran / Pengaliran
BOR / PASIR

Others
Lain-lain

Outdoor Power Equipment
Alatan Kuasa Luar
BOR - PASIR

Makita
1915

Filter & Dust bag



for Dust
(Powder)

- Powder Filter Set
- Damper set
- Pre-filter set
- Dust paper filter or Poly bag set

Compatible with usual Poly bags or Paper filters, allowing for:



- Quick and easy dust disposal
- Lower-running cost compared with paper dust bag



	DVC862L DVC860L	DVC864L DVC863L DVC861L	VC3211H	VC3211M VC2211M VC2201M	VC3210L	VC2510L	VC1310L
	 (Wet & Dry)	 (Dry)	 (Wet & Dry)	 (Wet & Dry)	 (Wet & Dry)	 (Wet & Dry)	 (Wet & Dry)
Powder Filter Set Dry only	*197166-6 	*197166-6 	196251-2 	196252-0 	195441-4 	195441-4 	195438-3
*HEPA filter							
Pre-filter set	195553-3 	195553-3 	196253-8 	196253-8 	195612-3 	195554-1 	195553-3
Cloth filter	140248-3 						
Damper set	195552-5 	195552-5 	196254-6 	196254-6 	195552-5 	195552-5 	195552-5
Filter for water set Water only	195555-9 				195611-5 	195556-7 	195555-9
Paper filter set (5pcs) for dry dust except powder	194556-4 (A-48430) 	194556-4 (A-48430) 					194556-4 (A-48430)
Dust paper filter 7L (5pcs) for dry powder	194719-2 (A-49541) 	194719-2 (A-49541) 					194719-2 (A-49541)
Filter bag set 15L (5pcs) for dry dust	195557-5 	195557-5 				195557-5 	195557-5
Filter bag set 25L (5pcs) for dry dust			195558-3 	195558-3 	195558-3 		
Poly bag set (10pcs)	195432-5 	195432-5 	195440-6 	195440-6 	195440-6 	195440-6 	195432-5

Cordless
Temp. Kontrol 0.0°C

LED Flashlight
Lampu Suhu LED
LEDCOR02

Vacuum Cleaner
Penyedot Vakum
0.25kW

Drilling / Fastening
Gergaji / Pasak
0.8kW

Impact Drilling / Demolition
Gergaji / Perusak
0.7kW

Cutting
Pemotong
0.6kW

Grinding / Sanding
Paspasar / Halus
0.6kW

Sawing
Gergaji
0.6kW

Planing / Routing
Perataan / Tenggang
0.6kW

Others
Lain-lain
0.6kW

Outdoor Power Equipment
Alat-alat Kerja Luar
0.6kW

Makita
1915

Vacuum Cleaner System charts

Hose connection
28mm

Hose connection
38mm

Hose connection
32mm

For Cleaning

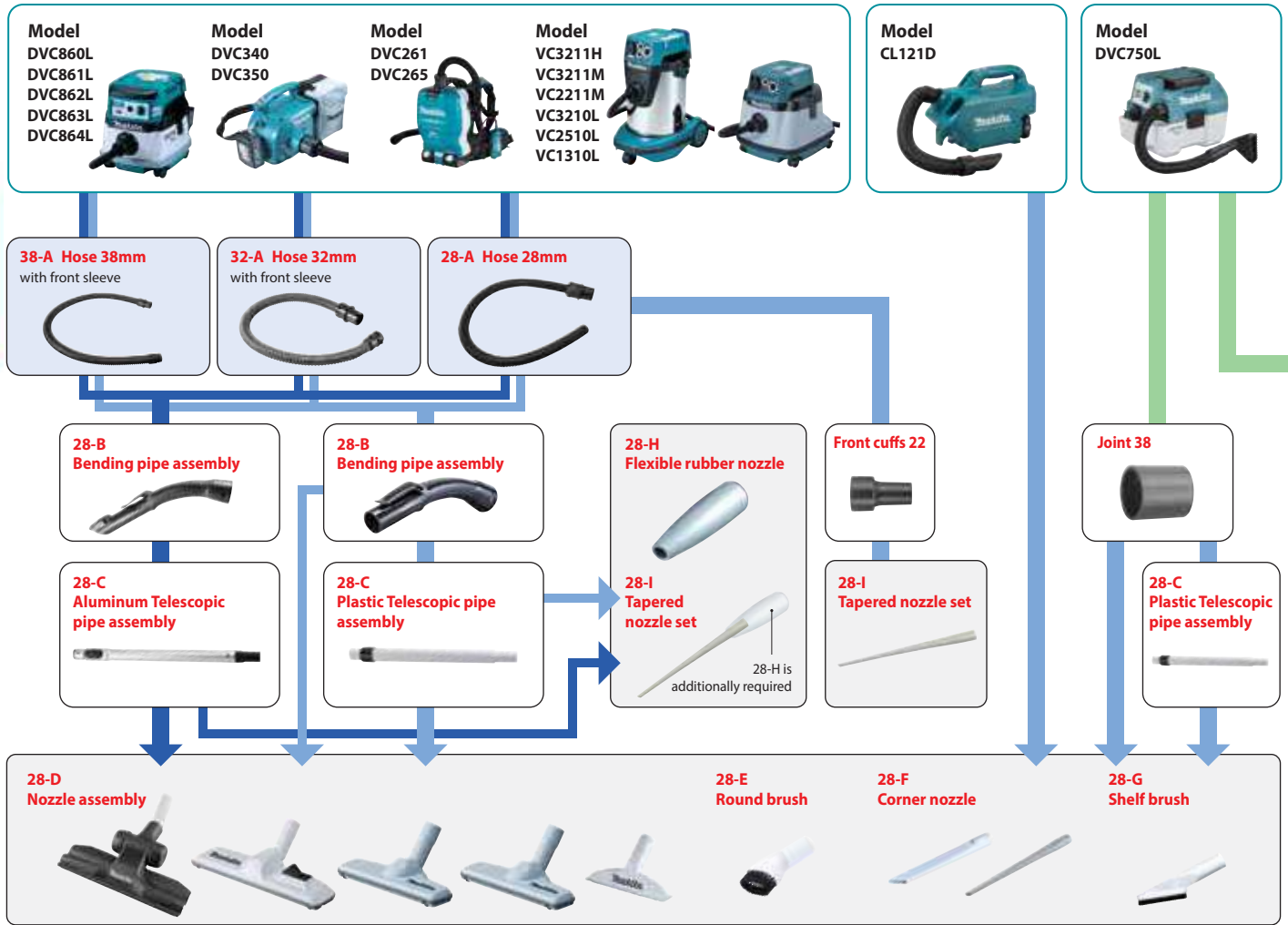

For Dust Collecting

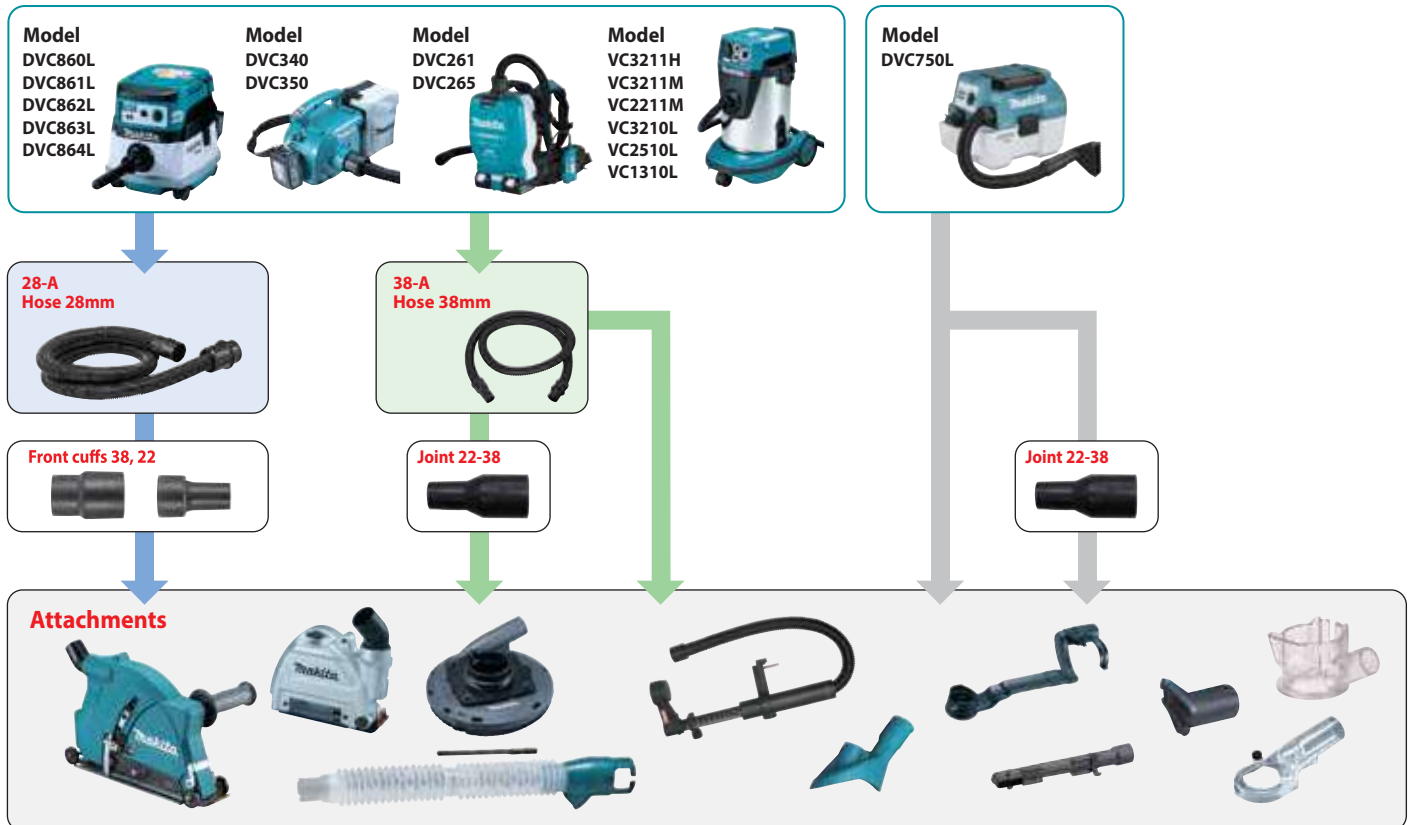

Cordless
Tethered Cordless

LED Flashlight
Lamp / Light LED
LED 3W / 1W

Vacuum Cleaner
Anti-static Vacuum
集塵機

Drilling / Fastening
Drill / 打釘機
釘機 / 釘機

Impact Drilling / Demolition
Drill / 打釘機
釘機 / 釘機

Cutting
Cutting
切機

Grinding / Sanding
Grinder / 砂機
砂機 / 砂機

Sawing
Sawing
鋸機

Piercing / Routing
Piercing / 鑽機
鑽機 / 鑽機

Others
Others
其他

Outdoor Power Equipment
Outdoor Power Equipment
戶外動力設備

Makita
Makita

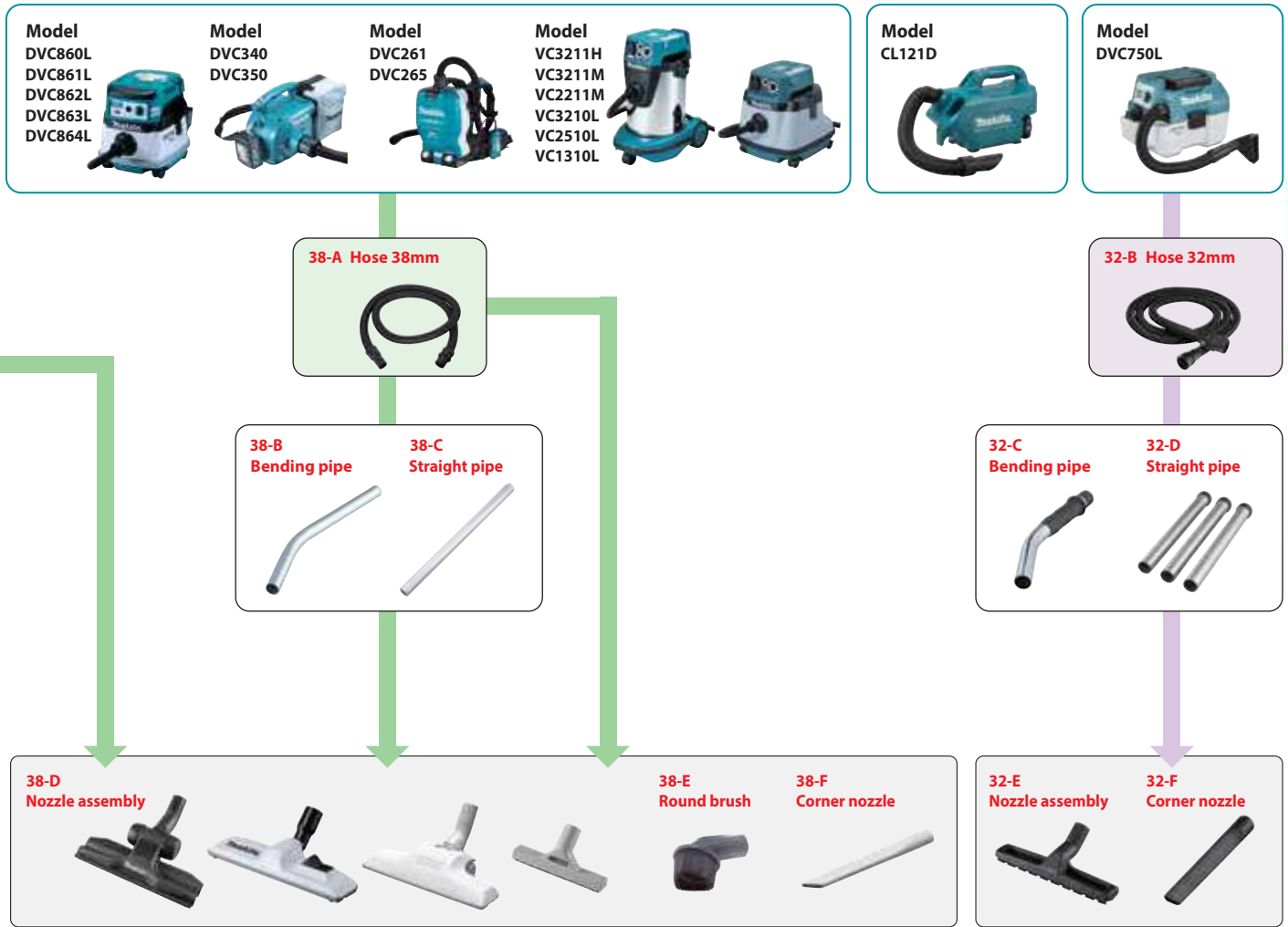

Front cuffs, Joint & Hose Connection

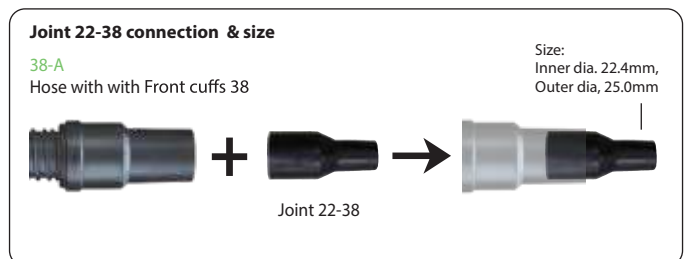
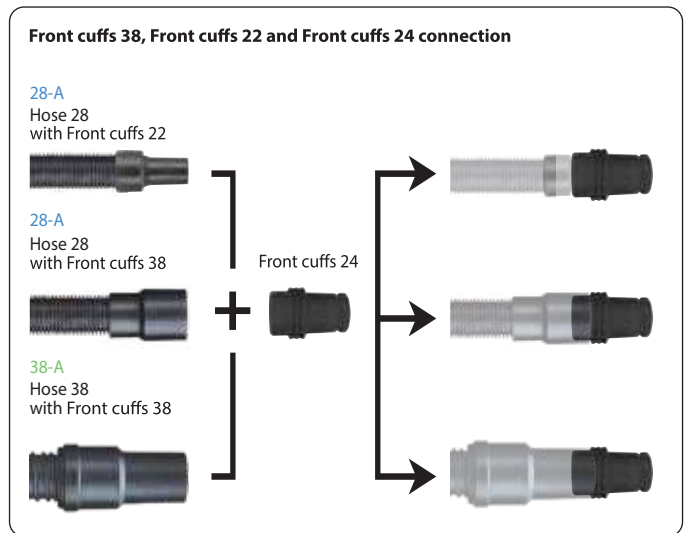
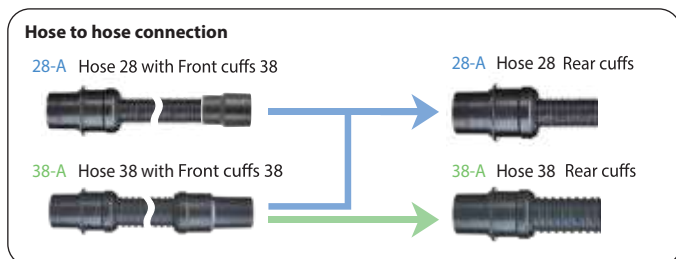
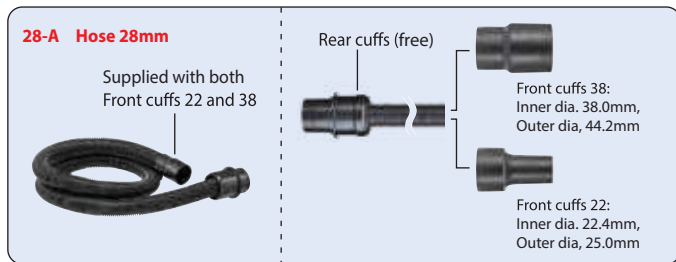

Cordless
Tempat Kordless

LED Flashlight
Lampu Senter LED
LEDFLASHLIGHT

Vacuum Cleaner
Penisbiak Vakuum

Drilling / Fastening
Gergaji / Pasak

Impact Drilling / Demolition
Gergaji / Perusak

Cutting
Pemotong

Grinding / Sanding
Pergasi / Halus

Sawing
Gergaji















Planing / Routing
Perataan / Tenggang



Others
Lain-lain



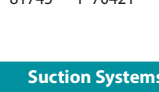

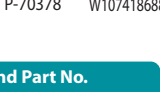
Outdoor Power Equipment
Alat-alat Kuda Lunta

Makita
— THE —

System charts

<p>A</p>  <p>W/ Ø28mm Hose</p> <p>Model VC3211H VC3211M VC2211M VC3210L</p> <p>W/ Front cuffs</p>  <p>38 24 22</p>	<p>B</p>  <p>W/ Ø28mm Hose</p> <p>Model VC2510L VC1310L DVC861L DVC863L DVC864L</p> <p>W/ Front cuffs</p>  <p>38 24 22</p>	<p>C</p>  <p>W/ Ø28mm Hose</p> <p>Model DVC350</p> <p>W/ Front cuffs</p>  <p>38 24 22</p>	<p>D</p>  <p>W/ Ø38mm Hose</p> <p>Model DVC860L DVC861L DVC862L DVC863L DVC750L</p> <p>W/ Joint 22-38</p> 	<p>E</p>  <p>W/ Ø28mm Hose</p> <p>Model DVC261 DVC265</p> <p>W/ Front cuffs</p>  <p>38 24 22</p>	<p>F</p>  <p>W/ Ø32mm Hose</p> <p>Model VC2012L VC2512L VC3011L</p> <p>W/ Tool adapter 24</p>  <p>P-81745</p> <p>Adapter 38 (option)</p>  <p>P-70421</p>	<p>G</p>  <p>W/ Ø32mm Hose</p> <p>Model VC3012L VC4010L VC3012M VC4010M</p> <p>W/ Tool adapter 24</p>  <p>P-70378</p> <p>38</p>  <p>W107418688</p>
---	---	--	---	---	---	---

For Model	Suction Systems and Part No.
<p>Rotary Hammer, Demolition Hammer SDS-MAX, 17mm (11/16") Hex: Bull points with over 280mm length Cold chisels with over 280mm length</p> <p>SDS-MAX only: Scaling chisel (for tile), Bushing tool Scaling chisels length</p> <p>19mm (3/4") Hex only Scaling chisels</p> <p>17mm(11/16")Hex: HM0830,HR3530, HR4030C</p> <p>SDS-MAX: HR4001C/02/10C/11C, HR4501C/10C/11C, HR3540C/41FC HM0870C/71C, HM1101C/11C, HM1203C/13C, HM1214C HR4501C/10C/11C, HR4013C HR4003C, HR3540C/41FC DHR400, HR5202C, HR5212C, HM1205</p> <p>19mm(3/4")Hex: HR4041C</p>	<p>Dust extractor attachment set (Hammering mode only) 199144-2 (w/hose for) 199143-4 (w/o hose for)</p>  <p>ø28mm hose can be directly connected.</p> <p>A Directly</p> <p>B Directly</p> <p>C Directly</p> <p>D ø28mm hose</p> <p>E Directly</p> <p>F Tool adapter 24</p> <p>G Tool adapter 24</p>
<p>Electric Breaker HM1304/B, HM1306, HM1317C/CB, HM1307C/CB, HM1400, HM1500/B, HM1810, HM1801, HM1812, HM1802</p>  <p>197168-2 (w/o hose for) 197148-8 (w/ hose for)</p> <p>ø28mm hose can be directly connected.</p>	<p>Vacuum attachment set</p>  <p>A Directly</p> <p>B Directly</p> <p>C Directly</p> <p>D ø28mm hose</p> <p>E Directly</p> <p>F Tool adapter 24</p> <p>G Tool adapter 24</p>

For Model	Suction Systems and Part No.
<p>Rotary Hammer, Combination Hammer see page 150</p> <p>DHR242, HR2650, HR2651, HR2652, HR2653, HR2661, HR2663, DHR280, DHR282, HR2300, HR2600, HR2601, HR2601F, HR2630, HR2631F, HR2641 DHR243, HR2651T, HR2653T, HR2300T, HR2320T, HR2630T, HR2631FT,</p> <p>DHR164, DHR165, DHR171, DHR182, HR140D, HR166D, HR1840, HR1841F, HR2800, HR2810, HR2811F, DHR202, DHR241, DHR263, HR2230, HR2460, HR2460F, HR2470, HR2475</p> <p>Rotary Hammer, Combination Hammer DHR164, DHR165 DHR202, BHR262/T DHR263, DHR264</p> <p>HR2470 series HR2800 series</p> <p>Rotary Hammer HR4002, HR4011C, HR4010C, HR4001C, HR4511C, HR4510C, HR4501C</p> <p>DHR400, HR4013C, HR4003C HR5212C, HR5202C</p>	<p>Dust cup set 195173-3</p>  <p>Dust extractor attachment 193472-7</p>  <p>Vacuum attachment 195866-2</p>  <p>(Max. Bit Diameter 40mm)</p>  <p>199142-6 196858-4</p> <p>A Front cuffs 22</p> <p>B Front cuffs 22</p> <p>C Front cuffs 22</p> <p>D Joint 22-38 195548-6</p> <p>E Front cuffs 22</p> <p>F Tool adapter + Joint 25-50 192349-3</p> <p>G Tool adapter 38 + Joint 22-38 195548-6</p>

Cordless
Tenshi Kōrō (無線)

LED Flashlight
Lampu Halah LED
LED 照度計

Vacuum Cleaner
Vakuu Puhastaja
真空掃除機

Drilling / Fastening
Oreus / Pöytäkiel
ドリル / 締め

Impact Drilling / Demolition
Oreus / Pöytäkiel
ドリル / 解体

Cutting
Hirvenleikkaus
切断

Grinding / Sanding
Hirvenleikkaus / Pöytäkiel
研削 / 締め

Sawing
Hirvenleikkaus
切断











Piercing / Routing
Pöytäkiel / Pöytäkiel
締め / 締め

Others
Lainat
その他















Outdoor Power Equipment
Aluevoima- ja työkalut
屋外動力機器

Makita
マキタ

System charts

For Model	Suction Systems and Part No.
Angle Cutter 4112H 4112HS 4114 4114S 	Elbow joint 32 192613-2 
Dustless Cutter 4105KB 	Elbow joint 32 192613-2 
Dustless Cutter 4100KB 	
Cutter With Dust Collection 4157KB 	
Wall Chaser SG1251, SG1250 	
Concrete Planer PC5000C, PC5001C PC5010C 	
Angle Grinder For 115, 125mm Model Single notch _____ w/o mark of origin 195237-3 Triple notches _____ w/o mark of origin for IEC 195239-9 w/ mark of origin for IEC 195238-1 North America package 195236-5 North America package for UL 196575-6 For 180,230mm Model w/ mark of origin for IEC 195384-0 w/o mark of origin for IEC 195385-8 North America package for UL 197584-8 Twin notches _____ w/ mark of origin 195387-4 w/o mark of origin 195388-2 North America package 195386-6 	Dust collecting wheel guard For cup type diamond wheel 



For Model	Suction Systems and Part No.
Angle Grinder For 125mm Model _____ 196845-3 _____ 196846-1 	Dust collecting wheel guard 
Angle Grinder For 230mm Model _____ 198379-2 _____ 198380-7 	
Angle Grinder For 115, 125mm Model _____ 192968-5 _____ 193794-5 (Economy type) For 180mm Model _____ 194303-3 For 230mm Model _____ 194044-1 	Dust collecting wheel guard 
Belt Sander 9924DB 	Joint 32 192518-6 
Belt Sander 9404, 9902, 9903, 9910, 9911, 9920, 	
Belt Sander 9403, 9921 	Joint 32 192349-3 
Wheel Sander 9741 	Joint 410899-9 



Cordless
Tempo Model 08.06.16

LED Flashlight
Lampo Shush LED
LFC08002

Vacuum Cleaner
Penbanshi Yokuni
3.3.15.15

Drilling / Fastening
Goussu / Poussei
08.15.15.15

Impact Drilling / Demolition
Goussu / Poussei
08.15.15.15

Cutting
Penshi
08.15.15.15

Grinding / Sanding
Penshi / Poussei
08.15.15.15

Sanding
Goussu
08.15.15.15

Planing / Routing
Poussei / Tengou
08.15.15.15

Others
Lan-kan
08.15.15.15

Outdoor Power Equipment
Araji Ketai Unit
08.15.15.15

Makita
1919

System charts

Cordless
Tangle-Proof Cable

LED Flashlight
Lamp Bulb LED
LED BRIGHT

Vacuum Cleaner
Anti-Static Vacuum

Drilling / Fastening
Drill / Impact
M10, M12

Impact Drilling / Demolition
Drill / Hammer
M10, M12, M14, M16

Cutting
Removal

Grinding / Sanding
Grinder / Sander
M10, M12



















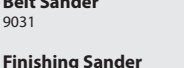

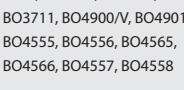

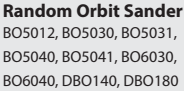
Sawing
Circular
M10, M12

Planing / Routing
Planer / Router
M10, M12







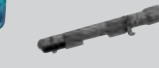













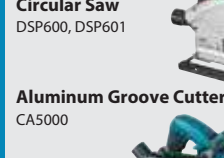

Others
Lawnmower
M10

Outdoor Power Equipment
Aluminum Kettle Line
M10, M12

Makita
1911



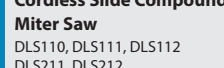



For Model	Suction Systems and Part No.
Disc Grinder N9500N, 9500NB 	Dust collecting wheel guard 192212-0  Rubber sleeve 192202-3 
Angle Grinder For 100mm Model  For 115,125mm Model 	Dust collecting wheel guard Dust collecting 100C set — 198413-8 Dust collecting 100CD set — 198414-6  198415-4 
Belt Sander 9032 	Dust nozzle assembly 122652-8 
Belt Sander 9031 	
Finishing Sander 9046, BO3700, BO3710, BO3711, BO4900/V, BO4901, BO4555, BO4556, BO4565, BO4566, BO4557, BO4558 	
Random Orbit Sander BO5012, BO5030, BO5031, BO5040, BO5041, BO6030, BO6040, DBO140, DBO180 	
Multi Tool DTM50, DTM40 — 195965-0 TM3000C — 196022-7 TM3010C — 196550-2  DTM51, DTM41 — 196765-1 	Dust attachment set 
Circular Saw DHS630 — 194314-8 DSS611, DSS610 — 419283-5 DSS501, DSS500 — 194415-2 HS300D, HS301D — 195334-5 	Joint (Dust nozzle) 
Jig Saw JV100D, JV143D, JV183D, 4326, 4327, 4328, 4329, JV0600 	
Jig Saw DJV140, DJV180, 4350T/CT/FCT, 4351T/CT/FCT 	Dust Nozzle 417853-4 











For Model	Suction Systems and Part No.
	front cuffs24 195546-0 
Circular Saw HS6100, HS6101, HS7100, HS7101 — 453289-3 DHS710, HS6600, HS6601, HS7010, HS7600, HS7601, HS7610, HS7611 — 196520-1 HS6600, HS7000, HS7600, DHS711 — 196843-7 (with short lever) 5007N, 5007NF — 199712-1 (with short lever) HS0600 — 198263-1 DHS680 — 196961-1 196952-2 (with short lever) HS7000, HS7600 — 196520-1 197221-4 (with short lever)	Joint (Dust nozzle) 453289-3 
	front cuffs 22  front cuffs 22  front cuffs 22  front cuffs 22 
Plunge Cut Circular Saw SP6000 	Front cuffs 24 195546-0 
Cordless Plunge Cut Circular Saw DSP600, DSP601 	
Aluminum Groove Cutter CA5000 	
Cordless Jig Saw DJV141, DJV142 — 126331-0 DJV181, DJV182 — 457801-1 DJV102D, JV103D — 457801-1 	Dust nozzle assembly 126331-0  457801-1  Front cuffs 24 195546-0 
Slide Compound Saw LS1019/L, LS1219/L 	Front cuffs 24 195546-0 
Cordless Slide Compound Miter Saw DLS110, DLS111, DLS112, DLS211, DLS212 	

* not needed
Front cuffs 24

System charts

For Model	Suction Systems and Part No.
Cordless Slide Compound Miter Saw DLS713 DLS714	 <p>A Front cuffs 38</p>
Slide Compound Saw LS0714/F/FL/L LS0815F/FL LS1016L LS1017L LS1018/L LS1216/L	 <p>B Front cuffs 38</p>
Miter Saw LS1030N, LS1440	 <p>C Front cuffs 38</p>
Compound Miter Saw LS1040/F, LS1045, LS1221	 <p>D Front cuffs 38</p>
Cordless Compound Miter Saw DLS600	 <p>E Front cuffs 38</p>
Flip Over Saw LF1000	 <p>F Adapter 38</p>
Table Top Miter Saw LH1040/F LH1201FL	 <p>G Tool adapter 38</p>

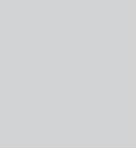
For Model	Suction Systems and Part No.
Table Saw 2704N, 2705	Joint 419093-0
 <p>A Front cuffs 38</p>	 <p>B Front cuffs 38</p>
Table Saw 2703	Joint 55 192799-2
 <p>C Front cuffs 38</p>	 <p>D Front cuffs 38</p>
Table Saw MLT100N	Dust point JM27000090
 <p>E Front cuffs 38</p>	 <p>F Adapter 38</p>
Table Saw 2712	Joint 419093-0
 <p>G Tool adapter 38</p>	 <p>H Adapter 38</p>
Band Saw LB1200F	Joint 419093-0
 <p>I Adapter 38</p>	 <p>J Tool adapter 38</p>



Cordless
Tempat Kiri D.R.C.

LED Flashlight
Lampu Senter LED
LEDC030C2

Vacuum Cleaner
Penisipah Vakuum
VJ3330

Drilling / Fastening
Gergaji / Pengencap
BES1 / BES2

Impact Drilling / Demolition
Gergaji / Perusak
BES10M3 / BES10L3

Cutting
Pemotong
C24

Grinding / Sanding
Pergasi / Halus
BES1 / BES2

Sawing
Gergaji
BES1

Planing / Routing
Perhalus / Tenggam
BES1 / BES2

Others
Lain-lain
BES

Outdoor Power Equipment
Alat-alat Kerja Luar
BES1-246

Makita
THE POWER OF TOOLS

System charts

Cordless
Tansu Houd 無線式

LED Flashlight
Lampu Senter LED
LED照灯

Vacuum Cleaner
Penyedot Vakum
吸尘器

Drilling / Fastening
Dremel / Pengikat
电钻 / 电批

Impact Drilling / Demolition
Giriul / Perusak
电钻 / 电锤

Cutting
Pemotong
切割机

Grinding / Sanding
Pengkilan / Pasir
打磨 / 砂磨



Sawing
Gergaji
电锯

Piercing / Routing
Pencetakan / Trogram
电钻 / 电批

Others
Lain-lain
其他

Outdoor Power Equipment
Alat-alat Listrik
电钻 / 电批

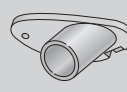
Makita
マキタ

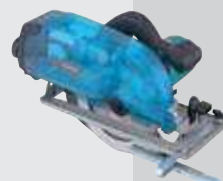
For Model	Suction Systems and Part No.
Circular Saw 5603R, 5704R, 5705R 5143R 5008MG 5103R, 5903R 5104S, 5104 N5900B, 5902B	Joint (Dust nozzle) 192420-3 192490-2 450079-5 194489-3 (with short lever) 192419-8 450316-7 193823-9 193068-4 (with short lever)
	
Circular Saw 5604R, 5037NB	
Dustless Circular Saw 5017RKB 5057KB	



A
Front cuffs 38



B
Front cuffs 38

C*
Front cuffs 38









D
Front cuffs 38



E
Front cuffs 38



F
Adapter 38



G
Tool adapter 38

*C: DVC350, DVC340
Cannot be used with
Planner models

For Model	Suction Systems and Part No.
Power Planer 1050D, 1051D KP0810/C	Front cuffs 38
	
Power Planer DKP180, DKP140 KP0800	Nozzle 451329-1
	
1805N	JPA122277
Power Planer 1911B	Nozzle for vacuum cleaner 192082-7
	
Power Planer N1900B, N1923B, KP0800, 1804N 1805N, 1806B, KP312/S	Front cuffs 38
	



A
Front cuffs 38



B
Front cuffs 38

C*
Front cuffs 38

D
Front cuffs 38

E
Front cuffs 38

F
Adapter 38

G
Tool adapter 38

*C: DVC350, DVC340
Cannot be used with
Planner models



Nozzle assembly



Joint

*Elbow







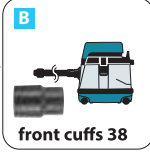

Model No.	Part No.	Model No.	Part No.
N1900B, N1923B	181572-5	N1900B, N1923B	JPA122275 (122275-2)
KP0800, DKP180, DKP140	451329-1	DKP180, DKP140, KP0810/ C, KP0800	*416368-8
1804N	JPA122278 (122278-6)	1804N, 1805N, 1806B, KP312/S	181575-9
1805N	JPA122277 (122277-6)		
1806B	122397-8		
KP312/S	193733-5		

System charts

For Model	Suction Systems and Part No.
Plate Joiner PJ7000, 3901, DPJ180, DPJ140	 <p>A front cuffs 22</p>
Cut-out Tool 3706	 <p>B front cuffs 22</p>
Dust collection cover 193449-2	 <p>C* front cuffs 22</p>
Cordless Cut-out Tool DCO180	 <p>D Joint 22-38 195548-6</p>
Cordless Drywall saw DSD180, SD100D	 <p>E front cuffs 22</p>
Router RP0910, RP1110C	 <p>F Tool adapter 24 + Joint 25-50 192349-3</p>
	 <p>G Tool adapter 38 + Joint 22-38 195548-6</p>

*C: DVC350 Cannot be used with Router models

For Model	Suction Systems and Part No.
Router RP1801/ F RP1800/ F RP2301FC RP2300FC	Dust nozzle 194934-8
 <p>A front cuffs 38</p>	 <p>B front cuffs 38</p>
Router RD1100, RD1101, RF1100, RF1101, RP1100, RP1101	Dust nozzle 193379-7
 <p>C front cuffs 38</p>	 <p>D front cuffs 38</p>
Router RP0900, ***RT0700C, DRT50	Dust nozzle 194733-8
Cordless Router DRT50	 <p>E front cuffs 38</p>
*** Use with Plunge base assembly	 <p>F Adapter 38</p>
Trimmer RT0700C	Dust nozzle 195559-1
Cordless Trimmer DRT50	 <p>G Tool adapter 38</p>

Makita recommend to use 38mm hose when you use Router



Cordless
Tempat Kerja Bekerja

LED Flashlight
Lampu Senter LED
LEDFLASHLIGHT

Vacuum Cleaner
Penisiprasi Vakuum
真空掃除機

Drilling / Fastening
Gergaji / Pengencat
ドリル / 締め

Impact Drilling / Demolition
Gergaji / Pemecah
ドリル / 破砕機

Cutting
Pemotong
切断機

Grinding / Sanding
Pengeris / Halus
研削 / 研削

Sawing
Gergaji
鋸

Planing / Routing
Perataan / Tenggang
めし / 彫り

Others
Lain-lain
その他

Outdoor Power Equipment
Alat-alat Kerja Luar
屋外動力機器

Makita
1915

Cordless
Tethered Hand Tools

LED Flashlight
Lampu Senter LED
LED Senter

Vacuum Cleaner
Penyedot Vakum

Drilling / Fastening
Dremel / Pengikat

Impact Drilling / Demolition
Giriul / Perusak

Cutting
Pemotong

Grinding / Sanding
Pengkil / Pasir

Sawing
Gergaji

Piercing / Routing
Pergaram / Pengalir

Others
Lain-lain

Outdoor Power Equipment
Alat-alat Listrik Luar Ruangan

Makita
19152

Front cuffs & Joint

Front cuffs 22



Front cuffs 24



Front cuffs 38



Joint 22-38



Joint 38



Joint H

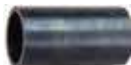

Rubber sleeve 18-21



Type	Part No.
Front cuffs 22	195547-8
Front cuffs 24	195546-0
Front cuffs 38	195545-2
Joint 22-38	195548-6
Joint 38	418500-0
Joint H	424009-2
Rubber sleeve 18-21	192202-3

Hose connection 28mm

28-A

Hose

Note:
Can be connected with power tools, Front cuffs and Joint are required for some power tools.

*DVC260, DVC261, DVC265 only

*for cleaning (Use with Bending pipe assembly)

Size	Length (m)	with Front cuffs	Part No.
28mm	1.0	-	*143787-2
28mm	1.5	-	*144408-9
28mm	1.5	38	*152992-0
28mm	1.5	22, 38	A-34235
28mm	2.5	22, 24, 38	195437-5
28mm	3.5	22, 24, 38	195433-3
28mm	5	22, 24, 38	195436-7
28mm	5	22, 38	A-34229

Hose connection 32mm

32-A

Hose 32mm

for cleaning
Use with 28-B Bending pipe assembly

Size	Length (m)	with Front cuffs	Part No.
32mm	1.0	Sleeve	199453-9
32mm	1.7	Sleeve	199493-7

28-B

Bending pipe

*with Hose 28 sleeve



Description	Part No.
For Aluminum (Part No. 140G19-0) Telescopic pipe assembly with lock	140G26-3
	*127093-3
For plastic straight pipe 28 and Telescopic pipe assembly 28	458184-2
	*126756-8

28-C

Straight pipe



Description	Part No.	EU
		Part No.
Aluminum Telescopic pipe assembly Pipe length is variably adjustable from 590 to 942mm.	140G19-0	-
Telescopic pipe assembly 28 Pipe length is variably adjustable from 500 to 850mm.	198559-0	198560-5

28-D

Nozzle assembly

Flat type

F/C switching t-nozzle 28
Flooring & carpet

Floor/carpet t-nozzle
For rug / carpet cleaning

For rug / carpet cleaning

Floor t-nozzle 28

Seat nozzle 28
For car seat



Description	Color	Part No.	EU
			Part No.
Flat type	Black	199454-7	-
F/C switching t-nozzle 28 Flooring & carpet	White	198183-9	198532-0
Floor/carpet t-nozzle For rug / carpet cleaning	White	198525-7	198528-1
	Black	198526-5	198529-9
For rug / carpet cleaning	Ivory	122291-4	-
Floor t-nozzle 28	White	123486-2	-
Seat nozzle 28 For car seat	White	199037-3	199038-1
	Black	198921-9	199039-9

28-E Round brush



Color	Part No.	EU
		Part No.
White	198877-6	198878-4
Black	198551-6	198555-8

28-F Corner nozzle

Type	Color	Part No.	EU
			Part No.
300-28mm	White	198918-8	198919-6
	Black	198991-8	198992-6
Crevice nozzle 415 set	White	199439-3	-

28-G Shelf brush

(For gentle cleaning by soft-tipped brush)



Color	Part No.	EU
		Part No.
White	198872-6	198873-4
Black	198536-2	198540-1

28-H Flexible rubber nozzle



Color	Part No.	EU
		Part No.
Gray	197900-4	197901-2

28-I Tapered nozzle set

Use with Front cutts 22 or Flexible rubber nozzle



Color	Part No.	EU
		Part No.
gray	192236-6	198558-2

Hose stand

For model
VC2510L



Part No.
197323-6

Holder set 10-33



Part No.
195544-4

Holder cuff set



Components	Part No.
Holder 10-33, Front cuff 24, Front cuff 22	195637-7



Cordless
Tempat Motor 2000W

LED Flashlight
Lampu Senter LED
LECOB3002

Vacuum Cleaner
Pembersih Vakuum
VC2510L

Drilling / Fastening
Detail / Pengisian
BET / 3000

Impact Drilling / Demolition
Detail / Perusakan
BET / 3000

Cutting
Pemotongan
Detail

Grinding / Sanding
Pengerjaan / Halus
Detail / 3000

Sawing
Gergaji
Detail

Planing / Routing
Perataan / Tergesam
Detail / 3000

Others
Lain-lain
Detail

Outdoor Power Equipment
Alat-alat Kerja Luar
Detail / 3000

Trakita
TIME

Cordless
Tangle-Proof Cable

LED Flashlight
Lamp Built LED
LED BATT

Vacuum Cleaner
Anti-static Vacuum
集塵機

Drilling / Fastening
Drill / Fastener
ドリル / 部品

Impact Drilling / Demolition
Drill / Demolition
ドリル / 破砕加工

Cutting
Hemmer
切断

Grinding / Sanding
Grinder / Sander
研削 / 研磨

Sawing
Cutter
切断

Piercing / Routing
Piercer / Router
穿孔 / 彫削

Others
Lawn-leaf
その他

Outdoor Power Equipment
Aluminum Kettle Line
園具・工具



Hose connection 38mm

38-A

Hose 38mm

for cleaning
*Use with 28-B Bending pipe assembly



Size	Length (m)	with Front cuffs	Part No.
38mm	1.5	-	*199388-4
38mm	1.5	38	198757-6
38mm	2.5	38	195434-1
38mm	5	38	195435-9

Cleaning set

Includes one each of:
-Hose complete 38-2.5
-Straight pipe
-Bending pipe
-Nozzle assembly
-Corner nozzle



Part No.
195439-1

38-B

Bending pipe



Description	Part No.
Aluminum	192562-3

38-C

Straight pipe



Description	Part No.
Aluminum	192563-1

38-D

Nozzle assembly

Flat type



Flooring & carpet

Universal Type

Compact Type A

Compact Type B
(wet model only)

Wide Type
(wet model only)

Description	Dry/ Wet	Part No.	EU
			Part No.
Flat type	Dry	199455-5	
Flooring & carpet	Dry	198184-7	198533-8
Universal Type	Dry/ Wet	195551-7	-
Compact Type A	Dry	195549-4	122334-2
Compact Type B	Wet	195550-9	122335-0
Wide Type	Wet	A-47846	-

38-E

Round brush



Type	Color	Part No.	EU
			Part No.
38mm	Black	191657-9	-

38-F

Corner nozzle



Type	Color	Part No.
38mm	Yellow gray	410306-2

DRILLING FASTENING

Penggerudian | Mengetat 钻孔 | 紧固



DF0300 10mm (3/8")

411

Driver Drill

Gerudi Pemutar Skru
螺丝起子电钻



- **Compact Design with a Short Overall Length**
Reka bentuk padat dan pendek
紧凑小巧的设计

Standard Equipment: (+)(-) Bit



Continuous Rating Input Input Kuasa Berterusan 额定输入功率	320W
Capacity Kapasiti 能力	Steel: 10mm (3/8") Wood: 28mm (1-1/8")
Chuck Capacity Kapasiti Chuck 夹头能力	1.0 - 10mm (1/32 - 3/8")
No Load Speed (RPM) Kelajuan Tanpa Beban 回转数	High: 0 - 1,500 Low: 0 - 450
Max Fastening Torque Tenaga Pemutaran Pengancing Maksimum 最快扭转	Hard 56.0N-m (500in.lbs.) Soft: 21.0N-m (190in.lbs.)
Max Lock Torque Pemutaran Tenaga Maksimum 最大锁定扭力	42.0N-m (370in.lbs.)
Dimensions (L x W x H) Dimensi 体积	220x67x206mm (8-5/8"x2-5/8"x8-1/8")
Net Weight Berat Bersih 净重	1.2kg (2.7lbs.)
Power Supply Cord Kabel Wayar 电源线	2.5m (8.2ft)

DP2010 6.5mm (1/4")

419

High Speed Drill

Gerudi Kelajuan Tinggi
高速钻



- **Compact and high power**
Kuasa tinggi dan padat
紧凑和高功率

Standard Equipment: Chuck Key



Continuous Rating Input Input Kuasa Berterusan 额定输入功率	370W
Capacity Kapasiti 能力	Steel: 6.5mm (1/4") Wood: 15mm (9/16")
No Load Speed (RPM) Kelajuan Tanpa Beban 回转数	0-4,200
Dimensions (L x W x H) Dimensi 体积	209x64x175mm (8-1/4"x2-1/2"x6-7/8")
Net Weight Berat Bersih 净重	1.0kg (2.2lbs.)
Power Supply Cord Kabel Wayar 电源线	2.0m (6.6ft)

6305 13mm (1/2")

303

Drill

Gerudi
电钻



- **Heavy duty motor**
Motor tugas berat unggul
卓越马达

Standard Equipment: Chuck Key, Depth Gauge, Side Grip



Continuous Rating Input Input Kuasa Berterusan 额定输入功率	850W
Capacity Kapasiti 能力	Steel: 13mm (1/2") Wood: 30mm (1-3/16")
No Load Speed (RPM) Kelajuan Tanpa Beban 回转数	1,450
Dimensions (L x W x H) Dimensi 体积	346x84x152mm (13-5/8"x3-5/16"x6")
Net Weight Berat Bersih 净重	2.8kg (6.2lbs.)
Power Supply Cord Kabel Wayar 电源线	2.5m (8.2ft)

6413 10mm (3/8")

64

Drill

Gerudi
电钻



- **General Purpose Drill Featuring Compact And Lightweight Design**
Reka Bentuk Kompak Dan Ringan untuk penggerudian tujuan umum
紧凑轻巧机身适合一般用途



Continuous Rating Input Input Kuasa Berterusan 额定输入功率	450W
Capacity Kapasiti 能力	Steel: 10mm (3/8") Wood: 25mm (1")
No Load Speed (RPM) Kelajuan Tanpa Beban 回转数	0-3,400
Dimensions (L x W x H) Dimensi 体积	234x64x183mm (9-1/4"x2-1/2"x7-1/4")
Net Weight Berat Bersih 净重	1.3kg (2.9lbs)
Power Supply Cord Kabel Wayar 电源线	2.0m (6.6ft)

Cordless
Tanpa Hood B-B-E-E

LED Flashlight
Lampu Cahaya LED
L-C-O-R-D-I-L-I-T

Vacuum Cleaner
Penyedut Vakuum
V-A-C-U-U-M

Drilling / Fastening
Gerudi / Pengancing
D-R-I-L-L-I-N-G / F-A-S-T-E-N-I-N-G

Impact Drilling / Demolition
Gerudi / Pembinaan
I-M-P-A-C-T / D-E-M-O-L-I-T-I-O-N

Cutting
Pemotongan
C-U-T-T-I-N-G

Grinding / Sanding
Pergesakan / Mengkilap
G-R-I-N-D-I-N-G / S-A-N-D-I-N-G

Sawing
Gajuh
S-A-W-I-N-G

Planing / Routing
Pergesakan / Tenggang
P-L-A-N-I-N-G / R-O-U-T-I-N-G

Others
Lain-lain
O-T-H-E-R-S

Outdoor Power Equipment
Alatan Kuasa Luar
O-U-T-D-O-O-R / P-O-W-E-R / E-Q-U-I-P-M-E-N-T

Makita
M-I-T-I

DRILLING | FASTENING

Cordless
Tanpa Kabel Listrik

LED Flashlight
Lampu Buluh LED
LED 照明灯

Vacuum Cleaner
Penyedot Vakum
吸尘器

Drilling | Fastening
Genset / Pengisian
钻孔 / 充电

Impact Drilling | Demolition
Genset / Pemecah
钻孔 / 拆除

Cutting
Pemotong

Grinding | Sanding
Penggosok / Poles
磨削 / 打磨

Sawing
Gergaji
锯切

Planing | Routing
Perataan / Troggam
刨削 / 铣削

Others
Lain-lain
其他

Outdoor Power Equipment
Alat-alat Kerja Luar
户外工具

Makita
19111



DS5000 16mm (5/8")

411

Drill
Gerudi
电钻



- **Powerful 750W motor for improved mixing and drilling performance**
Motor berkuasa 750W untuk prestasi pencampuran dan penggerudian yang lebih baik
强劲的750W马达提高混合和钻孔性能



Standard Equipment: Chuck Key, Top Grip



Continuous Rating Input Input Kuasa Berterusan 额定输入功率	750W
Capacity Kapasiti 能力	Steel: 16mm (5/8") Wood: 36mm (1-7/16")
No Load Speed (RPM) Kelajuan Tanpa Beban 回转数	600
Dimensions (L x W x H) Dimensi 体积	348x83x401mm (13-3/4"x3-1/4"x15-3/4")
Net Weight Berat Bersih 净重	3.0kg (6.6lbs)
Power Supply Cord Kabel Wayar 电源线	2.5m (8.2ft)

DS4012 13mm (1/2")

411

Drill
Gerudi
电钻



- **All-ball bearing construction for durability and longer tool life**
Struktur gelas bola untuk memanjangkan hayat alat
滚珠轴承结构延长工具寿命



Standard Equipment: Chuck Key, Top Grip



Continuous Rating Input Input Kuasa Berterusan 额定输入功率	750W
Capacity Kapasiti 能力	Steel: 13mm (1/2") Wood: 36mm (1-7/16")
No Load Speed (RPM) Kelajuan Tanpa Beban 回转数	0-600
Dimensions (L x W x H) Dimensi 体积	340x83x390mm (13-3/8"x3-1/4"x15-3/8")
Net Weight Berat Bersih 净重	2.8kg (6.2lbs)
Power Supply Cord Kabel Wayar 电源线	2.5m (8.2ft)

6016 16mm (5/8")

51

Drill
Gerudi
电钻



- **D-handle rotates 360 degrees for multi-position operation**
Pemegang-D berputar 360° memudahkan operasi
360° 旋转D型手柄方便操作



Standard Equipment: Chuck Key, Depth Gauge, Top Grip

Continuous rating input Input Kuasa Berterusan 额定输入功率	480W
Capacity Kapasiti 能力	Steel: 16mm (5/8") Wood: 36mm (1-3/8")
No Load Speed (RPM) Kelajuan Tanpa Beban 回转数	700
Overall Length Panjang Keseluruhan 总长度	365mm (14-3/8")
Net weight Berat Bersih 净重	4.4kg (9.7lbs)
Power supply cord Kabel Wayar 电源线	2.5m (8.2ft)

DRILLING | FASTENING

DA3010F 10mm (3/8")

419

Angle Drill Gerudi Sudut 角向电钻



- **Powerful 450W motor with less weight**
Motor berkuasa 450W dan ringan
轻量且强劲的450W马达



Continuous Rating Input Input Kuasa Berterusan 额定输入功率	450W
Capacity Kapasiti 能力	Steel: 10mm (3/8") Wood: 25mm (1")
No Load Speed (RPM) Kelajuan Tanpa Beban 回转数	0-2,400
Overall Length Panjang Keseluruhan 总长度	270mm (10-5/8")
Net Weight Berat Bersih 净重	1.6kg (3.5lbs)
Power Supply Cord Kabel Wayar 电源线	2.5m (8.2ft)

Standard Equipment: Chuck Key, Side grip 36 complete



TD0100

419

Impact Driver Pemutar Skru Impak 冲击螺丝起子机



- **Impacting mechanism for secure fastening**
Mekanisme impak untuk pengetatan yang kukuh
冲击机构确保紧固



Continuous rating input Input Kuasa Berterusan 额定输入功率	230W
Capacity Kapasiti 能力	Machine Screw: M4 - M8 (5/32" - 5/16") Standard Bolt: M5 - M14 (3/16" - 9/16") High Tensile Bolt: M5 - M10 (3/16" - 3/8") Coarse thread (in length): 22 - 90mm (7/8" - 3-1/2")
Driving Shank (Hex) Hex Memandu Aci 六角驱动轴	6.35mm (1/4")
Impacts Per Minute (IPM) Impak Per Minit 冲击数	0 - 3,200
No Load Speed (RPM) Kelajuan Tanpa Beban 回转数	0 - 3,600
Max Fastening Torque Maksimum Tenaga Pemutaran Pengancing 最快扭力	100N-m (74ft.lbs.)
Dimensions (L x W x H) Dimensi 体积	218x60x180mm (8-5/8"x2-3/8"x7-1/8")
Net weight Berat Bersih 净重	0.96kg (2.1lbs)
Power supply cord Kabel Wayar 电源线	2.5m (8.2ft)

Standard Equipment: Phillips Bit

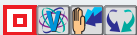

TD0101F

411

Impact Driver Pemutar Skru Impak 冲击螺丝起子机



- **Enables to drive screws even without pre-drilling pilot holes**
Skru boleh digerudi walaupun tanpa lubang pra-penggerudian
即使没有预钻导孔也可以驱动螺钉



Continuous rating input Input Kuasa Berterusan 额定输入功率	230W
Capacity Kapasiti 能力	Machine Screw: M4 - M8 (5/32" - 5/16") Standard Bolt: M5 - M14 (3/16" - 9/16") High Tensile Bolt: M5 - M10 (3/16" - 3/8") Coarse thread (in length): 22 - 90mm (7/8" - 3-1/2")
Driving Shank (Hex) Hex Memandu Aci 六角驱动轴	6.35mm (1/4")
Impacts Per Minute (IPM) Impak Per Minit 冲击数	0 - 3,200
No Load Speed (RPM) Kelajuan Tanpa Beban 回转数	0 - 3,600
Max Fastening Torque Maksimum Tenaga Pemutaran Pengancing 最快扭力	100N-m (74ft.lbs.)
Dimensions (L x W x H) Dimensi 体积	184x67x192mm (7-1/4"x2-5/8"x7-9/16")
Net weight Berat Bersih 净重	0.99kg (2.2lbs)
Power supply cord Kabel Wayar 电源线	2.5m (8.2ft)

Standard Equipment: Phillips Bit



FS2300

419

Drywall Screwdriver Pemutar Skru Drywall 石膏板螺丝起子机



- **Large trigger with lock-on button for operator convenience**
Butang pencetus dengan fungsi mengunci untuk memudahkan pengguna
备有锁定功能的触发按钮方便操作



Continuous Rating Input Input Kuasa Berterusan 额定输入功率	570W
Capacity Kapasiti 能力	Drywall Screw: 5mm (3/16") Self-Drilling Screw: 6mm (1/4")
Driving Shank (Hex) Hex Memandu Aci 六角驱动轴	6.35mm (1/4")
No Load Speed (RPM) Kelajuan Tanpa Beban 回转数	0 - 2,500
Dimensions (L x W x H) Dimensi 体积	290x70x207mm (11-3/8"x2-3/4"x8-1/8")
Net Weight Berat Bersih 净重	1.6kg (3.5lbs)
Power Supply Cord Kabel Wayar 电源线	2.5m (8.2ft.)

Standard Equipment: Phillips Insert Bit x2, Magnetic Bit Holder



FS2500

419

Screwdriver Pemutar Skru 螺丝起子机



- **Aluminum gear housing for less weight and increased durability**
Lebih tahan lama dan ringan dengan gear aluminium
铝合金齿轮更轻更耐用



Continuous Rating Input Input Kuasa Berterusan 额定输入功率	570W
Capacity Kapasiti 能力	Drywall Screw: 5mm (3/16") Self-Drilling Screw: 6mm (1/4")
Driving Shank (Hex) Hex Memandu Aci 六角驱动轴	6.35mm (1/4")
No Load Speed (RPM) Kelajuan Tanpa Beban 回转数	0 - 2,500
Dimensions (L x W x H) Dimensi 体积	280x70x207mm (11"x2-3/4"x8-1/8")
Net Weight Berat Bersih 净重	1.5kg (3.4lbs)
Power Supply Cord Kabel Wayar 电源线	2.5m (8.2ft.)

Standard Equipment: Magnetic Socket Bit



Cordless
Tangpa Hood / 无线

LED Flashlight
Lampu Cahaya LED
LED 闪光灯

Vacuum Cleaner
Penyedut Vakuum
吸尘器

Drilling / Fastening
Gerudi / Pemutar
钻孔 / 紧固

Impact Drilling / Demolition
Gerudi / Pemusnah
冲击钻孔 / 拆除

Cutting
Pemotong
切割

Grinding / Sanding
Pergilas / Pasir
磨削 / 打磨

Saving
Ganyu
锯切

Planing / Routing
Pegayaan / Tanggapan
刨削 / 雕刻

Others
Lain-lain
其他

Outdoor Power Equipment
Alatan Kuasa Luar
户外动力设备

Makita
1 INT

Drilling | Fastening

FS2700

419 W

Screwdriver
Pemutar Skru
螺丝起子机



- 6 stage adjustable torque adjustment for a wide range of applications
6 tahap pelarasan tork untuk pelbagai aplikasi
6级扭力调节适合各种应用



Continuous Rating Input Input Kuasa Berterusan 额定输入功率	570W
Capacity Kapasiti 能力	Self-Drilling Screw: 6mm (1/4") Machine Screw: 8mm (5/16") Wood Screw: 6.2mm (1/4")
Driving Shank (Hex) Hex Memandu Aci 六角驱动轴	6.35mm (1/4")
No Load Speed (RPM) Kelajuan Tanpa Beban 回转速数	0 - 2,500
Dimensions (L x W x H) Dimensi 体积	301x70x207mm (11-7/8"x2-3/4"x8-1/8")
Net Weight Berat Bersih 净重	1.8kg (4lbs)
Power Supply Cord Kabel Wayar 电源线	2.5m (8.2ft.)

FS4200

419 W

Drywall Screwdriver
Pemutar Skru Papan Gypsum
石膏板螺丝起子机



- Powerful 570W motor
Motor berkuasa 570W
570W强力马达

Standard Equipment: Phillips Insert Bit x2, Magnetic Bit Holder



Continuous Rating Input Input Kuasa Berterusan 额定输入功率	570W
Capacity Kapasiti 能力	Drywall Screw: 5mm (3/16") Self-Drilling Screw: 6mm (1/4") 6.35mm (1/4")
Driving Shank (Hex) Hex Memandu Aci 六角驱动轴	6.35mm (1/4")
No Load Speed (RPM) Kelajuan Tanpa Beban 回转速数	0 - 4,000
Dimensions (L x W x H) Dimensi 体积	269x65x207mm (10-5/8"x2-9/16"x8-1/8")
Net Weight Berat Bersih 净重	1.4kg (3lbs)
Power Supply Cord Kabel Wayar 电源线	2.5m (8.2ft.)

FS6300

419 W

Drywall Screwdriver
Pemutar Skru Papan Gypsum
石膏板螺丝起子机



- Silent clutch for improved performance and durability
Klacc senyap untuk prestasi dan ketahanan yang lebih baik
静音离合器提高性能和耐用性

Standard Equipment: Phillips Insert Bit x2, Magnetic Bit Holder



Continuous Rating Input Input Kuasa Berterusan 额定输入功率	570W
Capacity Kapasiti 能力	Drywall Screw: 4mm (5/32")
Driving Shank (Hex) Hex Memandu Aci 六角驱动轴	6.35mm (1/4")
No Load Speed (RPM) Kelajuan Tanpa Beban 回转速数	0 - 6,000
Dimensions (L x W x H) Dimensi 体积	279x65x207mm (11"x2-9/16"x8-1/8")
Net Weight Berat Bersih 净重	1.4kg (3.1lbs)
Power Supply Cord Kabel Wayar 电源线	2.5m (8.2ft.)



Cordless
Terasa Mudah Diguna

LED Flashlight
Lampu Buluh LED
LED 照明灯

Vacuum Cleaner
Penyedut Vakuum
吸尘器

Drilling | Fastening
Gores | Pasang
钻孔 | 紧固

Impact Drilling | Demolition
Gimul | Persekit
冲击钻孔 | 拆除加工

Cutting
Memotong
切割

Grinding | Sanding
Mengisar | Mengkilap
磨削 | 打磨

Sawing
Gores
切割

Planing | Routing
Perjalanan | Tengking
刨削 | 修边

Others
Lain-lain
其他

Outdoor Power Equipment
Alatan Kerja Luar
园机产品



DRILLING | FASTENING

UT1305

303 mm

Mixer

Pengadun
搅拌机



- Heavy duty and high speed mixer
Tahan lasak dan kelajuan tinggi
耐用和高速

Standard Equipment: Wrenches, Side Grip, Blade



Continuous Rating Input Input Kuasa Berterusan 额定输入功率	850W
Blade Diameter Diameter Bilah 刀片直径	165mm (6-1/2")
No Load Speed (RPM) Kelajuan Tanpa Beban 回转数	1,300
Shank Size of Tool Holder Portion Batang Saiz 柄部尺寸	M12
Dimensions (L x W x H) Dimensi 体积	942x87x152mm (37"x3-7/16"x6")
Net Weight Berat Bersih 净重	2.6kg (5.7lbs)
Power Supply Cord Kabel Wayar 电源线	2.5m (8.2ft)

UT2204

303 mm

Mixer

Pengadun
搅拌机



- Heavy duty and high speed mixer
Tahan lasak dan kelajuan tinggi
耐用和高速

Standard Equipment: Wrenches, Side Grip



Continuous rating input Input Kuasa Berterusan 额定输入功率	850W
Blade Diameter Diameter Bilah 刀片直径	220mm (8-5/8")
No Load Speed (RPM) Kelajuan Tanpa Beban 回转数	550
Shank Size of Tool Holder Portion Batang Saiz 柄部尺寸	M12 or M14
Dimensions (L x W x H) Dimensi 体积	929x89x152mm (36-1/2"x3-1/2"x6")
Net weight Berat Bersih 净重	2.7kg (5.9lbs)
Power supply cord Kabel Wayar 电源线	2.5m (8.2ft)

TW1000 25.4mm (1")

153 mm

Impact Wrench

Perengkuh Impak
套筒扳手



- Huge 1,000N·m (738 ft.lbs.) of Power for Industrial Applications
Kuasa 1,000N·m (738 ft.lbs.) untuk aplikasi perindustrian
巨大的 1,000N·m (738 ft.lbs.) 功率适合工业应用

Standard Equipment: Side Grip, Socket



Continuous Rating Input Input Kuasa Berterusan 额定输入功率	1,200W
Fastening Capacities Kapasiti 能力	Standard Bolt: M24 - M30 (15/16" - 1-3/16") High Tensile Bolt: M22 - M24 (7/8" - 15/16")
Square Drive Batang Segi Empat 四方头	25.4mm (1")
No Load Speed (RPM) Kelajuan Tanpa Beban 回转数	1,400
Impacts Per Minute (IPM) Impak Per Minit 冲击数	1,500
Max Fastening Torque Maksimum Tenaga Pemutaran Pengancing 最快扭力	1,000N·m (738ft.lbs.)
Dimensions (L x W x H) Dimensi 体积	382x110x290mm (15"x4-5/16"x11-3/8")
Net Weight Berat Bersih 净重	8.8kg (19.4lbs)
Power Supply Cord Kabel Wayar 电源线	2.5m (8.2ft)

6906 19mm (3/4")

100 mm

Impact Wrench

Perengkuh Impak
套筒扳手



- Powerful 850W motor
Motor berkuasa 850W
强大的850W马达

Standard Equipment: Side Grip, Socket



Continuous Rating Input Input Kuasa Berterusan 额定输入功率	850W
Capacity Kapasiti 能力	Standard Bolt: M16 - M22 (5/8" - 7/8") High Tensile Bolt: M16 - M20 (5/8" - 3/4")
Square Drive Batang Segi Empat 四方头	19mm (3/4")
No Load Speed (RPM) Kelajuan Tanpa Beban 回转数	1,700
Impacts Per Minute (IPM) Impak Per Minit 冲击数	1,600
Max Fastening Torque Maksimum Tenaga Pemutaran Pengancing 最快扭力	588 N·m (441ft.lbs.)
Overall Length Dimensi 体积	327mm (12-7/8")
Net Weight Berat Bersih 净重	5.6kg (12.2lbs)
Power Supply Cord Kabel Wayar 电源线	2.5m (8.2ft)

6905B 12.7mm (1/2")

65 mm

Impact Wrench

Perengkuh Impak
套筒扳手



- Aluminum hammer case with high durability
Casing aluminium yang bertahan
铝制外壳更耐用

Standard Equipment: Socket 19, 22, 24



Continuous Rating Input Input Kuasa Berterusan 额定输入功率	440W
Fastening Capacities Kapasiti 能力	Standard Bolt: M12 - M20 (1/2" - 3/4") High Tensile Bolt: M12 - M16 (1/2" - 5/8")
Square Drive Batang Segi Empat 四方头	12.7mm (1/2")
No Load Speed (RPM) Kelajuan Tanpa Beban 回转数	1,700
Impacts Per Minute (IPM) Impak Per Minit 冲击数	2,000
Max Fastening Torque Maksimum Tenaga Pemutaran Pengancing 最快扭力	294N·m (217ft.lbs.)
Overall Length Dimensi 体积	270mm (10-5/8")
Net Weight Berat Bersih 净重	2.8kg (6.2lbs)
Power Supply Cord Kabel Wayar 电源线	2.5m (8.2ft)

Cordless
Tanpa Kabel / 无线

LED Flashlight
Lampu Sesebuah LED
LED照明灯

Vacuum Cleaner
Penyedut Vakuum
吸尘器

Drilling / Fastening
Gergaji / Pengasing
钻孔 / 紧固

Impact Drilling / Demolition
Gergaji / Pemusnah
冲击钻孔 / 拆除

Cutting
Pemotong
切割

Grinding / Sanding
Pengisar / Pasir
打磨 / 磨光

Sawing
Gergaji
锯切

Planing / Routing
Pengisar / Tengking
刨平 / 刨花

Others
Lain-lain
其他

Outdoor Power Equipment
Alatan Kuasa Luar
户外动力设备

Thakita
THAKITA

Drilling | Fastening

TW0350 12.7mm (1/2")

411 WATT

Impact Wrench Perengkuh Impak 套筒扳手



- Large, efficient hammer creates more impacts for greater power
Penukil kecekapan tinggi untuk hentaman yang lebih kuat
高效率锤子给予更强的冲击力

Standard Equipment: Socket



Continuous Rating Input Input Kuasa Berterusan 额定输入功率	400W
Fastening Capacities Kapasiti 能力	Standard Bolt: M12 - M22 (1/2" - 7/8") High Tensile Bolt: M12 - M16 (1/2" - 5/8") 12.7mm (1/2")
Square Drive Batang Segi Empat 四方头	
No Load Speed (RPM) Kelajuan Tanpa Beban 回转数	2,000
Impacts Per Minute (IPM) Impak Per Minit 冲击数	2,000
Max Fastening Torque Maksimum Tenaga Pemutaran Pengancing 最快扭力	350N-m (260ft.lbs.)
Dimensions (L x W x H) Dimensi 体积	283x87x233mm (11-1/8"x3-7/16"x9-1/8")
Net Weight Berat Bersih 淨重	3kg (6.6lbs)
Power Supply Cord Kabel Wayar 电源线	2.5m (8.2ft)

TW0200 12.7mm (1/2")

411 WATT

Impact Wrench Perengkuh Impak 套筒扳手



- Compact and lightweight design for use in tight spaces
Sesuai untuk digunakan di ruang kecil
方便用于小空间

Standard Equipment: Socket, Hook



Continuous Rating Input Input Kuasa Berterusan 额定输入功率	380W
Fastening Capacities Kapasiti 能力	Standard Bolt: M10 - M16 (3/8" - 5/8") High Tensile Bolt: M10 - M12 (3/8" - 1/2") 12.7mm (1/2")
Square Drive Batang Segi Empat 四方头	
No Load Speed (RPM) Kelajuan Tanpa Beban 回转数	0 - 2,200
Impacts Per Minute (IPM) Impak Per Minit 冲击数	0 - 2,200
Max Fastening Torque Maksimum Tenaga Pemutaran Pengancing 最快扭力	200N-m (150ft.lbs.)
Dimensions (L x W x H) Dimensi 体积	251x72x220mm (9-7/8"x2-13/16"x8-5/8")
Net Weight Berat Bersih 淨重	2.1kg (4.7lbs)
Power Supply Cord Kabel Wayar 电源线	2.5m (8.2ft)

6922NB M16 (5/8"), M20 (3/4"), M22 (7/8")

411 WATT

Shear Wrench Perengkuh Ricih 扭断式套筒扳手



- Compact and Lightweight Yet Powerful
Kompak dan ringan namun berkuasa
小巧轻便功能强大

Standard Equipment: Screwdriver, Sleeve M20, Sleeve M24



Continuous Rating Input Input Kuasa Berterusan 额定输入功率	1,330W
Capacity Kapasiti 能力	Bolt : M16, M20, M22 (5/8", 3/4", 7/8") 18
No Load Speed (RPM) Kelajuan Tanpa Beban 回转数	18
Max Fastening Torque Maksimum Tenaga Pemutaran Pengancing 最快扭力	804N-m (593ft.lbs.)
Dimensions (L x W x H) Dimensi 体积	249x84x252mm (9-13/16"x3-5/16"x9-15/16")
Net Weight Berat Bersih 淨重	4.9kg (10.8lbs)
Power Supply Cord Kabel Wayar 电源线	2.5m (8.2ft)

6924N M22 (7/8"), M24 (1"), SHTB22

303 WATT

Shear Wrench Perengkuh Ricih 扭断式套筒扳手



- High rotational speed for more efficient operation
Kelajuan putaran tinggi untuk operasi yang lebih cekap
高转速提高操作效率

Standard Equipment: Screwdriver, Sleeve M24



Continuous Rating Input Input Kuasa Berterusan 额定输入功率	1,050W
Capacity Kapasiti 能力	Bolt : M22, M24, 7/8", 1" Super high tensile bolt : M22 19
No Load Speed (RPM) Kelajuan Tanpa Beban 回转数	19
Max Fastening Torque Maksimum Tenaga Pemutaran Pengancing 最快扭力	1,100N-m (810ft.lbs.)
Dimensions (L x W x H) Dimensi 体积	330x104x257mm (13"x4-1/8"x10-1/8")
Net Weight Berat Bersih 淨重	7.5kg (16.6lbs)
Power Supply Cord Kabel Wayar 电源线	2.5m (8.2ft)

HB500 50mm (2")

Magnetic Drill Gerudi Magnet 磁力钻孔机



- Magnetic base, drill stand, and drill machine all in one package system
Dasar bermagnet, mesin dan penagak gerudi dalam satu sistem
磁性底座, 钻架和钻机集在同一系统

Standard Equipment: Quick release arbor, Small oil cup assembly and clip, Safety guard, Polyester safety strap, Integral oil feed steady allen keys



Capacity Kapasiti 能力	Steel: 50mm (2")
Chuck Capacity Kapasiti Chuck 夹头能力	16mm (5/8")
No Load Speed (RPM) Kelajuan Tanpa Beban 回转数	350 / 650
Magnetic Clamping Force Kekuatan Penjepit Magnetik 磁力夹紧力	Minimum 9,300N (950kg)
Dimensions (L x W x H) Dimensi 体积	290x150x450mm (11-3/8"x5-7/8"x17-3/4")
Net Weight Berat Bersih 淨重	18.5kg (40.8lbs)

Cordless
Terasa Mudah Diguna

LED Flashlight
Lampu Buluh LED
LED 照明灯

Vacuum Cleaner
Penarik Debu (Vakum)
吸尘器

Drilling / Fastening
Gores / Pengancing
钻孔 / 紧固

Impact Drilling / Demolition
Gimul / Pemusnah
冲击钻孔 / 拆除加工

Cutting
Pemotong
切割

Grinding / Sanding
Pengisar / Pesih
磨削 / 砂磨

Sawing
Gergaji
锯切

Planing / Routing
Penjalar / Tengking
刨削 / 铣削

Others
Lain-lain
其他

Outdoor Power Equipment
Alatan Kuasa Luar
户外动力设备

Makita
MAKITA

IMPACT DRILLING DEMOLITION

Gerudi | Pemecah 石工钻孔 | 凿裂加工



HP0300 10mm (3/8")

411

Hammer Driver Drill
Tukul Pemutar Skru Bergerudi
冲击螺丝起子电钻

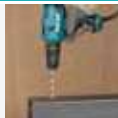

- 2-mode operation for "Rotation Only" or "Hammering with Rotation"
operasi 2 mod, penukulan dengan putaran atau hanya putaran
2档模式变换, 旋转并锤击或仅旋转



Standard Equipment: (+)(-) Bit



Continuous Rating Input Input Kuasa Berterusan 额定输入功率	320W
Capacity Kapasiti 能力	Concrete: 8mm (5/16") Steel: 10mm (3/8") Wood: 28mm (1-1/8")
Chuck Capacity Kapasiti Chuck 夹头能力	1.0 - 10mm (1/32 - 3/8")
Impacts Per Minute (IPM) Impak Per Minit 冲击数	High: 0 - 22,500 Low: 0 - 6,750
No Load Speed (RPM) Kelajuan Tanpa Beban 回转速数	High: 0 - 1,500 Low: 0 - 450
Max Fastening Torque Tenaga Pemutaran Pengancing Maksimum 最大扭矩	Hard 56.0N-m (500in.lbs.) Soft: 21.0N-m (190in.lbs.)
Max Lock Torque Pemutaran Tenaga Maksimum 最大锁定扭力	42.0N-m (370in.lbs.)
Dimensions (L x W x H) Dimensi 体积	235x67x206mm (9-3/8"x2-5/8"x8-1/8")
Net Weight Berat Bersih 净重	1.3kg (2.8lbs.)
Power Supply Cord Kabel Wayar 电源线	2.5m (8.2ft)

HP1230 12mm (15/32")

419

Hammer Drill
Gerudi Tukul
冲击电钻



- 2 operation modes - hammering with rotation and rotation only
Operasi 2-Mod untuk Putaran Hanya atau Hammering with Rotation
仅旋转或旋转锤击的双模式操作



Standard Equipment: Chuck Key, Depth Gauge, Side Grip



Continuous Rating Input Input Kuasa Berterusan 额定输入功率	400W
Capacity Kapasiti 能力	Concrete: 12mm (15/32")/ Steel: 10mm (3/8")/ Wood: 15mm (9/16")
Chuck Capacity Kapasiti Chuck 夹头能力	1.5 - 10mm (1/16 - 3/8")
Impacts Per Minute (IPM) Impak Per Minit 冲击数	0 - 31,900
No Load Speed (RPM) Kelajuan Tanpa Beban 回转速数	0 - 2,900
Dimensions (L x W x H) Dimensi 体积	239x67x188mm (9-3/8"x2-5/8"x7-3/8")
Net Weight Berat Bersih 净重	1.7kg (3.7lbs.)
Power Supply Cord Kabel Wayar 电源线	2.0m (6.6ft)

HP1630 16mm (5/8")

85

Hammer Drill
Gerudi Tukul
冲击电钻



- Lightweight with large drilling capacity up to 16mm in concrete
Ringan dengan kapasiti penggerudian yang besar sehingga 16mm dalam konkrit
轻量, 高能力, 混凝土钻孔达16mm



Standard Equipment: Side Handle, Chuck Key



Continuous Rating Input Input Kuasa Berterusan 额定输入功率	710W
Capacity Kapasiti 能力	Concrete: 16mm (5/8")/ Steel: 13mm (1/2")/ Wood: 30mm (1-3/16")
No Load Speed (RPM) Kelajuan Tanpa Beban 回转速数	0 - 3,200
Impacts Per Minute (IPM) Impak Per Minit 冲击数	0 - 48,000
Dimensions (L x W x H) Dimensi 体积	296x75x204mm (11-5/8"x2-15/16"x8")
Net Weight Berat Bersih 净重	2.1kg (4.6lbs)
Power Supply Cord Kabel Wayar 电源线	2.0m (6.6ft)

Cordless
Terdapat Model Berselek

LED Flashlight
Lampu Flash LED
LTCOR0012

Vacuum Cleaner
Penyedut Vakuum
EVC200

Drilling / Fastening
Gerudi / Pengancing
M12 / M16

Impact Drilling / Demolition
Gerudi / Pemecah
石工钻孔 / 凿裂加工

Cutting
Pemotongan
CUT1

Grinding / Sanding
Penggiliran / Haluskan
G10 / G15

Sawing
Gergaji
G12

Planing / Routing
Pegayaan / Tumpang
G13 / G14

Others
Lain-lain
G15

Outdoor Power Equipment
Alatan Kuasa Luar
G16 - G20

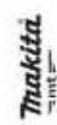

IMPACT DRILLING | DEMOLITION

HP2050 20mm (3/4")

419 W

2-Speed Hammer Drill

Gerudi Tukul
冲击电钻



- **2-Mode operation for Rotation Only or Hammering with Rotation**
Operasi 2-Mod untuk Putaran Hanya atau Hammering with Rotation
仅旋转或旋转锤击的双模式操作

Standard Equipment: Chuck Key, Side Grip, Depth Rod



Continuous Rating Input Input Kuasa Berterusan 额定输入功率	720W
Capacity Kapasiti 能力	Concrete: 20mm (3/4")
	Steel Hi : 8mm (5/16") Steel Lo : 13mm (1/2") Wood Hi : 25mm (1") Wood Lo : 40mm (1-9/16")
Impacts Per Minute (IPM) Kelajuan Tanpa Beban 回转数	High: 0-58,000 Low: 0-24,000
No Load Speed (RPM) Impak Per Minit 冲击数	High: 0-2,900 Low: 0-1,200
Overall Length Panjang Keseluruhan 总长度	362mm (14-1/4")
Net Weight Berat Bersih 净重	2.5kg (5.6lbs)
Power Supply Cord Kabel Wayar 电源线	2.5m (8.2ft)

HR1830 18mm (11/16")

419 W

Rotary Hammer

Tukul Putar
电锤



- **2-Mode operation for Rotation Only or Hammering with Rotation**
Operasi 2-Mod untuk Putaran Hanya atau Hammering with Rotation
仅旋转或旋转锤击的双模式操作

Standard Equipment: Side Grip, Depth Gauge



Continuous Rating Input Input Kuasa Berterusan 额定输入功率	440W
Impact Energy Kekuatan Impak 单次最大锤击力	EPTA-Procedure 05/2009: 1.2J Our experimental conditions: 1.2J
Capacity Kapasiti 能力	Concrete: 18mm (11/16") Concrete (Diamond core bit) : 65mm (2-9/16") Steel: 13mm (1/2") Wood: 24mm (15/16")
Impacts Per Minute (IPM) Impak Per Minit 冲击数	0-5,000
No Load Speed (RPM) Kelajuan Tanpa Beban 回转数	0-1,500
Dimensions (L x W x H) Dimensi 体积	279x66x208mm (10-7/8"x2-5/8"x8-3/16")
Net Weight Berat Bersih 净重	1.9kg (4.2lbs)
Power Supply Cord Kabel Wayar 电源线	2.5m (8.2ft)

SELESAI stok, mungkin ada! 售完即止
WHILE STOCK LAST

HR1840 18mm (11/16")

459 W

Rotary Hammer

Tukul Putar
电锤



- **2-Mode operation for Rotation Only or Hammering with Rotation**
Operasi 2-Mod untuk Putaran Hanya atau Hammering with Rotation
仅旋转或旋转锤击的双模式操作

Standard Equipment: Side Grip, Depth Gauge



Continuous Rating Input Input Kuasa Berterusan 额定输入功率	470W
Impact Energy Kekuatan Impak 单次最大锤击力	EPTA-Procedure 05/2009: 1.4J Our experimental conditions: 1.4J
Capacity Kapasiti 能力	Concrete: 18mm (11/16") Core Bit: 35mm (1-3/8") Diamond Core Bit (Dry Type): 65mm (2-9/16") Steel: 13mm (1/2") Wood: 24mm (15/16")
Impacts Per Minute (IPM) Impak Per Minit 冲击数	0 - 4,800
No Load Speed (RPM) Kelajuan Tanpa Beban 回转数	0 - 2,100
Dimensions (L x W x H) Dimensi 体积	285x75x208mm (11-1/4"x3"x8-3/16")
Net Weight Berat Bersih 净重	2.0 - 2.4kg (4.3 - 5.3lbs)
Power Supply Cord Kabel Wayar 电源线	2.5m (8.2ft.)

HR1841F 18mm (11/16")

459 W

Rotary Hammer

Tukul Putar
电锤



- **2 operation modes - "Hammering with Rotation" and "Rotation" only**
2 mod operasi - "Mengetuk dengan Putaran" dan "Putaran" sahaja
2种操作模式 - "旋转锤击"和"旋转"

Standard Equipment: Side Grip, Depth Gauge



Continuous Rating Input Input Kuasa Berterusan 额定输入功率	470W
Impact Energy Kekuatan Impak 单次最大锤击力	EPTA-Procedure 05/2009: 1.4J Our experimental conditions: 1.4J
Capacity Kapasiti 能力	Concrete: 18mm (11/16") Core Bit: 35mm (1-3/8") Diamond Core Bit (Dry Type): 65mm (2-9/16") Steel: 13mm (1/2") Wood: 24mm (15/16")
Impacts Per Minute (IPM) Impak Per Minit 冲击数	0 - 4,800
No Load Speed (RPM) Kelajuan Tanpa Beban 回转数	0 - 2,100
Dimensions (L x W x H) Dimensi 体积	285x75x208mm (11-1/4"x3"x8-3/16")
Net Weight Berat Bersih 净重	2.0 - 2.5kg (4.5 - 5.4lbs)
Power Supply Cord Kabel Wayar 电源线	2.5m (8.2ft.)

HR2020 20mm (3/4")

419 W

Rotary Hammer

Tukul Putar
电锤



- **2-Mode operation for Rotation Only or Hammering with Rotation**
Operasi 2-Mod untuk hanya putaran, penukulan dengan putaran sahaja
仅旋转或旋转锤击的双模式操作

Standard Equipment: Side Grip, Depth Gauge



Continuous Rating Input Input Kuasa Berterusan 额定输入功率	710W
Capacity Kapasiti 能力	Concrete: 20mm (3/4") Steel: 13mm (1/2") Wood: 32mm (1-1/4")
Impacts Per Minute (IPM) Impak Per Minit 冲击数	0 - 4,050
No Load Speed (RPM) Kelajuan Tanpa Beban 回转数	0 - 1,050
Overall Length Panjang Keseluruhan 总长度	352mm (13-7/8")
Net Weight Berat Bersih 净重	2.3kg (5.1lbs)
Power Supply Cord Kabel Wayar 电源线	4.0m (13.1ft)

Cordless
Tanpa Kawat 无线式

LED Flashlight
Lampu Flash LED
LED 照明灯

Vacuum Cleaner
Penyedut A Vakuum
吸尘器

Drilling / Fastening
General / Umum
钻孔 / 紧固

Impact Drilling / Demolition
General / Umum
冲击钻孔 / 拆除加工

Cutting / Fastening
General / Umum
切割 / 紧固

Grinding / Sanding
General / Umum
磨削 / 打磨

Sawing / Cutting
General / Umum
锯切 / 切割

Planing / Routing
General / Umum
刨削 / 铣削

Others
Lain-lain
其他

Outdoor Power Equipment
Alat-alat Tenaga Luar
户外动力设备

Makita
MAKITA

IMPACT DRILLING | DEMOLITION

HR2320T / X2 23mm (7/8") 325 WATT

Combination Hammer
Tukul Kombinasi
电冲击钻锤



• **3-Mode operation; rotation only, hammering with rotation and hammering only**
operasi 3 mod: hanya putaran, penukulan dengan putaran, penukulan sahaja
3档模式变换: 仅旋转, 旋转并锤击, 仅锤击

Standard Equipment:
HR2320T: Side Handle, Depth Gauge, Quick Change Drill Chuck (194079-2)
HR2320TX2: Side Handle, Depth Gauge, Quick Change Drill Chuck (194079-2), SDS-Plus Drill & Chisel Set (D-46361)

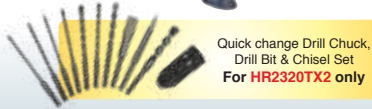

Continuous Rating Input Input Kuasa Berterusan 额定输入功率	720W
Impact Energy Kekuatan Impak 单次最大冲击力	EPTA-Procedure 05/2009: 2.3J Our experimental conditions: 2.6J
Capacity Kapasiti 能力	Concrete: 23mm (7/8") Steel: 13mm (1/2")/ Wood: 32mm (1-1/4") 0 - 4,600
Impacts Per Minute (IPM) Impak Per Minit 冲击数	0 - 1,200
No Load Speed (RPM) Kelajuan Tanpa Beban 回转数	380x77x209mm (15-1/8"x3"x8-1/4")
Dimensions (L x W x H) Dimensi 体积	2.9 - 3.2kg (6.4 - 7.0 lbs)
Net Weight Berat Bersih 净重	2.5m (8.2 ft)
Power Supply Cord Kabel Wayar 电源线	

HR2470X5 24mm (15/16") 325 WATT

Combination Hammer
Tukul Kombinasi
电冲击钻锤



• **3-Mode operation; rotation only, hammering with rotation and hammering only**
operasi 3 mod: hanya putaran, penukulan dengan putaran, penukulan sahaja
3档模式变换: 仅旋转, 旋转并锤击, 仅锤击

Standard Equipment: Side Handle, Depth Gauge, Drill Chuck (194041-7), SDS-Plus Bit Set (D-17784), Bull Point (D-08713)



Continuous Rating Input Input Kuasa Berterusan 额定输入功率	780W
Impact Energy Kekuatan Impak 单次最大冲击力	EPTA-Procedure 05/2009: 2.4J Our experimental conditions: 2.7J
Capacity Kapasiti 能力	Concrete: 24mm (15/16") Core Bit: 54mm (2-1/8") Steel: 13mm (1/2") Wood: 32mm (1-1/4") 0 - 4,500
Impacts Per Minute (IPM) Impak Per Minit 冲击数	0 - 1,100
No Load Speed (RPM) Kelajuan Tanpa Beban 回转数	370x84x214mm (14-1/2"x3-5/16"x8-3/8")
Dimensions (L x W x H) Dimensi 体积	2.9 - 3.3kg (6.4 - 7.3lbs)
Net Weight Berat Bersih 净重	4.0m (13.1ft)
Power Supply Cord Kabel Wayar 电源线	

HR2631FTX2 26mm (1") 325 WATT

Combination Hammer
Tukul Kombinasi
电冲击钻锤



• **3-Mode operation; rotation only, hammering with rotation and hammering only**
operasi 3 mod: hanya putaran, penukulan dengan putaran, penukulan sahaja
3档模式变换: 仅旋转, 旋转并锤击, 仅锤击

Standard Equipment: Side Handle, Depth Gauge, Quick Change Drill Chuck, SDS-Plus Drill & Chisel Set

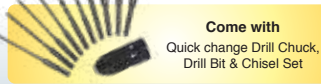

Continuous Rating Input Input Kuasa Berterusan 额定输入功率	800W
Impact Energy Kekuatan Impak 单次最大冲击力	EPTA-Procedure 05/2009: 2.4J Our experimental conditions: 2.9J
Capacity Kapasiti 能力	Concrete: 26mm (1") Core Bit: 68mm (2-11/16") Diamond Core Bit (Dry Type): 80mm (3-1/8") Steel: 13mm (1/2")/ Wood: 32mm (1-1/4") 0 - 4,600
Impacts Per Minute (IPM) Impak Per Minit 冲击数	0 - 1,200
No Load Speed (RPM) Kelajuan Tanpa Beban 回转数	385x77x209mm (15-1/8"x3"x8-1/4")
Dimensions (L x W x H) Dimensi 体积	3.1 - 3.6kg (6.8 - 7.9lbs)
Net Weight Berat Bersih 净重	2.5m (8.2ft)
Power Supply Cord Kabel Wayar 电源线	

HR2611FT 26mm (1") 325 WATT

Combination Hammer
Tukul Kombinasi
电冲击钻锤



• **Extremely low vibration achieved by Anti-Vibration Technology**
Getaran rendah dengan Teknologi anti-getaran AVT
AVT防振技术降低振动

Getaran alok, rendah, atau 告完即止
WHILE STOCK LAST

Standard Equipment: Side Grip, Depth Gauge, Quick Change Drill Chuck



Continuous Rating Input Input Kuasa Berterusan 额定输入功率	800W
Impact Energy Kekuatan Impak 单次最大冲击力	2.4J
Capacity Kapasiti 能力	Concrete: 26mm (1") Steel: 13mm (1/2")/ Wood: 32mm (1-1/4") 0-4,600
Impacts Per Minute (IPM) Impak Per Minit 冲击数	0-1,200
No Load Speed (RPM) Kelajuan Tanpa Beban 回转数	385x77x209mm (15-1/8"x3"x8-1/4")
Dimensions (L x W x H) Dimensi 体积	3.0kg (6.6lbs)
Net Weight Berat Bersih 净重	2.5m (8.2ft)
Power Supply Cord Kabel Wayar 电源线	

HR2630X3 26mm (1") 325 WATT

Combination Hammer
Tukul Kombinasi
电冲击钻锤



• **3-Mode operation; rotation only, hammering with rotation and hammering only**
operasi 3 mod: hanya putaran, penukulan dengan putaran, penukulan sahaja
3档模式变换: 仅旋转, 旋转并锤击, 仅锤击

Standard Equipment: Side Handle, Depth Gauge, Drill Chuck, SDS-Plus Drill & Chisel Set



Continuous Rating Input Input Kuasa Berterusan 额定输入功率	800W
Impact Energy Kekuatan Impak 单次最大冲击力	EPTA-Procedure 05/2009: 2.4J Our experimental conditions: 2.9J
Capacity Kapasiti 能力	Concrete: 26mm (1") Core Bit: 68mm (2-11/16") Diamond Core Bit (Dry Type): 80mm (3-1/8") Steel: 13mm (1/2") Wood: 32mm (1-1/4") 0 - 4,600
Impacts Per Minute (IPM) Impak Per Minit 冲击数	0 - 1,200
No Load Speed (RPM) Kelajuan Tanpa Beban 回转数	385x77x209mm (15-1/8"x3"x8-1/4")
Dimensions (L x W x H) Dimensi 体积	2.8 - 3.3kg (6.3 - 7.2lbs)
Net Weight Berat Bersih 净重	2.5m (8.2ft)
Power Supply Cord Kabel Wayar 电源线	

Cordless
Tempa Akuat BATERAI

LED Flashlight
Lampu Strob LED
LIFEBLOCK

Vacuum Cleaner
Penyedut Vakuum
ELECTRIC

Drilling / Fastening
Gergaji / Pengikat
BETON / BAJA

Impact Drilling / Demolition
Gergaji / Pemusnah
BETON / BAJA

Cutting
Pemotong
BETON

Grinding / Sanding
Pengisar / Hujung
BETON / BAJA

Sawing
Gergaji
BETON

Planing / Routing
Pogolan / Tumpang
BETON / BAJA

Others
Lain-lain
BETON

Outdoor Power Equipment
Alatan Kuasa Luar
BETON / BAJA

Makita
1915

IMPACT DRILLING | DEMOLITION

Large Fan Provides Incredibly High Dust Extraction Power

Kipas besar untuk kuasa ekstraksi habuk yang sangat tinggi
大风扇提供令人难以置信的高除尘能力



65 mm



Equipped with HEPA Filter

Dilengkapi dengan Penapis HEPA 配备 HEPA 过滤器

which removes particles with an efficiency rating of 99.75% from the air passing through

yang menghilangkan zarah dengan penarafan kecekapan 99.75% dari udara yang melalui
从通过的空气中去除效率等级为99.75%的颗粒

HR2652 26mm (1")

325 W

Combination Hammer with Self Dust Collection

Tukul Kombinasi dengan Sistem Pengumpulan Habuk
电冲击钻锤与集尘系统

• See-through dust case for easy checking of collected dust amount

Tahap pengumpulan habuk mudah dilihat dengan kotak habuk lutsinar
透视集尘盒方便检查集尘量



Standard Equipment: Side Grip, Depth Gauge, Sealing Cap



Continuous Rating Input Input Kuasa Berterusan 额定输入功率	800W
Impact Energy Kekuatan Impak 单次最大锤击力	EPTA-Procedure 05/2009: 2.2J Our experimental conditions: 2.9J
Capacity Kapasiti 能力	Concrete: 26mm (1")/ Core Bit: 68mm (2-11/16")/ Diamond Core Bit: 80mm (3-1/8")/ Steel: 13mm (1/2")/ Wood: 32mm (1-1/4")
Impacts Per Minute (IPM) Impak Per Minit 冲击数	0 - 4,600
No Load Speed (RPM) Kelajuan Tanpa Beban 回转数	0 - 1,200
Dimensions (L x W x H) Dimensi 体积	604x89x260mm (23-3/4"x3-1/2"x10-1/4")
Net Weight Berat Bersih 净重	3 - 4.3kg (6.7 - 9.4lbs.)
Power Supply Cord Kabel Wayar 电源线	2.5m (8.2ft.)

HR2810 28mm (1-1/8")

325 W

Combination Hammer

Tukul Kombinasi
电冲击钻锤

• 3-Mode operation; rotation only, hammering with rotation and hammering only

operasi 3 mod: hanya putaran, penukulan dengan putaran, penukulan sahaja
3档模式变换: 仅旋转, 旋转并锤击, 仅锤击



Standard Equipment: Depth Gauge, Side Grip



Continuous Rating Input Input Kuasa Berterusan 额定输入功率	800W
Impact Energy Kekuatan Impak 单次最大锤击力	EPTA-Procedure 05/2009: 2.8J Our experimental conditions: 2.9J
Capacity Kapasiti 能力	Concrete (T.C.T. bit) : 28mm (1-1/8")/ Steel: 13mm (1/2")/ Wood: 32mm (1-1/4")
Impacts Per Minute (IPM) Impak Per Minit 冲击数	0 - 4,500
No Load Speed (RPM) Kelajuan Tanpa Beban 回转数	0 - 1,100
Dimensions (L x W x H) Dimensi 体积	314x89x225mm (12-3/8"x3-1/2"x8-7/8")
Net Weight Berat Bersih 净重	3.4 - 3.8kg (7.5 - 8.5lbs)
Power Supply Cord Kabel Wayar 电源线	2.5m (8.2ft)

HR3210C 32mm (1-1/4")

350 W

Combination Hammer

Tukul Kombinasi
电冲击钻锤

• 3-Mode operation; rotation only, hammering with rotation and hammering only

operasi 3 mod: hanya putaran, penukulan dengan putaran, penukulan sahaja
3档模式变换: 仅旋转, 旋转并锤击, 仅锤击



Standard Equipment: Depth Gauge, Side Grip, Grease vessel

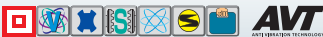

Continuous Rating Input Input Kuasa Berterusan 额定输入功率	850W
Impact Energy Kekuatan Impak 单次最大锤击力	EPTA-Procedure 05/2009: 5J Our experimental conditions: 5.5J
Capacity Kapasiti 能力	Concrete (T.C.T. bit) : 32mm (1-1/4")/ Steel: 13mm (1/2")/ Wood: 32mm (1-1/4")/ Concrete (Core bit) : 90mm (3-1/2")
Impacts Per Minute (IPM) Impak Per Minit 冲击数	1,650 - 3,300
No Load Speed (RPM) Kelajuan Tanpa Beban 回转数	315 - 630
Dimensions (L x W x H) Dimensi 体积	398x114x239mm (15-5/8"x4-1/2"x9-3/8")
Net Weight Berat Bersih 净重	5.2 - 5.6kg (11.4 - 12.4lbs)
Power Supply Cord Kabel Wayar 电源线	5.0m (16.4ft)

HR3200C 32mm (1-1/4")

350 W

Combination Hammer

Tukul Kombinasi
冲击电钻电锤

• 3-Mode operation; rotation only, hammering with rotation and hammering only

operasi 3 mod: hanya putaran, penukulan dengan putaran, penukulan sahaja
3档模式变换: 仅旋转, 旋转并锤击, 仅锤击



Standard Equipment: Depth Gauge, Side Grip, Grease Vessel (181573-3)



Continuous Rating Input Input Kuasa Berterusan 额定输入功率	850W
Impact Energy Kekuatan Impak 单次最大锤击力	EPTA-Procedure 05/2009: 5.1J Our experimental conditions: 5.5J
Capacity Kapasiti 能力	Concrete (T.C.T. bit) : 32mm (1-1/4")/ Steel: 13mm (1/2")/ Wood: 32mm (1-1/4")
Impacts Per Minute (IPM) Impak Per Minit 冲击数	1,650 - 3,300
No Load Speed (RPM) Kelajuan Tanpa Beban 回转数	315 - 630
Dimensions (L x W x H) Dimensi 体积	398x108x239mm (15-5/8"x4-1/4"x9-3/8")
Net Weight Berat Bersih 净重	4.8 - 5.2kg (10.5 - 11.5lbs)
Power Supply Cord Kabel Wayar 电源线	5.0m (16.4ft)

Cordless
Tanpa Kabel 无线式

LED Flashlight
Lampu Flash LED
LED 照明灯

Vacuum Cleaner
Penarik Habuk
吸尘器

Drilling / Fastening
Ganda / Penambat
钻孔 / 紧固

Impact Drilling / Demolition
Ganda / Penambat
冲击钻孔 / 拆除加工

Cutting
Pemotong
切割

Grinding / Sanding
Pengisar / Habis
磨削 / 打磨

Sawing
Gergaji
锯切

Planing / Routing
Pengisar / Pengisar
刨削 / 开槽

Others
Lain-lain
其他

Outdoor Power Equipment
Alatan Kuasa Luar
户外动力设备

Makita
Makita

IMPACT DRILLING | DEMOLITION

HR3530 35mm (1-3/8")

350 W

Rotary Hammer

Tukul Putar
电锤



- Compact and lightweight design
Kompak dan ringan
小巧轻便

Standard Equipment: Side Grip, Depth Gauge



Continuous Rating Input Input Kuasa Berterusan 额定输入功率	1,010W
Impact Energy Kekuatan Impak 单次最大冲击力	Our experimental conditions: 6.2J
Capacity Kapasiti 能力	Concrete (T.C.T. bit) : 35mm (1-3/8")/ Concrete (Core bit) : 105mm (4-1/8")
Impacts Per Minute (IPM) Impak Per Minit 冲击数	3,100
No Load Speed (RPM) Kelajuan Tanpa Beban 回转数	760
Dimensions (L x W x H) Dimensi 体积	374x100x243mm (14-3/4"x3-15/16"x9-9/16")
Net Weight Berat Bersih 净重	5.8kg (12.8lbs)
Power Supply Cord Kabel Wayar 电源线	5.0m (16.4ft)

HR4001C 40mm (1-9/16")

350 W

Rotary Hammer

Tukul Putar
电锤



- 2-Mode operation for Rotation with Hammering or Hammering only
Operasi 2-Mod untuk penukulan dengan putaran, penukulan sahaja
仅锤击或旋转锤击的双模式操作

Standard Equipment: Depth Gauge, Side Grip, Grease vessel



Continuous Rating Input Input Kuasa Berterusan 额定输入功率	1,100W
Impact Energy Kekuatan Impak 单次最大冲击力	EPTA-Procedure 05/2009: 6.8J Our experimental conditions: 9.5J
Capacity Kapasiti 能力	Concrete (T.C.T. bit): 40mm (1-9/16")/ Concrete (Core bit): 105mm (4-1/8")
Impacts Per Minute (IPM) Impak Per Minit 冲击数	1,350-2,750
No Load Speed (RPM) Kelajuan Tanpa Beban 回转数	235-480
Dimensions (L x W x H) Dimensi 体积	468x106x261mm (18-1/2"x4-3/16"x10-1/4")
Net Weight Berat Bersih 净重	5.9kg (13.0lbs)
Power Supply Cord Kabel Wayar 电源线	5.0m (16.4ft)

HR4002 40mm (1-9/16")

350 W

Rotary Hammer

Tukul Putar
电锤



- 2-Mode operation for Rotation with Hammering or Hammering only
Operasi 2-Mod untuk penukulan dengan putaran, penukulan sahaja
仅锤击或旋转锤击的双模式操作

Standard Equipment: Side Grip, Bit Grease, Depth Gauge



Continuous Rating Input Input Kuasa Berterusan 额定输入功率	1,050W
Impact Energy Kekuatan Impak 单次最大冲击力	EPTA-Procedure 05/2009: 6.1J Our experimental conditions: 6.2J
Capacity Kapasiti 能力	Concrete (T.C.T. bit) : 40mm (1-9/16")/ Concrete (Core bit) : 105mm (4-1/8")
Impacts Per Minute (IPM) Impak Per Minit 冲击数	2,500
No Load Speed (RPM) Kelajuan Tanpa Beban 回转数	680
Dimensions (L x W x H) Dimensi 体积	458x114x256mm (18"x4-1/2"x10-1/8")
Net Weight Berat Bersih 净重	6.6 - 6.8kg (14.6 - 15.0lbs)
Power Supply Cord Kabel Wayar 电源线	5.0m (16.4ft)

HR4003C 40mm (1-9/16")

350 W

Rotary Hammer

Tukul Putar
电锤



- 2-Mode operation for Rotation with Hammering or Hammering only
Operasi 2-Mod untuk penukulan dengan putaran, penukulan sahaja
仅锤击或旋转锤击的双模式操作

Standard Equipment: Depth Gauge, Side Handle, Bit Grease, Cloth



Continuous Rating Input Input Kuasa Berterusan 额定输入功率	1,100W
Impact Energy Kekuatan Impak 单次最大冲击力	EPTA-Procedure 05/2009: 8.3J Our experimental conditions: 11.4J
Capacity Kapasiti 能力	Concrete (T.C.T. bit) : 40mm (1-9/16")/ Concrete (Core bit) : 105mm (4-1/8")
Impacts Per Minute (IPM) Impak Per Minit 冲击数	1,450 - 2,900
No Load Speed (RPM) Kelajuan Tanpa Beban 回转数	250 - 500
Dimensions (L x W x H) Dimensi 体积	479x106x263mm (18-11/16"x4-3/16"x10-3/8")
Net Weight Berat Bersih 净重	6.2 - 6.4kg (13.7 - 14.1lbs)
Power Supply Cord Kabel Wayar 电源线	5.0m (16.4ft)

HR4013C 40mm (1-9/16")

350 W

Rotary Hammer

Tukul Putar
电锤



- 2-Mode operation for Rotation with Hammering or Hammering only
Operasi 2-Mod untuk penukulan dengan putaran, penukulan sahaja
仅锤击或旋转锤击的双模式操作

Standard Equipment: Depth Gauge, Side Handle (D), Side Grip, Bit Grease, Cloth



AVT **SOFT**
ANTI-VIBRATION TECHNOLOGY **NO LOAD**

Continuous Rating Input Input Kuasa Berterusan 额定输入功率	1,100W
Impact Energy Kekuatan Impak 单次最大冲击力	EPTA-Procedure 05/2009: 8J Our experimental conditions: 11.4J
Capacity Kapasiti 能力	Concrete (T.C.T. bit) : 40mm (1-9/16")/ Concrete (Core bit) : 105mm (4-1/8")
Impacts Per Minute (IPM) Impak Per Minit 冲击数	1,450 - 2,900
No Load Speed (RPM) Kelajuan Tanpa Beban 回转数	250 - 500
Dimensions (L x W x H) Dimensi 体积	479x112x263mm (18-11/16"x4-3/8"x10-3/8")
Net Weight Berat Bersih 净重	6.8 - 6.9kg (14.9 - 15.3lbs)
Power Supply Cord Kabel Wayar 电源线	5.0m (16.4ft)

Cordless
Tempa Awak Beker

LED Flashlight
Lampu Suhu LED
LICOR 3000

Vacuum Cleaner
Penarik Vakuum
ELECTA

Drilling / Fastening
Gergah / Pasang
MET / 螺絲

Impact Drilling / Demolition
Gergah / Penebuk
Gergah / 螺絲

Cutting
Pemotong
Gergah

Grinding / Sanding
Pengisar / Hujung
Gergah / 螺絲

Sawing
Gergah
Gergah

Planing / Routing
Pogolan / Tumpang
Gergah / 螺絲

Others
Lain-lain
Gergah

Outdoor Power Equipment
Alatan Kerja Luar
Gergah / 螺絲

Makita
Makita

IMPACT DRILLING | DEMOLITION

HR4030C 40mm (1-9/16")

350 **W**

Rotary Hammer

Tukul Putar
电锤



- **2-Mode operation for Rotation with Hammering or Hammering only**
Operasi 2-Mod untuk penukulan dengan putaran, penukulan sahaja
仅锤击或旋转锤击的双模式操作

Standard Equipment: Depth Gauge, Side Grip



Continuous Rating Input Input Kuasa Berterusan 额定输入功率	1,100W
Impact Energy Kekuatan Impak 单次最大锤击力	Our experimental conditions: 9.2J
Capacity Kapasiti 能力	Concrete (T.C.T. bit) : 40mm (1-9/16")/ Concrete (Core bit) : 118mm (4-5/8")
Impacts Per Minute (IPM) Impak Per Minit 冲击数	1,300 - 2,600
No Load Speed (RPM) Kelajuan Tanpa Beban 回转数	230 - 460
Dimensions (L x W x H) Dimensi 体积	413x107x247mm (16-1/4"x4-1/4"x9-3/4")
Net Weight Berat Bersih 净重	6.9kg (15.2lbs)
Power Supply Cord Kabel Wayar 电源线	5.0m (16.4ft)

HR4501C 45mm (1-3/4")

175 **W**

Rotary Hammer

Tukul Putar
电锤



- **High performance and durability**
Prestasi dan ketahanan tinggi
高性能兼耐用

Standard Equipment: Side Handle (D), Side Grip, Depth Gauge, Grease Vessel, Cloth



Continuous Rating Input Input Kuasa Berterusan 额定输入功率	1,350W
Impact Energy Kekuatan Impak 单次最大锤击力	EPTA-Procedure 05/2009: 10.1J Our experimental conditions: 12.5J
Capacity Kapasiti 能力	Concrete (T.C.T. bit) : 45mm (1-3/4")/ Concrete (Core bit) : 125mm (5")
Impacts Per Minute (IPM) Impak Per Minit 冲击数	1,250 - 2,750
No Load Speed (RPM) Kelajuan Tanpa Beban 回转数	130 - 280
Dimensions (L x W x H) Dimensi 体积	458x121x288mm (18"x4-3/4"x11-3/8")
Net Weight Berat Bersih 净重	8.2 - 8.4kg (18.1 - 18.5lbs)
Power Supply Cord Kabel Wayar 电源线	5.0m (16.4ft)

HR4511C 45mm (1-3/4")

175 **W**

Rotary Hammer

Tukul Putar
电锤



- **2-Mode operation for Rotation with Hammering or Hammering only**
Operasi 2-Mod untuk penukulan dengan putaran, penukulan sahaja
仅锤击或旋转锤击的双模式操作

Standard Equipment: Side handle (D), Side Grip, Depth Gauge, Grease Vessel, Cloth



Continuous Rating Input Input Kuasa Berterusan 额定输入功率	1,350W
Impact Energy Kekuatan Impak 单次最大锤击力	EPTA-Procedure 05/2009: 9.4J Our experimental conditions: 12.5J
Capacity Kapasiti 能力	Concrete (T.C.T. bit) : 45mm (1-3/4")/ Concrete (Core bit) : 125mm (5")
Impacts Per Minute (IPM) Impak Per Minit 冲击数	1,250 - 2,750
No Load Speed (RPM) Kelajuan Tanpa Beban 回转数	130 - 280
Dimensions (L x W x H) Dimensi 体积	458x136x288mm (18"x5-3/8"x11-3/8")
Net Weight Berat Bersih 净重	9.0 - 9.1kg (19.8 - 20.1lbs)
Power Supply Cord Kabel Wayar 电源线	5.0m (16.4ft)

HR5202C 52mm (2-1/16")

175 **W**

Rotary Hammer

Tukul Putar
电锤



- **2-Mode operation for Rotation with Hammering or Hammering only**
Operasi 2-Mod untuk penukulan dengan putaran, penukulan sahaja
仅锤击或旋转锤击的双模式操作

Standard Equipment: Side handle (D), Side Grip, Depth Gauge, Grease Vessel, Cloth



Continuous Rating Input Input Kuasa Berterusan 额定输入功率	1,510W
Impact Energy Kekuatan Impak 单次最大锤击力	EPTA-Procedure 05/2009: 19.1J Our experimental conditions: 21J
Capacity Kapasiti 能力	Concrete (T.C.T. bit) : 52mm (2")/ Concrete (Core bit) : 160mm (6-5/16")
Impacts Per Minute (IPM) Impak Per Minit 冲击数	1,100 - 2,250
No Load Speed (RPM) Kelajuan Tanpa Beban 回转数	150 - 310
Dimensions (L x W x H) Dimensi 体积	599x134x287mm (23-1/2"x5-1/4"x11-1/4")
Net Weight Berat Bersih 净重	10.9 - 11.1kg (24.1 - 24.4lbs)
Power Supply Cord Kabel Wayar 电源线	5.0m (16.4ft)

HR5211C 52mm (2-1/16")

175 **W**

Rotary Hammer

Tukul Putar
电锤

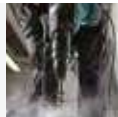

- **2-Mode operation for Rotation with Hammering or Hammering only**
Operasi 2-Mod untuk penukulan dengan putaran, penukulan sahaja
仅锤击或旋转锤击的双模式操作

Standard Equipment: Side handle (D), Side Grip, Depth Gauge, Grease Vessel



Continuous Rating Input Input Kuasa Berterusan 额定输入功率	1,500W
Impact Energy Kekuatan Impak 单次最大锤击力	EPTA-Procedure 05/2009: 18.9J Our experimental conditions: 20J
Capacity Kapasiti 能力	Concrete (T.C.T. bit) : 52mm (2")/ Concrete (Core bit) : 160mm (6-1/4")
Impacts Per Minute (IPM) Impak Per Minit 冲击数	1,075 - 2,150
No Load Speed (RPM) Kelajuan Tanpa Beban 回转数	130 - 260
Dimensions (L x W x H) Dimensi 体积	599x149x287mm (23-1/2"x5-7/8"x11-1/4")
Net Weight Berat Bersih 净重	12.2kg (26.8lbs)
Power Supply Cord Kabel Wayar 电源线	5.0m (16.4ft)

Cordless
Tanpa Kawat / 无线式

LED Flashlight
Lampu Flash LED
LED照明灯

Vacuum Cleaner
Penjerap / 吸尘器

Drilling / Fastening
Gergasi / Penambat
钻孔 / 紧固

Impact Drilling / Demolition
Gergasi / Penambat
冲击钻孔 / 拆除施工

Cutting
Pemotong
切割

Grinding / Sanding
Pengisar / Pasir
磨削 / 打磨

Sawing
Gergasi
切割

Planing / Routing
Pengisar / Pengisar
刨平 / 雕刻

Others
Lain-lain
其他

Outdoor Power Equipment
Alatan Kuasa Luar
户外动力设备

Makita
MAKITA

IMPACT DRILLING | DEMOLITION

HR5212C 52mm (2-1/16")

175 WATT

Rotary Hammer

Tukul Putar
电锤



- **2-Mode operation for Rotation with Hammering or Hammering only**
Operasi 2-Mod untuk penukulan dengan putaran, penukulan sahaja
仅锤击或旋转锤击的双模式操作

Standard Equipment: Side Handle, Side Grip, Depth Gauge, Grease Vessel, Cloth



Continuous Rating Input Input Kuasa Berterusan 额定输入功率	1,510W
Impact Energy Kekuatan Impak 单次最大冲击力	EPTA-Procedure 05/2009: 20J Our experimental conditions: 21J
Capacity Kapasiti 能力	Concrete (T.C.T. bit) : 52mm (2") Concrete (Core bit) : 160mm (6-5/16")
Impacts Per Minute (IPM) Impak Per Minit 冲击数	1,100 - 2,250
No Load Speed (RPM) Kelajuan Tanpa Beban 回转数	150 - 310
Dimensions (L x W x H) Dimensi 体积	599x140x287mm (23-1/2"x5-1/2"x11-1/4")
Net Weight Berat Bersih 净重	11.9 - 12.0kg (26.2 - 26.5lbs)
Power Supply Cord Kabel Wayar 电源线	5.0m (16.4ft)

HM0810TA 17mm (11/16") Hex Shank

105 WATT

Demolition Hammer

Pemahat Tukul Elektrik
电动槌



- **Ideal for light chiseling, chipping and scaling operations**
Sesuai untuk operasi ringan untuk pahatan, penyerpihan dan perskalaan
适用于轻凿击、碎击和铲除原有表面等操作

Standard Equipment: Bull Point, Hex Wrench, Side Grip



Continuous Rating Input Input Kuasa Berterusan 额定输入功率	900W
Impact Energy Kekuatan Impak 单次最大冲击力	EPTA-Procedure 05/2009: 7.2J Our experimental conditions: 7.6J
Impacts Per Minute (IPM) Impak Per Minit 冲击数	2,900
Overall Length Panjang Keseluruhan 总长度	428mm (16-7/8")
Net Weight Berat Bersih 净重	6.3kg (13.9lbs)
Power Supply Cord Kabel Wayar 电源线	5.0m (16.4ft)

HM0870C

350 WATT

Demolition Hammer

Pemahat Tukul Elektrik
电动槌



- **Compact Power with Less Weight**
Kompak dan ringan
紧凑轻量

Standard Equipment: Grease for bit, Side Handle, Cloth



Continuous Rating Input Input Kuasa Berterusan 额定输入功率	1,100W
Impact Energy Kekuatan Impak 单次最大冲击力	EPTA-Procedure 05/2009: 7.6J Our experimental conditions: 11.4J
Impacts Per Minute (IPM) Impak Per Minit 冲击数	1,100 - 2,650
Dimensions (L x W x H) Dimensi 体积	449x109x230mm (17-3/4"x4-1/4"x9")
Net Weight Berat Bersih 净重	5.1 - 5.3kg (11.1 - 11.6lbs)
Power Supply Cord Kabel Wayar 电源线	5.0m (16.4ft)

HM0871C

350 WATT

Demolition Hammer

Pemahat Tukul Elektrik
电动槌



- **High durability and excellent demolition performance**
Ketahanan dan prestasi yang tinggi
高耐用性

Standard Equipment: Grease for bit, Side Handle, Cloth



Continuous Rating Input Input Kuasa Berterusan 额定输入功率	1,100W
Impact Energy Kekuatan Impak 单次最大冲击力	EPTA-Procedure 05/2009: 8.1J Our experimental conditions: 11.6J
Impacts Per Minute (IPM) Impak Per Minit 冲击数	1,100 - 2,650
Dimensions (L x W x H) Dimensi 体积	466x116x230mm (18-3/8"x4-9/16"x9")
Net Weight Berat Bersih 净重	5.6 - 5.8kg (12.4 - 12.8lbs)
Power Supply Cord Kabel Wayar 电源线	5.0m (16.4ft)



Cordless
Terdapat Model Bersekut

LED Flashlight
Lampu Flash LED
LTC0800012

Vacuum Cleaner
Penyedut Vakuum
VTC030

Drilling / Fastening
Gergasi / Pengikat
M12 / M10

Impact Drilling / Demolition
Gergasi / Pemusnah
M12 / M10 / M14

Cutting
Pemotong
M12

Grinding / Sanding
Pengisar / Habis
M12 / M10

Sawing
Gergasi
M12

Planing / Routing
Pegyalan / Tumpang
M12 / M10

Others
Lain-lain
M12

Outdoor Power Equipment
Alatan Kuasa Luar
M12 / M10

Others
Lain-lain
M12

Makita
M12

IMPACT DRILLING | DEMOLITION

Cordless
Tangan Keras
Tangan Keras

LED Flashlight
Lampu Senter LED
Lampu Senter LED

Vacuum Cleaner
Pembersih Vakuum
Pembersih Vakuum

Drilling / Fastening
Genset / Penutup
Genset / Penutup

Impact Drilling / Demolition
Genset / Penutup
Genset / Penutup

Cutting
Pemotong
Pemotong

Grinding / Sanding
Penggosok / Menggosok
Penggosok / Menggosok

Sawing
Gergaji
Gergaji

Planing / Routing
Penggores / Penggores
Penggores / Penggores

Others
Lain-lain
Lain-lain

Outdoor Power Equipment
Alat-alat Tenaga Luar
Alat-alat Tenaga Luar

Makita
Makita

HM1201 21mm (13/16") Hex Shank

155 W

Demolition Hammer
Pemahat Tukul Elektrik
电动槌



- **Powerful impact from durable aluminum body**
Tahan lama dan berkuasa
耐用铝合金机身提供强大的冲击力

Standard Equipment: Bull Point, Hex Wrench, Side Grip



Continuous Rating Input Input Kuasa Berterusan 额定输入功率	1,130W
Impact Energy Kekuatan Impak 单次最大冲击力	Our experimental conditions: 13J
Impacts Per Minute (IPM) Impak Per Minit 冲击数	2,000
Overall Length Panjang Keseluruhan 总长度	480mm (18-7/8")
Net Weight Berat Bersih 净重	9.1kg (20.1lbs)
Power Supply Cord Kabel Wayar 电源线	5.0m (16.4ft)

HM1213C

175 W

Demolition Hammer
Pemahat Tukul Elektrik
电动槌



- **Vibration absorbing handle provides comfortable operation**
Pemegang menyerap getaran untuk operasi yang selesa
吸振手柄提供舒适的操作

Standard Equipment: Bull Point, Bit Grease, Side Handle, Cloth



Continuous Rating Input Input Kuasa Berterusan 额定输入功率	1,510W
Impact Energy Kekuatan Impak 单次最大冲击力	EPTA-Procedure 05/2009: 18.6J Our experimental conditions: 25.5J
Impacts Per Minute (IPM) Impak Per Minit 冲击数	950 - 1,900
Dimensions (L x W x H) Dimensi 体积	576x149x265mm (22-3/4"x5-7/8"x10-3/8")
Net Weight Berat Bersih 净重	10.8kg (23.7lbs)
Power Supply Cord Kabel Wayar 电源线	5.0m (16.4ft)

HM1203C

175 W

Demolition Hammer
Pemahat Tukul Elektrik
电动槌



- **Increasing energy transfer for more power**
Meningkatkan pemindahan tenaga untuk lebih banyak kuasa
增加能量传递以获得更多电力

Standard Equipment: Bull Point, Bit Grease, Side Handle



Continuous Rating Input Input Kuasa Berterusan 额定输入功率	1,510W
Impact Energy Kekuatan Impak 单次最大冲击力	EPTA-Procedure 05/2009: 19.1J Our experimental conditions: 25.5J
Impacts Per Minute (IPM) Impak Per Minit 冲击数	950 - 1,900
Dimensions (L x W x H) Dimensi 体积	576x128x265mm (22-3/4"x5-1/8"x10-3/8")
Net Weight Berat Bersih 净重	9.7kg (21.5lbs)
Power Supply Cord Kabel Wayar 电源线	5.0m (16.4ft)

HM1214C

175 W

Demolition Hammer
Pemahat Tukul Elektrik
电动槌



- **Powerful 1,510W motor**
Motor berkuasa 1,510W
强大马达 1.510W

Standard Equipment: Bull Point, Bit Grease, Side Handle, Cloth



Continuous Rating Input Input Kuasa Berterusan 额定输入功率	1,510W
Impact Energy Kekuatan Impak 单次最大冲击力	EPTA-Procedure 05/2009: 19.9J Our experimental conditions: 26J
Impacts Per Minute (IPM) Impak Per Minit 冲击数	950 - 1,900
Dimensions (L x W x H) Dimensi 体积	700x129x265mm (27-1/2"x5-1/8"x10-3/8")
Net Weight Berat Bersih 净重	12.3kg (27.1lbs)
Power Supply Cord Kabel Wayar 电源线	5.0m (16.4ft)

HM1306 30mm (1-3/16") Hex Shank

204 W

Demolition Hammer
Pemahat Tukul Elektrik
电动槌



- **Powerful 1,510W motor**
Motor berkuasa 1,510W
强大马达 1.510W

Standard Equipment: Bull Point, Wrench, Side Handle, Oil Supply 100ml



Continuous Rating Input Input Kuasa Berterusan 额定输入功率	1,510W
Impact Energy Kekuatan Impak 单次最大冲击力	EPTA-Procedure 05/2009: 21.7J Our experimental conditions: 28.8J
Impacts Per Minute (IPM) Impak Per Minit 冲击数	1,450
Dimensions (L x W x H) Dimensi 体积	652x121x231mm (25-3/4"x4-3/4"x9-1/8")
Net Weight Berat Bersih 净重	15.1kg (33.3lbs)
Power Supply Cord Kabel Wayar 电源线	5.0m (16.4ft)

IMPACT DRILLING | DEMOLITION

HM1317C 30mm (1-3/16") Hex Shank

175

Electric Breaker

Tukul Elektrik
电动锤



- High durability and excellent demolition performance
Ketahanan dan berprestasi tinggi
高耐用性



Standard Equipment: Side Handle



Continuous Rating Input Input Kuasa Berterusan 额定输入功率	1,510W
Impact Energy Kekuatan Impak 单次最大冲击力	EPTA-Procedure 05/2009: 25 (100-127 V: 21) J Our experimental conditions: 33.8 J
Impacts Per Minute (IPM) Impak Per Minit 冲击数	730 - 1,450
Dimensions (L x W x H) Dimensi 体积	715x129x266mm (28-1/8"x5-1/8"x10-1/2")
Net Weight Berat Bersih 净重	17kg (37.5lbs)
Power Supply Cord Kabel Wayar 电源线	5.0m (16.4ft)

HM1307C 30mm (1-3/16") Hex Shank

175

Electric Breaker

Tukul Elektrik
电动锤



- Electronic Controller for Operator Convenience
Kawalan Elektronik memudahkan pengguna
电子控制方便使用



Standard Equipment: Side Handle, Bull Point



Continuous Rating Input Input Kuasa Berterusan 额定输入功率	1,510W
Impact Energy Kekuatan Impak 单次最大冲击力	EPTA-Procedure 05/2009: 25.5J Our experimental conditions: 33.8J
Impacts Per Minute (IPM) Impak Per Minit 冲击数	730 - 1,450
Dimensions (L x W x H) Dimensi 体积	715x129x266mm (28-1/8"x5-1/8"x10-1/2")
Net Weight Berat Bersih 净重	15.3kg (33.8lbs)
Power Supply Cord Kabel Wayar 电源线	5.0m (16.4ft)

HM1810 28.6mm (1-1/8") Hex Shank

204

Electric Breaker

Tukul Elektrik
电动锤



- Powerful 2,000W motor
Motor berkuasa 2,000W
强大马达2,000W



Standard Equipment: Hex Wrench



Continuous Rating Input Input Kuasa Berterusan 额定输入功率	2,000W
Impact Energy Kekuatan Impak 单次最大冲击力	EPTA-Procedure 05/2009: 44.9J Our experimental conditions: 63J
Impacts Per Minute (IPM) Impak Per Minit 冲击数	1,100
Dimensions (L x W x H) Dimensi 体积	824x146x633mm (32-1/2"x5-3/4"x25")
Net Weight Berat Bersih 净重	32.0kg (70.6lbs)
Power Supply Cord Kabel Wayar 电源线	5.0m (16.4ft)

HM1812 28.6mm (1-1/8") Hex Shank

218

Electric Breaker

Tukul Elektrik
电动锤



- Hits like air without the vibration
Tukulan mudah
轻易敲击



Standard Equipment: Bull Point, Hex Wrench



Continuous Rating Input Input Kuasa Berterusan 额定输入功率	2,000W
Impact Energy Kekuatan Impak 单次最大冲击力	EPTA-Procedure 05/2009: 72.8J Our experimental conditions: 62J
Impacts Per Minute (IPM) Impak Per Minit 冲击数	870
Dimensions (L x W x H) Dimensi 体积	843x210x608mm (33-1/4"x8-1/4"x24")
Net Weight Berat Bersih 净重	31.3kg (69lbs)
Power Supply Cord Kabel Wayar 电源线	5.0m (16.4ft)

HK1820

350

Power Scraper

Pengikis Elektrik
电动刮剥机



- Large trigger switch with variable speed control function
Suis pencetus yang besar dengan fungsi kawalan kelajuan
备用变速控制功能的大型触发开关



Standard Equipment: Bull Point, Scaling Chisel, Scaling chisel (for tile), Hook complete

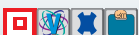

Continuous Rating Input Input Kuasa Berterusan 额定输入功率	550W
Impact Energy Kekuatan Impak 单次最大冲击力	EPTA-Procedure 05/2009: 3.1J Our experimental conditions: 3.9J
Impacts Per Minute (IPM) Impak Per Minit 冲击数	0 - 3,200
Dimensions (L x W x H) Dimensi 体积	351x102x203mm (13-3/4"x4"x8")
Net Weight Berat Bersih 净重	3.4kg (7.5lbs)
Power Supply Cord Kabel Wayar 电源线	5.0m (16.4ft)

Cordless
Tempa Akuat BATERAI

LED Flashlight
Lampu Suhu LED
LTCOR00102

Vacuum Cleaner
Penarik Debu Vacuum
ELECTRIC

Drilling / Fastening
Gergaji / Pengikat
BETON / BESI

Impact Drilling / Demolition
Gergaji / Pemecah
BETON / BESI

Cutting
Pemotong
BETON

Grinding / Sanding
Pengisar / Heksan
BETON / BESI

Sawing
Gergaji
BETON

Planing / Routing
Pogalan / Trajangan
BETON / BESI

Others
Lain-lain
BETON

Outdoor Power Equipment
Alatan Kerja Luar
BETON / BESI

Makita
Makita

Combination / Rotary Hammer Drill Capability Chart

Jadual keupayaan gerudi 钻孔能力表

Tungsten Carbide-tipped usable range
 Recommended range
 Core bits
 ✓✓✓ Optimal
 ✓ Possible

		EPTA Weight (kg)																MATERIAL FOR DRILLING				
		0	10	20	30	40	50	60	70	80	90	100	110	120	130	140	150	160	Highly reinforced concrete	Concrete, granite, stone, brick	Metal/wood	Working direction
14mm series	HR140D	1.9 - 2.6																	✓	✓✓✓	✓	↕
	SDS-plus																					

		EPTA Weight (kg)																MATERIAL FOR DRILLING				
		0	10	20	30	40	50	60	70	80	90	100	110	120	130	140	150	160	Highly reinforced concrete	Concrete, granite, stone, brick	Metal/wood	Working direction
16mm series	DHR165	2.3 - 3.0																	✓	✓✓✓	✓	↕
	SDS-plus		Diamond core 32 (dry type)																			
16mm series	HR166D	1.8 - 2.4																	✓	✓✓✓	✓	↕
	SDS-plus																					

		EPTA Weight (kg)																MATERIAL FOR DRILLING				
		0	10	20	30	40	50	60	70	80	90	100	110	120	130	140	150	160	Highly reinforced concrete	Concrete, granite, stone, brick	Metal/wood	Working direction
17mm series	DHR171	2.1 - 2.8																	✓	✓✓✓	✓	↕
	SDS-plus																					

		EPTA Weight (kg)																MATERIAL FOR DRILLING				
		0	10	20	30	40	50	60	70	80	90	100	110	120	130	140	150	160	Highly reinforced concrete	Concrete, granite, stone, brick	Metal/wood	Working direction
18mm series	HR1841F	2.0 - 2.5																	✓	✓✓✓	✓	↕
	SDS-plus		Diamond core 32 ~ 65 (dry type)																			
18mm series	HR1840	2.0 - 2.5																	✓	✓✓✓	✓	↕
	SDS-plus		Diamond core 32 ~ 65 (dry type)																			
18mm series	HR1830	1.9																	✓	✓✓✓	✓	↕
	SDS-plus		Diamond core 32 ~ 65 (dry type)																			

		EPTA Weight (kg)																MATERIAL FOR DRILLING				
		0	10	20	30	40	50	60	70	80	90	100	110	120	130	140	150	160	Highly reinforced concrete	Concrete, granite, stone, brick	Metal/wood	Working direction
20mm series	DHR202	3.2 - 4.0																	✓	✓✓✓	✓	↕
	SDS-plus		Diamond core 32 (dry type)																			
20mm series	DHR241	3.2 - 4.0																	✓	✓✓✓	✓	↕
	SDS-plus		Diamond core 32 (dry type)																			
20mm series	HR2020	2.6																	✓	✓✓✓	✓	↕
	SDS-plus		Diamond core 32 ~ 65 (dry type)																			

		EPTA Weight (kg)																MATERIAL FOR DRILLING				
		0	10	20	30	40	50	60	70	80	90	100	110	120	130	140	150	160	Highly reinforced concrete	Concrete, granite, stone, brick	Metal/wood	Working direction
22mm series	HR2230	2.6 - 3.1																	✓	✓✓✓	✓	↕
	SDS-plus		Diamond core 32 ~ 65 (dry type)																			

		EPTA Weight (kg)																MATERIAL FOR DRILLING				
		0	10	20	30	40	50	60	70	80	90	100	110	120	130	140	150	160	Highly reinforced concrete	Concrete, granite, stone, brick	Metal/wood	Working direction
23mm series	HR2320T	2.9 - 3.2																	✓	✓✓✓	✓	↕
	SDS-plus		Diamond core 32 ~ 70 (dry type)																			

		EPTA Weight (kg)																MATERIAL FOR DRILLING				
		0	10	20	30	40	50	60	70	80	90	100	110	120	130	140	150	160	Highly reinforced concrete	Concrete, granite, stone, brick	Metal/wood	Working direction
24mm series	DHR242	3.1 - 3.8																	✓	✓✓✓	✓	↕
	SDS-plus		Diamond core 32 ~ 65 (dry type)																			
24mm series	HR2470	2.9 - 3.3																	✓	✓✓✓	✓	↕
	SDS-plus		Diamond core 32 ~ 65 (dry type)																			

				EPTA Weight (kg)	0 10 20 30 40 50 60 70 80 90 100 110 120 130 140 150 160																MATERIAL FOR DRILLING			
																					Highly reinforced concrete	Concrete, granite, stone, brick	Metal/wood	Working direction
26mm series	DHR263		4.1 - 5.1	3.2-26 4-18 35-54																✓	✓✓✓	✓	↕	
	SDS-plus			Diamond core 32 ~ 65 (dry type)																				
26mm series	HR2651		3.0 - 3.2	3.2-26 4-18 35-68																✓	✓✓✓	✓	↕	
	SDS-plus			Diamond core 32 ~ 80 (dry type)																				
26mm series	HR2650		3.0 - 3.2	3.2-26 4-18 35-68																✓	✓✓✓	✓	↕	
	SDS-plus			Diamond core 32 ~ 80 (dry type)																				
26mm series	HR2631FT		2.8 - 3.5	3.2-26 4-18 35-68																✓	✓✓✓	✓	↕	
	SDS-plus			Diamond core 32 ~ 80 (dry type)																				
26mm series	HR2630		2.8 - 3.5	3.2-26 4-18 35-68																✓	✓✓✓	✓	↕	
	SDS-plus			Diamond core 32 ~ 80 (dry type)																				
26mm series	HR2611FT		2.8 - 3.0	3.2-26 4-18 35-68																✓	✓✓✓	✓	↕	
	SDS-plus			Diamond core 32 ~ 80 (dry type)																				

				EPTA Weight (kg)	0 10 20 30 40 50 60 70 80 90 100 110 120 130 140 150 160																MATERIAL FOR DRILLING			
																					Highly reinforced concrete	Concrete, granite, stone, brick	Metal/wood	Working direction
28mm series	HR2810		3.4 - 3.9	3.2-28 6-20 35-80																✓	✓✓✓	✓	↕	
	SDS-plus			Diamond core 32 ~ 80 (dry type)																				

				EPTA Weight (kg)	0 10 20 30 40 50 60 70 80 90 100 110 120 130 140 150 160																MATERIAL FOR DRILLING			
																					Highly reinforced concrete	Concrete, granite, stone, brick	Metal/wood	Working direction
32mm series	HR3210C		4.8 - 5.6	4-32 10-22 35-90																✓	✓✓✓	✓	↕	
	SDS-plus			Diamond core 32 ~ 90 (dry type)																				
32mm series	HR3200C		4.8 - 5.6	4-32 10-22 35-90																✓	✓✓✓	✓	↕	
	SDS-plus			Diamond core 32 ~ 90 (dry type)																				

				EPTA Weight (kg)	0 10 20 30 40 50 60 70 80 90 100 110 120 130 140 150 160																MATERIAL FOR DRILLING			
																					Highly reinforced concrete	Concrete, granite, stone, brick	Metal/wood	Working direction
35mm series	HR3530		5.8	10-35 12-25 25-105																✓✓✓	✓✓✓		↕	
	17mm Hex																							

				EPTA Weight (kg)	0 10 20 30 40 50 60 70 80 90 100 110 120 130 140 150 160																MATERIAL FOR DRILLING			
																					Highly reinforced concrete	Concrete, granite, stone, brick	Metal/wood	Working direction
40mm series	HR4013C		6.2 - 6.9	10-40 16-35 20-105																✓✓✓	✓✓✓		↙	
	SDS-max																							
40mm series	HR4003C		6.2 - 6.9	10-40 16-35 20-105																✓✓✓	✓✓✓		↙	
	SDS-max																							
40mm series	HR4001C		6.3 - 6.7	10-40 16-35 20-105																✓✓✓	✓✓✓		↙	
	SDS-max																							
40mm series	HR4002		6.6 - 6.8	10-40 16-32 20-105																✓✓✓	✓✓✓		↙	
	SDS-max																							
40mm series	HR4030C		6.9	10-40 22-35 25-118																✓✓✓	✓✓✓		↙	
	17mm Hex																							

				EPTA Weight (kg)	0 10 20 30 40 50 60 70 80 90 100 110 120 130 140 150 160																MATERIAL FOR DRILLING			
																					Highly reinforced concrete	Concrete, granite, stone, brick	Metal/wood	Working direction
45mm series	HR4511C		8.9 - 9.1	10-45 22-40 20-125																✓✓✓	✓✓✓		↙	
	SDS-max																							
45mm series	HR4501C		8.9 - 9.1	10-45 22-40 20-125																✓✓✓	✓✓✓		↙	
	SDS-max																							

				EPTA Weight (kg)	0 10 20 30 40 50 60 70 80 90 100 110 120 130 140 150 160																MATERIAL FOR DRILLING			
																					Highly reinforced concrete	Concrete, granite, stone, brick	Metal/wood	Working direction
52mm series	HR5212C		11 - 12	19-52 25-45 20-160																✓✓✓	✓✓✓		↙	
	SDS-max																							
52mm series	HR5202C		11 - 12	19-52 25-45 20-160																✓✓✓	✓✓✓		↙	
	SDS-max																							
52mm series	HR5211C		11.3 - 12.2	19-52 25-45 20-160																✓✓✓	✓✓✓		↙	
	SDS-max																							

Cordless
Tanpa Kabel Listrik

LED Flashlight
Lampu Suling LED
LED 闪光

Vacuum Cleaner
Pembersih Vakum
吸尘器

Drilling / Fastening
Dremel / Pasang
电钻 / 紧固

Impact Drilling / Demolition
Gerus / Perusak
电钻 / 拆除

Cutting
Pemotong
切割

Grinding / Sanding
Giling / Pasir
磨削 / 打磨

Sawing
Gergaji
锯切

Planing / Routing
Penghalan / Trocogan
刨削 / 雕刻

Others
Lain-lain
其他

Outdoor Power Equipment
Alat-alat Listrik
户外动力设备

Makita
Makita

CUTTING

Pemotong 切割



CUTTING (New Material | Masonry | Metal)

4112HS 305mm (12")

204 WATT

Angle Cutter

Mesin Pemotong
切割机



- **Smooth and comfortable cutting**
Pemotongan lancar dan selesa
平滑切割

Standard Equipment: Socket Wrench



Continuous Rating Input Input Kuasa Berterusan 额定输入功率	2,400W
Capacity Kapasiti 能力	Max cutting : 100mm (4")
Blade Diameter Diameter Bilah 锯片直径	305mm (12")
No Load Speed (RPM) Kelajuan Tanpa Beban 回转数	5,000
Overall Length Panjang Keseluruhan 总长度	648mm (25-1/2")
Net Weight Berat Bersih 净重	10.4kg (22.9lbs)
Power Supply Cord Kabel Wayar 电源线	2.5m (8.2ft)

4114S 355mm (14")

204 WATT

Angle Cutter

Mesin Pemotong
切割机



- **Faster cutting for increased productivity**
Pemotongan cepat meningkatkan produktiviti
更快的切割提高生产力

Standard Equipment: Wrench



Continuous Rating Input Input Kuasa Berterusan 额定输入功率	2,400W
Capacity Kapasiti 能力	Max cutting : 125mm (5")
Wheel Diameter Diameter Bilah 锯片直径	355mm (14")
Hole Diameter Diameter Lubang 孔直径	25.4mm (1")
No Load Speed (RPM) Kelajuan Tanpa Beban 回转数	3,500
Dimensions (L x W x H) Dimensi 体积	673x240x329mm (26-1/2"x9-1/2"x13")
Net Weight Berat Bersih 净重	10.8kg (23.9lbs)
Power Supply Cord Kabel Wayar 电源线	2.5m (8.2ft)

SG1251J 125mm (5")

318 WATT

Wall Chaser

Mesin Pemotong Dinding
石材开槽切割机



- **Clean, compact and comfortable**
Bersih, padat dan selesa
干净, 紧凑, 舒适

Standard Equipment: Diamond Wheel x2, Hex Wrench,
Lock Nut Wrench



Continuous Rating Input Input Kuasa Berterusan 额定输入功率	1,400W
Capacity Kapasiti 能力	Depth : 0-30mm (0 - 1-3/16") Width: 6-30mm (1/4 - 1-3/16")
Blade Diameter Diameter Bilah 锯片直径	125mm (5")
No Load Speed (RPM) Kelajuan Tanpa Beban 回转数	10,000
Dimensions (L x W x H) Dimensi 体积	350x151x178mm (13-3/4"x5-15/16"x7")
Net Weight Berat Bersih 净重	4.3kg (9.5lbs)
Power Supply Cord Kabel Wayar 电源线	5.0m (16.4ft)

4131 185mm (7-1/4")

303 WATT

Metal Cutter

Mesin Memotong Logam
金属切割机



- **Powerful 1,100W motor cuts through various types of metal**
Motor berkuasa 1,100W sesuai untuk memotong pelbagai jenis logam
强力1,100W马达可切割多种金属

Standard Equipment: Carbide-Tipped Saw Blade (B-04628),
Hex Wrench, Safety Goggles



Continuous Rating Input Input Kuasa Berterusan 额定输入功率	1,100W
Blade Diameter Diameter Bilah 锯片直径	185mm (7-1/4")
Capacity Kapasiti 能力	Max cutting : 63mm (2-1/2")
No Load Speed (RPM) Kelajuan Tanpa Beban 回转数	3,500
Overall Length Panjang Keseluruhan 总长度	358mm (14-1/8")
Net Weight Berat Bersih 净重	4.8kg (11.3lbs)
Power Supply Cord Kabel Wayar 电源线	2.5m (8.2ft)

CUTTING (New Material | Masonry)

4100NH 110mm (4-3/8")

303

Cutter

Mesin Pemotong
切割机



- **Powerful cutting in stone, masonry, tile & concrete**
Berkuasa untuk memotong batu, masonri, jubin & konkrit
有力的切割石材, 砖石, 瓷砖和混凝土

Standard Equipment: Wrench, Socket Wrench



Continuous Rating Input Input Kuasa Berterusan 额定输入功率	1,300W
Blade Diameter Diameter Bilah 锯片直径	110mm (4-3/8")
Max Cutting Capacity Kapasiti Pemotongan Maksimum 最大切割能力	90°: 34mm (1-3/8")
No Load Speed (RPM) Kelajuan Tanpa Beban 回转数	14,500
Dimensions (L x W x H) Dimensi 体积	234x210x165mm (9-1/4"x8-1/4"x6-1/2")
Net Weight Berat Bersih 净重	2.9kg (6.5lbs)
Power Supply Cord Kabel Wayar 电源线	2.5m (8.2ft)

4100NH2Z 110mm (4-3/8")

303

Cutter

Mesin Pemotong
切割机



- **Bevel-cuts up to 45 degrees**
Potongan serong hingga 45°
45° 斜角切割

Standard Equipment: Wrench, Hex Wrench



Continuous Rating Input Input Kuasa Berterusan 额定输入功率	1,400W
Blade Diameter Diameter Bilah 锯片直径	Max 125mm (Max 5")
Max Cutting Capacity w/ 110mm (4-3/8") wheel Kapasiti Pemotongan Maksimum 最大切割能力	90°: 32.5mm (1-1/4") 45°: 21.5mm (7/8")
Max Cutting Capacity w/ 125mm (5") wheel Kapasiti Pemotongan Maksimum 最大切割能力	90°: 40.0mm (1-9/16") 45°: 27.0mm (1-1/16")
No Load Speed (RPM) Kelajuan Tanpa Beban 回转数	12,200
Dimensions (L x W x H) Dimensi 体积	238x214x169mm (9-3/8"x8-3/8"x6-5/8")
Net Weight Berat Bersih 净重	3kg (6.6lbs)
Power Supply Cord Kabel Wayar 电源线	2.5m (8.2ft)

4100NH3Z 110mm (4-3/8")

303

Cutter

Mesin Pemotong
切割机



- **Specialized for right angle cutting only**
Khusus untuk pemotongan sudut kanan sahaja
专为右斜角切割而设

Standard Equipment: Wrench, Hex Wrench



Continuous Rating Input Input Kuasa Berterusan 额定输入功率	1,300W
Blade Diameter Diameter Bilah 锯片直径	110mm (4-3/8")
Max Cutting Capacity Kapasiti Pemotongan Maksimum 最大切割能力	90°: 32mm (1-1/4")
No Load Speed (RPM) Kelajuan Tanpa Beban 回转数	13,800
Dimensions (L x W x H) Dimensi 体积	227x209x166mm (8-15/16"x8-1/4"x6-1/2")
Net Weight Berat Bersih 净重	2.8kg (6.2lbs)
Power Supply Cord Kabel Wayar 电源线	2.0m (6.6ft)

4100KB 125mm (5")

303

Dustless Cutter

Mesin Pemotong
切割机



- **Powerful 1,400W motor, cutting in stone, masonry, tile, concrete & more**
Motor berkuasa 1,400W, untuk memotong batu, masonri, jubin, konkrit dll
强力1,400W马达适合切割石材, 砖石, 瓷砖, 混凝土等

Standard Equipment: Diamond Wheel (D-38261),
Dust Bag (1267380), Wrench, Hex Wrench



Continuous Rating Input Input Kuasa Berterusan 额定输入功率	1,400W
Blade Diameter Diameter Bilah 锯片直径	125mm (5")
Max Cutting Capacity Kapasiti Pemotongan Maksimum 最大切割能力	40.0mm (1-9/16")
No Load Speed (RPM) Kelajuan Tanpa Beban 回转数	12,200
Dimensions (L x W x H) Dimensi 体积	231x220x179mm (9-1/8"x8-5/8"x7")
Net Weight Berat Bersih 净重	3.0kg (6.6lbs.)
Power Supply Cord Kabel Wayar 电源线	2.5m (8.2ft)

4107R 180mm (7-1/8")

153

Cutter

Mesin Pemotong
切割机



- **Ideal for stone materials (such as granite and marble), concrete and asphalt**
Sesuai untuk bahan batu seperti granit, marmar, konkrit dan asfalt bahan
适用于石材如花岗岩, 大理石, 混凝土和沥青

Standard Equipment: Socket Wrench, Offset Wrench,
Water plug & tube



Continuous Rating Input Input Kuasa Berterusan 额定输入功率	1,400W
Capacity Kapasiti 能力	Max cutting : 60mm (2-3/8")
Blade Diameter Diameter Bilah 锯片直径	180mm (7-1/8")
No Load Speed (RPM) Kelajuan Tanpa Beban 回转数	5,000
Overall Length Panjang Keseluruhan 总长度	370mm (14-9/16")
Net Weight Berat Bersih 净重	6.3kg (14.5lbs)
Power Supply Cord Kabel Wayar 电源线	5.0m (16.4ft)

Cordless
Tepat Untuk 方便

LED Flashlight
Lampu Suhu LED
LED 照明灯

Vacuum Cleaner
Pembersih Vakuum
吸尘器

Drilling / Fastening
Gergasi / Pasang
钻孔 / 紧固

Impact Drilling / Demolition
Gergasi / Romban
冲击钻孔 / 拆除施工

Cutting
Pemotong
切割

Grinding / Sanding
Pengiraian / Halus
打磨 / 砂磨

Sawing
Gergasi
锯切

Planing / Routing
Pengiraian / Tonggah
刨平 / 开槽

Others
Lain-lain
其他

Outdoor Power Equipment
Alatan Kuasa Luar
户外动力设备

Makita
mit

CUTTING (New Material | Masonry | Metal)

LC1230 305mm (12")

203

Metal Cutting Saw
Mesin Memotong Logam
金属型材切割机



• For Cutting in Pipe, Angle Iron, Conduit and More
Untuk pemotongan paip, sesiku besi, konduit dan banyak lagi
用于切割管道, 角铁, 导管等

Standard Equipment: Carbide-Tipped Saw Blade, Socket Wrench, Safety Goggles



Continuous Rating Input Input Kuasa Berterusan 额定输入功率	1,750W
Blade Diameter Diameter Bilah 锯片直径	305mm (12")
Max Cutting Capacity Kapasiti Pemotongan Maksimum 最大切割能力	90°: 115mm (4-1/2") 90°: 75 x 150mm (2-15/16" x 5-7/8") 45°: 90mm (3-1/2") 45°: 85 x 85mm (3-5/16" x 3-5/16")
No Load Speed (RPM) Kelajuan Tanpa Beban 回转数	1,300
Dimensions (L x W x H) Dimensi 体积	516x306x603mm (20-1/4"x12"x23-3/4")
Net Weight Berat Bersih 净重	19.3kg (42.5lbs)
Power Supply Cord Kabel Wayar 电源线	2.5m (8.2ft)

Why Makita Carbide-tipped Metal Cutting saw VS. Abrasive Cutting Saw

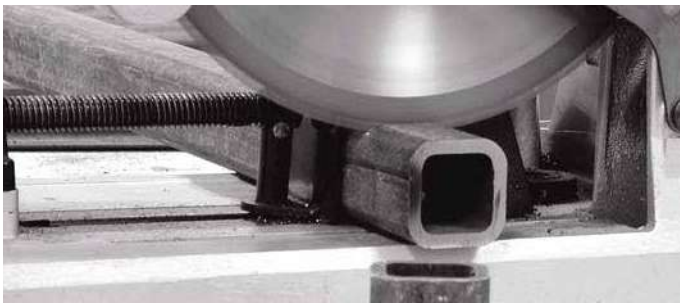

Carbide-Tipped Blades make Virtually Spark-Free Cuts

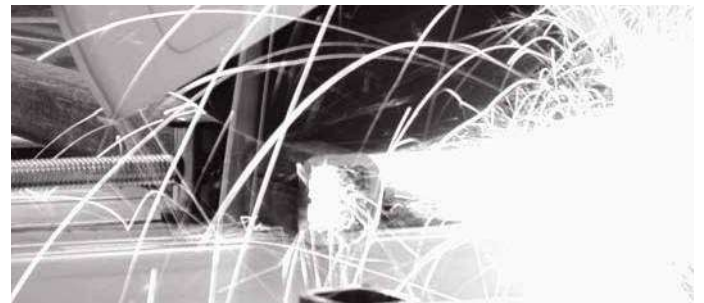

Abrasive Blades make Cuts with Sparks

Makita's Carbide-Tipped Metal Blades Cuts Cleaner

Tubing	Threaded Rod	UNISTRUT™	Angle Iron	Pipe
Makita Carbide-Tipped Blade	Makita Carbide-Tipped Blade	Makita Carbide-Tipped Blade	Makita Carbide-Tipped Blade	Makita Carbide-Tipped Blade
Abrasive Blade	Abrasive Blade	Abrasive Blade	Abrasive Blade	Abrasive Blade

Carbide-Tipped Metal Blades for Many Applications

Applications				Angle		Tubing		Channel		Round Pipe	Stainless Angle	Stainless Tubing
Size (mm)	Tip thickness	Part No.	Nominal thickness	6mm	4mm	3mm	4.5mm	2.3mm	3.2mm	3.8mm	4mm	1.5mm
305 x 60T (Mild steel)	2.1mm	A-87242		○	○	○	△	×	◎	◎	×	×
305 x 60T (Mild steel)	2.5mm	A-81860		○	○	◎	○	×	◎	◎	×	×
305 x 60T (Mild steel) <small>lessend noise</small>	2.4mm	A-86723		◎	◎	◎	○	×	◎	◎	×	×
305 x 78T (Thin steel)	2.3mm	A-87127		△	△	△	×	○	△	△	×	×
305 x 76T (Stainless)	1.95mm	A-87579		○	○	△	×	◎	△	◎	○	○

Cordless
Terdapat Model Tanpa Kabel

LED Flashlight
Lampu Senter LED
LCD/M/MPD

Vacuum Cleaner
Pembersih Vakuum
BLU/CL

Drilling / Fastening
Droptail / Pasang
M/ML / M/ML

Impact Drilling / Demolition
Gigitan / Perseku
M/ML / M/ML

Cutting
Pemotong
M/ML

Grinding / Sanding
Gilingan / Pasir
M/ML / M/ML

Sawing
Gigitan
M/ML

Planing / Routing
Pengaliran / Rongga
M/ML / M/ML

Others
Lain-lain
M/ML

Outdoor Power Equipment
Alat-alat Listrik Luar
M/ML / M/ML

Makita
M/ML

CUTTING (New Material | Masonry | Metal)

Metal Cutting Process

Carbide-Tipped Metal Blade Cutting Tips

- Always wear safety glasses, gloves, protective equipment and follow instructions provided with power tool
- Do not apply excessive pressure on the handle when cutting as damage to the carbide-tips can be a result
- Too little or too much pressure on the handle may result in more sparks and premature blade wear
- Use block spacers when cutting square/rectangle tubing as well as channel and UNISTRUT™ for longer blade life
- When cutting long pieces of metal always use support blocks on both sides so the metal will be level with the saw base
- Do not touch blade or metal immediately after cut

Metal Cutting Process

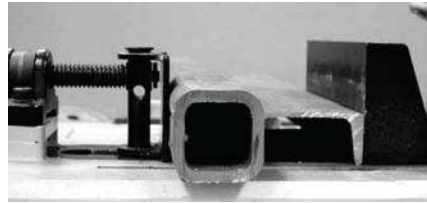

Square & Rectangle Tubing (use block spacer)

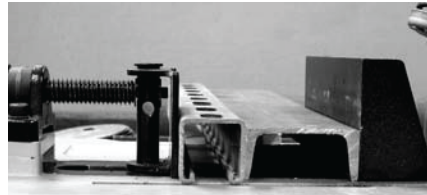

Channels & UNISTRUT™ (use block spacer)

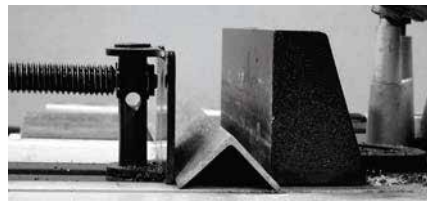

Angle

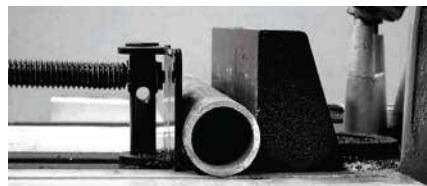

Round Pipe



Threaded Rod

Carbide-Tipped Metal Blade Cutting Tips

- 1 Ensure metal is properly placed on saw base and firmly secured in the saw
- 2 Hold the saw handle firmly and wait until full speed is obtained
- 3 Lower the handle gently to bring the blade close to the metal
- 4 Gently ease the blade into the metal and add minimal pressure (reduce pressure if sparks appear)
- 5 After completed cut, turn off power tool and wait until blade has come to a complete stop then raise the handle back (if handle is raised back with blade still rotating then the blade may be caught)

Block Spacer Reference Chart

Applications	Square & Rectangle Tubing		Round Pipe		Square & Rectangle Tubing		Round Pipe			
	Up to 75 mm	Up to 100 mm	—		Up to 85 mm	—				
<p>Block Spacer</p> <p>Material</p> <p>(mm)</p>	A	B	A	B	A	B	A	B		
	25	125	25	75	25	90	25	60	25	65
90 Degree Cutting	50	100	50	50	50	65	50	35	50	40
	75	75	75	25	75	40	75	10	75	15
	100	50	100	0	100	15	85	0	90	0
	125	25	—	—	115	0	—	—	—	—
	*150	0	—	—	—	—	—	—	—	—
45 Degree Cutting	25	125	25	75	25	90	25	60	25	65
	50	100	50	50	50	65	50	35	50	40
	75	75	75	25	75	40	75	10	75	15
	100	50	100	0	100	15	85	0	90	0
	125	25	—	—	115	0	—	—	—	—

*Hint: Block Spacer should be determined by subtracting the metal width from 150 mm.

Cordless
Target Model: M18C

LED Flashlight
Lampu Senter LED
LECOB0102

Vacuum Cleaner
Penjerap Vakuum
M18C

Drilling / Fastening
Gergaji / Penggulung
M18C / M18C

Impact Drilling / Demolition
Gergaji / Pemecah
M18C / M18C

Cutting / Penetrating
Gergaji
M18C

Grinding / Sanding
Pergasi / Halus
M18C / M18C

Sawing
Gergaji
M18C

Planing / Routing
Pergasi / Tenggang
M18C / M18C

Others
Lain-lain
M18C

Outdoor Power Equipment
Alat-alat Kertas
M18C / M18C

Makita
mit

CUTTING (Metal)

Cordless
Terdapat Model Baterai

LED Flashlight
Lampu Senter LED
(LED Merah)

Vacuum Cleaner
Pembersih Vakum
BLU-DC

Drilling / Fastening
Dremel / Pengencat
M11 / M12

Impact Drilling / Demolition
Gerus / Perusak
M12 / M14 / M16 / M18

Cutting
Pemotong

Grinding / Sanding
Pengamiran / Pasiran
M11 / M12

Sawing
Gergaji

Planing / Routing
Pengaliran / Pengaliran
M11 / M12

Others
Lain-lain
Lain-lain

Outdoor Power Equipment
Alat-alat Tenaga Luar
M11 - M16

Makita
M11 - M16



2107F

Portable Band Saw Pemotong Ringan 轻便带锯



- Built-in fluorescent job light for clear view
Lampu kerja fluoresen terdapat dalam untuk penglihatan jelas
内置荧光工作灯，确保清晰视野

ACCESSORIES (Optional)



Standard Equipment:
Band Saw Blade, Hex Wrench



Portable Band Saw
Stand & Cover
Part No. 196326-7

303

Continuous Rating Input Input Kuasa Berterusan 额定输入功率	710W
Capacity Kapasiti 能力	Round: 120mm (4-3/4") Rectangular workpiece w/o stand: 120x120mm (4-3/4"x4-3/4")
Blade Speed Kelajuan Bilah 刀片速度	60m (200ft) - 105m (350ft) / min
Dimensions (L x W x H) Dimensi 体积	508x188x256mm (20"x7-3/8"x10-1/8")
Net Weight Berat Bersih 净重	6.3kg (13.9lbs)
Power Supply Cord Kabel Wayar 电源线	2.5m (8.2ft)

LW1400 355mm (14")

Portable Cut-off Mesin Pemotong 型材切割机



- Large spark guard prevents backward scattering of spark
Pengawal pencucuk menghalang hamburan mundur dari percikan api
大的火花防护装置可防止火花向后散射

Standard Equipment: Abrasive Cut-Off Wheel



203

Continuous Rating Input Input Kuasa Berterusan 额定输入功率	2,200W
Wheel Diameter Diameter Bilah 锯片直径	355mm (14")
No Load Speed (RPM) Kelajuan Tanpa Beban 回转数	3,800
Capacity at 45° Kapasiti 能力	Round: 127mm (5") Rectangular: 115x103mm (4-1/2"x4-1/16") Square: 106x106mm (4-3/16"x4-3/16") Triangular: 100x100x10mm (4"x4"x3/8")
Dimensions (L x W x H) Dimensi 体积	530x295x640mm (20-7/8"x11-5/8"x25-1/4")
Net Weight Berat Bersih 净重	18.7kg (41.2lbs)
Power Supply Cord Kabel Wayar 电源线	2.5m (8.2ft)

LW1401 355mm (14")

Portable Cut-off Mesin Pemotong 型材切割机



- Powerful 2,200W motor
Motor berkuasa 2,200W
强力2200W马达

Standard Equipment: Abrasive Cut-Off Wheel, Socket Wrench



203

Continuous Rating Input Input Kuasa Berterusan 额定输入功率	2,200W
Wheel Diameter Diameter Bilah 锯片直径	355mm (14")
No Load Speed (RPM) Kelajuan Tanpa Beban 回转数	3,800
Capacity at 45° Kapasiti 能力	Round: 127mm (5") Rectangular: 115x103mm (4-1/2"x4-1/16") Square: 106x106mm (4-3/16"x4-3/16") Triangular: 100x100x10mm (4"x4"x3/8")
Dimensions (L x W x H) Dimensi 体积	500x295x640mm (19-3/4"x11-5/8"x25-1/4")
Net Weight Berat Bersih 净重	18.3kg (40.3lbs)
Power Supply Cord Kabel Wayar 电源线	2.5m (8.2ft)

CUTTING (Metal)

2416S 405mm (16")

Portable Cut-off
Mesin Pemotong
型材切割机



- **Mitres 45° Left And Right**
Potongan miter 45° kiri dan kanan
左右45°斜切割

Standard Equipment: Abrasive Cut-Off Wheel, Socket Wrench



153

Continuous Rating Input Input Kuasa Berterusan 额定输入功率	1,430W
Wheel Diameter Diameter Bilah 锯片直径	405mm (16")
Hole Diameter Diameter Lubang 孔直径	25.4mm (1")
No Load Speed (RPM) Kelajuan Tanpa Beban 回转数	2,300
Dimensions (L x W x H) Dimensi 体积	610x265x535mm (24"x10-3/8"x21")
Net Weight Berat Bersih 净重	19.2kg (42.3lbs)
Power Supply Cord Kabel Wayar 电源线	2.5m (8.2ft)

Model No. 型号	Cutting Angle Sudut Pemotongan 切割角度	Round Pipe Tiub Bulat 圆管	Rectangular Metal Logam Segi Empat Tepat 长方形金属	Square Metal Logam Segi Empat 方形金属	Angle Bar Besi Sudut 角铁
LC1230	90°	115mm	150 x 75mm	100mm	100mm
	45°	90mm	85 x 85mm	85mm	85mm
LW1400	90°	127mm	233 x 70mm	119mm	137mm
	45°	127mm	115 x 103mm	106mm	100mm
LW1401	90°	127mm	233 x 70mm	119mm	137mm
	45°	127mm	115 x 103mm	106mm	100mm
2416S	90°	115mm	230 x 80mm	120mm	150mm
	45°	115mm	110 x 110mm	110mm	110mm

JN1601 1.6mm (16Ga)

Nibbler
Pemotong Elektrik
电冲剪



- **2,200 SPM for faster and smooth cutting**
2,200 SPM untuk pemotongan cepat dan lancar
2200 SPM更快更顺畅地切割

Standard Equipment: Hex Wrench, Wrench, Punch, Die



411

Continuous Rating Input Input Kuasa Berterusan 额定输入功率	550W
Capacity Kapasiti 能力	Steel up to 400 N/mm ² : 1.6mm Steel up to 600 N/mm ² : 1.2mm Steel up to 800 N/mm ² : 0.8mm Aluminum up to 200 N/mm ² : 2.5mm
Min. Cutting Radius Radius Pemotongan Minimum 最小切割半径	Outside edge : 50mm (2") Inside edge : 45mm (1-3/4")
Strokes Per Minute (SPM) Kelajuan Strok 冲程速度	2,200
Overall Length Panjang Keseluruhan 总长度	261mm (10-1/4")
Net Weight Berat Bersih 净重	1.6kg (3.6lbs)
Power Supply Cord Kabel Wayar 电源线	2.0m (6.6ft)

JN3201 3.2mm (10Ga)

Nibbler
Pemotong Elektrik
电冲剪



- **Built-in thickness gauge for operator convenience**
Penyukat ketebalan terbina dalam memudahkan pengguna
内置厚度仪方便使用

Standard Equipment:
Punch, Die, Wrench 50, Hex Wrench, Washer



303

Continuous Rating Input Input Kuasa Berterusan 额定输入功率	710W
Capacity Kapasiti 能力	Steel up to 400 N/mm ² : 3.2mm Steel up to 600 N/mm ² : 2.5mm Steel up to 800 N/mm ² : 1.0mm Aluminum up to 200 N/mm ² : 3.5mm
Min. Cutting Radius Radius Pemotongan Minimum 最小切割半径	Outside edge : 128mm (5-1/16") Inside edge : 120mm (4-3/4")
Strokes Per Minute (SPM) Kelajuan Strok 冲程速度	1,300
Dimensions (L x W x H) Dimensi 体积	225x90x254mm (8-7/8"x1-1/2"x10")
Net Weight Berat Bersih 净重	3.4kg (7.4lbs)
Power Supply Cord Kabel Wayar 电源线	2.5m (8.2ft)

Cordless
Tepat Untuk Kejuruteraan

LED Flashlight
Lampu Suluh LED
LED 照明灯

Vacuum Cleaner
Pembersih Vakuum
吸尘器

Drilling / Fastening
Gergasi / Pasang
钻孔 / 紧固

Impact Drilling / Demolition
Gergasi / Romban
冲击钻孔 / 拆除

Cutting
Pemotong
切割

Grinding / Sanding
Pengkilan / Hala
打磨 / 砂磨

Sawing
Gergaji
锯切

Planing / Routing
Pengkilan / Tonggolan
刨平 / 压花

Others
Lain-lain
其他

Outdoor Power Equipment
Alatan Kuasa Luar
户外动力设备

Makita
makita

CUTTING (Metal)

JS1601 1.6mm (16Ga) 459 W

Straight Metal Shear
Pemotong Elektrik
电剪刀



- **Fast Cutting Action in Steel and Aluminum**
Pemotongan Cepat untuk Keluli dan Aluminium
快速切割钢和铝

Standard Equipment: Hex Wrench, Thickness Gauge



Continuous Rating Input Input Kuasa Berterusan 额定输入功率	380W
Capacity Kapasiti 能力	Steel up to 400N/mm ² : 1.6mm Steel up to 600N/mm ² : 1.2mm Steel up to 800N/mm ² : 0.8mm Aluminum up to 200N/mm ² : 2.5mm 250mm (9-7/8")
Min. Cutting Radius Radius Pemotongan Minimum 最小切割半径	
Strokes Per Minute (SPM) Kelajuan Strok 冲程速度	4,500
Dimensions (L x W x H) Dimensi 体积	320x70x78mm (12-5/8"x2-3/4"x3-1/16")
Net Weight Berat Bersih 净重	1.4kg (3.2lbs)
Power Supply Cord Kabel Wayar 电源线	2.5m (8.2ft)

JS1300 1.3mm 419 W

Straight Shear
Pemotong Elektrik
电剪刀



- **Shear head attachment rotates 360°**
Kepala pemotong boleh berputar 360°
剪切头附件可旋转360°

Standard Equipment: Hex Wrench



Continuous Rating Input Input Kuasa Berterusan 额定输入功率	570W
Capacity Kapasiti 能力	Steel up to 400N/mm ² : 1.3mm Steel up to 600N/mm ² : 1.0mm Steel up to 800N/mm ² : 0.5mm Aluminum up to 200N/mm ² : 2.5mm 0-2,500
Strokes Per Minute (SPM) Kelajuan Strok 冲程速度	0-2,500
Overall Length Panjang Keseluruhan 总长度	302mm (11-7/8")
Net Weight Berat Bersih 净重	1.8kg (3.9lbs)
Power Supply Cord Kabel Wayar 电源线	2.5m (8.2ft)

JS1602 1.6mm (16Ga) 459 W

Metal Shear
Pemotong Elektrik
电剪刀



- **Fast and efficient cutting**
Pemotongan cepat dan cekap
快速高效的切割

Standard Equipment: Hex Wrench, Shear Blade Set



Continuous Rating Input Input Kuasa Berterusan 额定输入功率	380W
Capacity Kapasiti 能力	Steel up to 400N/mm ² : 1.6mm Steel up to 600N/mm ² : 1.2mm Steel up to 800N/mm ² : 0.8mm Aluminum up to 200N/mm ² : 2.5mm 30mm (1-3/16")
Min. Cutting Radius Radius Pemotongan Minimum 最小切割半径	
Strokes Per Minute (SPM) Kelajuan Strok 冲程速度	4,000
Dimensions (L x W x H) Dimensi 体积	255x74x146mm (10"x2-15/16"x5-3/4")
Net Weight Berat Bersih 净重	1.6kg (3.4lbs)
Power Supply Cord Kabel Wayar 电源线	2.5m (8.2ft)

JS3201 3.2mm (10Ga) 303 W

Metal Shear
Pemotong Elektrik
电剪刀



- **Powerful 710W Motor**
Motor berkuasa 710W
强力710W马达

Standard Equipment: Shear Blade Set, Hex Wrench, Thickness Gauge



Continuous Rating Input Input Kuasa Berterusan 额定输入功率	710W
Capacity Kapasiti 能力	Steel up to 400N/mm ² : 3.2mm Steel up to 600N/mm ² : 2.5mm Steel up to 800N/mm ² : 1.5mm Aluminum up to 200N/mm ² : 4.0mm 50mm (2")
Min. Cutting Radius Radius Pemotongan Minimum 最小切割半径	
Strokes Per Minute (SPM) Kelajuan Strok 冲程速度	1,600
Dimensions (L x W x H) Dimensi 体积	213x90x239mm (8-3/8"x3-1/2"x9-3/8")
Net Weight Berat Bersih 净重	3.4kg (7.5lbs)
Power Supply Cord Kabel Wayar 电源线	2.5m (8.2ft)

CA5000X 118mm (4-5/8") 303 W

Aluminum Groove Cutter
Mesin Memotong Aluminium
铝板开槽切割机



- **Cutter blade for 135 degrees V shaped groove as an option**
Bilah pemotong alur 135° berbentuk V pemilihan
可选135° V形槽的锯片

Standard Equipment: Cutter Blade, Plate, Hex Wrench

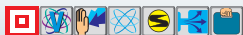

Continuous Rating Input Input Kuasa Berterusan 额定输入功率	1,300W
Blade Bilah 锯片	Type: Cutter blade/ TCT saw blade
Max Cutting Capacity w/ Cutter blade Kapasiti Pemotongan Maksimum 最大切割能力	w/ Guide rail: 11mm (7/16")
Max Cutting Capacity w/ TCT Saw blade Kapasiti Pemotongan Maksimum 最大切割能力	w/ Guide rail: 36mm (1-7/16") w/o Guide rail: 41mm (1-5/8")
No Load Speed (RPM) Kelajuan Tanpa Beban 回转数	2,200-6,400
Dimensions (L x W x H) Dimensi 体积	346x250x250mm (13-5/8"x9-7/8"x9-7/8")
Net Weight Berat Bersih 净重	4.7kg (10.4lbs)
Power Supply Cord Kabel Wayar 电源线	2.5m (8.2ft)

Cordless
Terdapat Model Berwayar

LED Flashlight
Lampat Cahaya LED
LED Model

Vacuum Cleaner
Pembersih Vakuum
Model

Drilling / Fastening
Drmil / Pasang
Model

Impact Drilling / Demolition
Drmil / Persekit
Model

Cutting
Pemotong
Model

Grinding / Sanding
Hmgl / Pasang
Model

Sawing
Drmil
Model

Planing / Routing
Pengaliran / Pasang
Model

Others
Lain-lain
Model

Outdoor Power Equipment
Alatan Kuasa Luar
Model



GRINDING SANDING

Pengisar | Pelicin 研削 | 研磨



9553HNG 100mm (4")

325

Angle Grinder Pengisar Sudut 角向磨光机



Slide Switch

Suis Gelangsar 滑动开关

- **Spiral bevel gears for smoother rotations**
Gear serong lingkaran untuk putaran yang licin
螺旋锥齿轮更平滑的旋转



Standard Equipment: Depressed Center Wheel (A-80852), Side Grip, Wheel Cover, Lock Nut Wrench



Continuous Rating Input Input Kuasa Berterusan 额定输入功率	710W
Wheel Diameter Diameter Roda 轮片直径	100mm (4")
No Load Speed (RPM) Kelajuan Tanpa Beban 回转数	11,000
Dimensions (L x W x H) Dimensi 体积	258x118x97mm (10-1/8"x4-5/8"x3-13/16")
Net Weight Berat Bersih 净重	1.5 - 1.8kg (3.2 - 4.1lbs)
Power Supply Cord Kabel Wayar 电源线	2.5m (8.2ft.)

9553HBG 100mm (4")

325

Angle Grinder Pengisar Sudut 角向磨光机



Toggle Switch

Suis Togol 后盖式开关

- **Compact design and lightweight**
Reka bentuk padat dan ringan
设计紧凑, 轻量



Standard Equipment: Depressed Center Wheel (A-80852), Wheel Cover, Lock Nut Wrench



Continuous Rating Input Input Kuasa Berterusan 额定输入功率	710W
Wheel Diameter Diameter Roda 轮片直径	100mm (4")
No Load Speed (RPM) Kelajuan Tanpa Beban 回转数	11,000
Dimensions (L x W x H) Dimensi 体积	258x118x97mm (10-1/8"x4-5/8"x3-13/16")
Net Weight Berat Bersih 净重	1.5 - 1.9kg (3.3 - 4.1lbs)
Power Supply Cord Kabel Wayar 电源线	2.5m (8.2ft.)

GA4030R 100mm (4")

459

Angle Grinder Pengisar Sudut 角向磨光机



Slide Switch

Suis Gelangsar 滑动开关

- **Machined bevel gears provide up to 2x longer service life**
Gear bevel machined memanjangkan hayat penggunaan 2x lebih lama
加工锥齿轮延长了长达 2x 的使用寿命



Standard Equipment: Depressed Center Wheel (A-80852), Side Grip, Wheel Cover, Lock Nut Wrench



Continuous Rating Input Input Kuasa Berterusan 额定输入功率	720W
Wheel Diameter Diameter Roda 轮片直径	100mm (4")
No Load Speed (RPM) Kelajuan Tanpa Beban 回转数	11,000
Dimensions (L x W x H) Dimensi 体积	266x118x102mm (10-1/2"x4-5/8"x4")
Net Weight Berat Bersih 净重	1.72 - 2.01kg (3.79 - 4.43lbs)
Power Supply Cord Kabel Wayar 电源线	2.5m (8.2ft)

Cordless
Tanpa Ford 无绳式

LED Flashlight
Lampu Suis LED
LED 照明灯

Vacuum Cleaner
Penjimat Vakuum
吸尘器

Drilling / Fastening
Gergaji / Pengisar
钻式 / 磨式

Impact Drilling / Demolition
Gergaji / Pengisar
冲击钻式 / 破拆式

Cutting / Finishing
Pengisar / Pengisar
切割 / 打磨

Grinding / Sanding
Pengisar / Pengisar
磨削 / 研磨

Sanding / Grinding
Pengisar / Pengisar
打磨 / 磨削

Planing / Routing
Pengisar / Pengisar
刨削 / 铣削

Others
Lain-lain
其他

Outdoor Power Equipment
Alatan Kuasa Luar
户外动力设备

Makita
1 INT

GRINDING | SANDING

GA4030 100mm (4")

459 

Angle Grinder Pengisar Sudut 角向磨光机



Slide Switch

Suis Gelangsar 滑动开关

- **All ball bearing construction for durability and longer tool life**
Struktur galas bola untuk mempanjangkan hayat alat
滚珠轴承结构延长工具寿命



Standard Equipment: Depressed Center Wheel (A-80852), Side Grip, Wheel Cover, Lock Nut Wrench



Continuous Rating Input Input Kuasa Berterusan 额定输入功率	720W
Wheel Diameter Diameter Roda 轮片直径	100mm (4")
No Load Speed (RPM) Kelajuan Tanpa Beban 回转数	11,000
Dimensions (L x W x H) Dimensi 体积	266x117x95mm (10-1/2"x4-5/8"x3-3/4")
Net Weight Berat Bersih 淨重	1.73 - 2.02kg (3.81 - 4.45lbs)
Power Supply Cord Kabel Wayar 电源线	2.5m (8.2ft)

GA4031 100mm (4")

459 

Angle Grinder Pengisar Sudut 角向磨光机



Toggle Switch

Suis Togol 后置式开关

- **Toggle switch for easy operation**
Suis togol untuk operasi lebih mudah
后置式开关方便操作



Standard Equipment: Depressed Center Wheel (A-80852), Wheel Cover, Lock Nut Wrench



Continuous Rating Input Input Kuasa Berterusan 额定输入功率	720W
Wheel Diameter Diameter Roda 轮片直径	100mm (4")
No Load Speed (RPM) Kelajuan Tanpa Beban 回转数	11,000
Dimensions (L x W x H) Dimensi 体积	259x118x104mm (10-1/4"x4-5/8"x4-1/8")
Net Weight Berat Bersih 淨重	1.71 - 2.00kg (3.77 - 4.41lbs)
Power Supply Cord Kabel Wayar 电源线	2.5m (8.2ft)

GA4034 100mm (4")

459 

Angle Grinder Pengisar Sudut 角向磨光机



Paddle Switch

Suis Pemicu 扳机开关

- **Machined bevel gears provide up to 2x longer service life**
Gear bevel machined mempanjangkan hayat penggunaan 2x lebih lama
加工锥齿轮延长了长达 2x 的使用寿命



Standard Equipment: Depressed Center Wheel (A-80852), Side Grip, Wheel Cover, Lock Nut Wrench



Continuous Rating Input Input Kuasa Berterusan 额定输入功率	720W
Wheel Diameter Diameter Roda 轮片直径	100mm (4")
No Load Speed (RPM) Kelajuan Tanpa Beban 回转数	11,000
Dimensions (L x W x H) Dimensi 体积	265x118x95mm (10-3/8"x4-5/8"x3-3/4")
Net Weight Berat Bersih 淨重	1.77 - 2.06kg (3.90 - 4.54lbs)
Power Supply Cord Kabel Wayar 电源线	2.5m (8.2ft)

9556HNG / HN / NB 100mm (4")

325 

Angle Grinder Pengisar Sudut 角向磨光机



Slide Switch

Suis Gelangsar 滑动开关

- **Powerful 840W motor**
Motor berkuasa 840W
强力840W马达



Standard Equipment: Depressed Center Wheel (A-80852), Side Grip, Wheel Cover, Lock Nut Wrench



Continuous Rating Input Input Kuasa Berterusan 额定输入功率	840W
Wheel Diameter Diameter Roda 轮片直径	100mm (4")
No Load Speed (RPM) Kelajuan Tanpa Beban 回转数	11,000
Dimensions (L x W x H) Dimensi 体积	271x118x97mm (10-5/8"x4-5/8"x3-13/16")
Net Weight Berat Bersih 淨重	1.6 - 2.0kg (3.6 - 4.4lbs)
Power Supply Cord Kabel Wayar 电源线	2.5m (8.2ft.)

9556HPG / PB 100mm (4")

325 

Angle Grinder Pengisar Sudut 角向磨光机



Paddle Switch

Suis Pemicu 扳机开关

- **Powerful 840W motor**
Motor berkuasa 840W
强力840W马达



Standard Equipment: Depressed Center Wheel (A-80852), Side Grip, Wheel Cover, Lock Nut Wrench



Continuous Rating Input Input Kuasa Berterusan 额定输入功率	840W
Wheel Diameter Diameter Roda 轮片直径	100mm (4")
No Load Speed (RPM) Kelajuan Tanpa Beban 回转数	11,000
Dimensions (L x W x H) Dimensi 体积	273x118x97mm (10-3/4"x4-5/8"x3-13/16")
Net Weight Berat Bersih 淨重	1.6 - 2.0kg (3.6 - 4.5lbs)
Power Supply Cord Kabel Wayar 电源线	2.5m (8.2ft.)

GRINDING | SANDING

GA4040 100mm (4") 325 mm

Angle Grinder
Pengisar Sudut
角向磨光机



Slide Switch
Suis Gelangsar 滑动开关

- **Spiral bevel gears for smoother rotations and a more efficient transfer of energy**
gear serong lingkaran untuk pemindahan tenaga yang lebih cekap
螺旋锥齿轮高效输送能源



Standard Equipment: Depressed Center Wheel (A-80852), Side Grip, Wheel Cover, Lock Nut Wrench



Continuous Rating Input Input Kuasa Berterusan 额定输入功率	1,100W
Wheel Diameter Diameter Roda 轮片直径	100mm (4")
No Load Speed (RPM) Kelajuan Tanpa Beban 回转数	11,000
Dimensions (L x W x H) Dimensi 体积	303x117x111mm (11-7/8"x4-5/8"x4-3/8")
Net Weight Berat Bersih 净重	2.2 - 2.5kg (4.9 - 5.6lbs)
Power Supply Cord Kabel Wayar 电源线	2.5m (8.2ft)

GA4041C 100mm (4") 318 mm

Angle Grinder
Pengisar Sudut
角向磨光机



Slide Switch
Suis Gelangsar 滑动开关

- **Super Joint System II developed for effective vibration absorption**
SJS generasi kedua berkesan untuk menyerap getaran
第二代 SJS 有效抑止震动



Standard Equipment: Depressed Center Wheel (A-80852), Side Grip, Wheel Cover, Lock Nut Wrench



Continuous Rating Input Input Kuasa Berterusan 额定输入功率	1,400W
Wheel Diameter Diameter Roda 轮片直径	100mm (4")
No Load Speed (RPM) Kelajuan Tanpa Beban 回转数	2,800-11,000
Dimensions (L x W x H) Dimensi 体积	325x117x117mm (12-3/4"x4-5/8"x4-5/8")
Net Weight Berat Bersih 净重	2.5 - 2.8kg (5.6 - 6.2lbs)
Power Supply Cord Kabel Wayar 电源线	2.5m (8.2ft)

GA4040C 100mm (4") 318 mm

Angle Grinder
Pengisar Sudut
角向磨光机



Slide Switch
Suis Gelangsar 滑动开关

- **Super Joint System II developed for effective vibration absorption**
SJS generasi kedua berkesan untuk menyerap getaran
第二代 SJS 有效抑止震动



Standard Equipment: Depressed Center Wheel (A-80852), Side Grip, Wheel Cover, Lock Nut Wrench



Continuous Rating Input Input Kuasa Berterusan 额定输入功率	1,400W
Wheel Diameter Diameter Roda 轮片直径	100mm (4")
No Load Speed (RPM) Kelajuan Tanpa Beban 回转数	2,800-11,000
Dimensions (L x W x H) Dimensi 体积	303x117x111mm (11-7/8"x4-5/8"x4-3/8")
Net Weight Berat Bersih 净重	2.3 - 2.6kg (5.1 - 5.7lbs)
Power Supply Cord Kabel Wayar 电源线	2.5m (8.2ft)

9563C 100mm (4") 318 mm

Angle Grinder
Pengisar Sudut
角向磨光机



Slide Switch
Suis Gelangsar 滑动开关

- **High power anti-dust motor**
Motor tahan debu tinggi
大功率防尘马达



Standard Equipment: Depressed Center Wheel (D-18443), Side Grip, Wheel Cover, Lock Nut Wrench



Continuous Rating Input Input Kuasa Berterusan 额定输入功率	1,400W
Wheel Diameter Diameter Roda 轮片直径	100mm (4")
No Load Speed (RPM) Kelajuan Tanpa Beban 回转数	12,000
Overall Length Dimensi 体积	299mm (11-3/4")
Net Weight Berat Bersih 净重	2.1kg (4.6lbs)
Power Supply Cord Kabel Wayar 电源线	2.5m (8.2ft)



Cordless
Tanpa Kabel 无线式

LED Flashlight
Lampu Suis LED
LED照明灯

Vacuum Cleaner
Penjimat Vakuum
吸尘器

Drilling / Fastening
Gergaji / Pengikat
钻床 / 夹具

Impact Drilling / Demolition
Gergaji / Pengikat
冲击钻 / 破拆工具

Cutting
Pemotong
切割机

Grinding / Sanding
Pengisar / Poles
打磨 / 研磨

Sawing
Gergaji
锯切

Planing / Routing
Penghalus / Tengam
刨床 / 铣床

Others
Lain-lain
其他

Outdoor Power Equipment
Alatan Kerja Luar
户外动力工具

Makita
1 INT

GRINDING | SANDING

GA4530 115mm (4-1/2")

459 W

Angle Grinder Pengisar Sudut 角向磨光机



Slide Switch

Suis Gelangsar 滑动开关

- **Small diameter barrel grip for added comfort**
Genggaman barrel diameter kecil meningkatkan keselesaan
小直径桶形手柄，增加手握舒适度



Standard Equipment: Depressed Center Wheel (A-80640), Side Grip, Wheel Cover, Lock Nut Wrench



Continuous Rating Input Input Kuasa Berterusan 额定输入功率	720W
Wheel Diameter Diameter Roda 轮片直径	115mm (4-1/2")
No Load Speed (RPM) Kelajuan Tanpa Beban 回转数	11,000
Dimensions (L x W x H) Dimensi 体积	266x128x103mm (10-1/2"x5"x4-1/16")
Net Weight Berat Bersih 净重	1.89 - 2.23kg (4.17 - 4.91lbs)
Power Supply Cord Kabel Wayar 电源线	2.5m (8.2ft)

GA4530R 115mm (4-1/2")

459 W

Angle Grinder Pengisar Sudut 角向磨光机



Slide Switch

Suis Gelangsar 滑动开关

- **Anti-restart function prevents accidental start-up**
Fungsi anti-restart menghalang penghidupan yang tidak disengajakan
防重启功能可防止意外启动



Standard Equipment: Depressed Center Wheel (A-80640), Side Grip, Wheel Cover, Lock Nut Wrench



Continuous Rating Input Input Kuasa Berterusan 额定输入功率	720W
Wheel Diameter Diameter Roda 轮片直径	115mm (4-1/2")
No Load Speed (RPM) Kelajuan Tanpa Beban 回转数	11,000
Dimensions (L x W x H) Dimensi 体积	266x130x108mm (10-1/2"x5-1/2"x4-1/4")
Net Weight Berat Bersih 净重	1.88 - 2.22kg (4.14 - 4.89lbs)
Power Supply Cord Kabel Wayar 电源线	2.5m (8.2ft)

9557HNG / NBG 115mm (4-1/2")

325 W

Angle Grinder Pengisar Sudut 角向磨光机



Slide Switch

Suis Gelangsar 滑动开关

- **Powerful 840W motor**
Motor berkuasa 840W
强力840W马达



Standard Equipment: Depressed Center Wheel, Side Grip, Wheel Cover, Lock Nut Wrench



Continuous Rating Input Input Kuasa Berterusan 额定输入功率	840W
Wheel Diameter Diameter Roda 轮片直径	115mm (4-1/2")
No Load Speed (RPM) Kelajuan Tanpa Beban 回转数	11,000
Dimensions (L x W x H) Dimensi 体积	271x129x106mm (10-5/8"x5-1/8"x4-3/16")
Net Weight Berat Bersih 净重	1.7 - 2.2kg (3.8 - 4.8lbs)
Power Supply Cord Kabel Wayar 电源线	2.5m (8.2ft)

9557HPG 115mm (4-1/2")

325 W

Angle Grinder Pengisar Sudut 角向磨光机



Paddle Switch

Suis Pemacu 扳机开关

- **Large Flush-Mount Paddle Switch for Comfortable Operation**
Suis Flush-mount mudah digunakan
大型平装式扳钮开关易于操作



Standard Equipment: Depressed Center Wheel, Side Grip, Wheel Cover, Lock Nut Wrench



Continuous Rating Input Input Kuasa Berterusan 额定输入功率	840W
Wheel Diameter Diameter Roda 轮片直径	115mm (4-1/2")
No Load Speed (RPM) Kelajuan Tanpa Beban 回转数	11,000
Dimensions (L x W x H) Dimensi 体积	273x129x106mm (10-3/4"x5-1/8"x4-3/16")
Net Weight Berat Bersih 净重	1.8 - 2.2kg (3.9 - 4.8lbs)
Power Supply Cord Kabel Wayar 电源线	2.5m (8.2ft)

GA4540R 115mm (4-1/2")

325 W

Angle Grinder Pengisar Sudut 角向磨光机



Slide Switch

Suis Gelangsar 滑动开关

- **Super Joint System II developed for effective vibration absorption**
SJS generasi kedua berkesan untuk menyerap getaran
第二代 SJS 有效抑制震动



Standard Equipment: Depressed Center Wheel (A-80640), Side Grip, Wheel Cover, Lock Nut Wrench



Continuous Rating Input Input Kuasa Berterusan 额定输入功率	1,100W
Wheel Diameter Diameter Roda 轮片直径	115mm (4-1/2")
No Load Speed (RPM) Kelajuan Tanpa Beban 回转数	11,000
Dimensions (L x W x H) Dimensi 体积	303x130x116mm (11-7/8"x5-1/8"x4-9/16")
Net Weight Berat Bersih 净重	2.4 - 2.8kg (5.4 - 6.1lbs)
Power Supply Cord Kabel Wayar 电源线	2.5m (8.2ft)

GRINDING | SANDING

GA4540 115mm (4-1/2")

325 W

Angle Grinder Pengisar Sudut 角向磨光机



Slide Switch

Suis Gelangsar 滑动开关

- Super Joint System II developed for effective vibration absorption
SJS generasi kedua berkesan untuk menyerap getaran
第二代 SJS 有效抑止震动



Standard Equipment: Depressed Center Wheel (A-80640), Side Grip, Wheel Cover, Lock Nut Wrench



Continuous Rating Input Input Kuasa Berterusan 额定输入功率	1,100W
Wheel Diameter Diameter Roda 轮片直径	115mm (4-1/2")
No Load Speed (RPM) Kelajuan Tanpa Beban 回转数	11,000
Dimensions (L x W x H) Dimensi 体积	303x130x116mm (11-7/8"x5-1/8"x4-9/16")
Net Weight Berat Bersih 净重	2.3 - 2.7kg (5.2 - 6.0lbs)
Power Supply Cord Kabel Wayar 电源线	2.5m (8.2ft)

GA4541C 115mm (4-1/2")

318 W

Angle Grinder Pengisar Sudut 角向磨光机



Slide Switch

Suis Gelangsar 滑动开关

- Super Joint System II developed for effective vibration absorption
SJS generasi kedua berkesan untuk menyerap getaran
第二代 SJS 有效抑止震动



Standard Equipment: Depressed Center Wheel (D-18459), Side Grip, Wheel Cover, Lock Nut Wrench



Continuous Rating Input Input Kuasa Berterusan 额定输入功率	1,400W
Wheel Diameter Diameter Roda 轮片直径	115mm (4-1/2")
No Load Speed (RPM) Kelajuan Tanpa Beban 回转数	2,800-11,000
Dimensions (L x W x H) Dimensi 体积	325x130x121mm (12-3/4"x5-1/8"x4-3/4")
Net Weight Berat Bersih 净重	2.7 - 3.0kg (5.9 - 6.7lbs)
Power Supply Cord Kabel Wayar 电源线	2.5m (8.2ft)



GA5030 125mm (5")

459 W

Angle Grinder Pengisar Sudut 角向磨光机



Slide Switch

Suis Gelangsar 滑动开关

- Machined bevel gears provide up to 2x longer service life
Gear bevel machined memajukan hayat penggunaan 2x lebih lama
加工锥齿轮延长了长达 2x 的使用寿命



Standard Equipment: Depressed Center Wheel (A-80656), Side Grip, Wheel Cover, Lock Nut Wrench



Continuous Rating Input Input Kuasa Berterusan 额定输入功率	720W
Wheel Diameter Diameter Roda 轮片直径	125mm (5")
No Load Speed (RPM) Kelajuan Tanpa Beban 回转数	11,000
Dimensions (L x W x H) Dimensi 体积	266x138x103mm (10-1/2"x5-7/16"x4-1/16")
Net Weight Berat Bersih 净重	1.92 - 3.07kg (4.23 - 6.77lbs)
Power Supply Cord Kabel Wayar 电源线	2.5m (8.2ft)

GA5030R 125mm (5")

459 W

Angle Grinder Pengisar Sudut 角向磨光机



Slide Switch

Suis Gelangsar 滑动开关

- Anti-restart function prevents accidental start-up
Fungsi anti-restart menghalang penghidupan yang tidak disengajakan
防重启功能可防止意外启动



Standard Equipment: Depressed Center Wheel (A-80656), Side Grip, Wheel Cover, Lock Nut Wrench



Continuous Rating Input Input Kuasa Berterusan 额定输入功率	720W
Wheel Diameter Diameter Roda 轮片直径	125mm (5")
No Load Speed (RPM) Kelajuan Tanpa Beban 回转数	11,000
Dimensions (L x W x H) Dimensi 体积	266x140x108mm (10-1/2"x5-1/2"x4-1/4")
Net Weight Berat Bersih 净重	1.91 - 3.06kg (4.21 - 6.75lbs)
Power Supply Cord Kabel Wayar 电源线	2.5m (8.2ft)

Cordless
Tanpa Hood 无绳式LED Flashlight
Lampu Suisah LED
LED 照明灯Vacuum Cleaner
Pembersih Vakuum
吸尘器Drilling / Fastening
Gergaji / Pengikat
钻 / 紧固Impact Drilling / Demolition
Gergaji / Perseki
冲击钻 / 拆除Cutting
Pemotong
切割Grinding / Sanding
Pengisar / Pasir
磨 / 砂Sawing
Gergaji
锯切Planing / Routing
Penghalus / Tengam
刨 / 铣Others
Lain-lain
其他Outdoor Power Equipment
Alatan Kuasa Luar
户外动力设备Makita
MAKITA

GRINDING | SANDING

GA5034 125mm (5")

459 

Angle Grinder Pengisar Sudut 角向磨光机



Paddle Switch

Suis Pemicu 扳机开关

- **Small Diameter Barrel Grip**
Genggamang Barel Diameter Kecil
小直径握把



Standard Equipment: Depressed Center Wheel (A-80656), Side Grip, Wheel Cover, Lock Nut Wrench



Continuous Rating Input Input Kuasa Berterusan 额定输入功率	720W
Wheel Diameter Diameter Roda 轮片直径	125mm (5")
No Load Speed (RPM) Kelajuan Tanpa Beban 回转数	11,000
Dimensions (L x W x H) Dimensi 体积	265x139x103mm (10-3/8"x5-1/2"x4-1/16")
Net Weight Berat Bersih 净重	2.00 - 3.15kg (4.41 - 6.94lbs)
Power Supply Cord Kabel Wayar 电源线	2.5m (8.2ft)

9558HNG / NBG 125mm (5")

325 

Angle Grinder Pengisar Sudut 角向磨光机



Slide Switch

Suis Gelangsar 滑动开关

- **Slide switch with lock-on for continuous use**
Suis gelangсар dengan fungsi mengunci untuk kegunaan berterusan
备有锁定功能的滑动按钮可连续无间断的使用



Standard Equipment: Depressed Center Wheel, Side Grip, Wheel Cover, Lock Nut Wrench



Continuous Rating Input Input Kuasa Berterusan 额定输入功率	840W
Wheel Diameter Diameter Roda 轮片直径	125mm (5")
No Load Speed (RPM) Kelajuan Tanpa Beban 回转数	11,000
Dimensions (L x W x H) Dimensi 体积	271x139x106mm (10-5/8"x5-1/2"x4-3/16")
Net Weight Berat Bersih 净重	1.7 - 3.2kg (3.8 - 6.6lbs)
Power Supply Cord Kabel Wayar 电源线	2.5m (8.2ft)

9558HPG 125mm (5")

325 

Angle Grinder Pengisar Sudut 角向磨光机



Paddle Switch

Suis Pemicu 扳机开关

- **Large Flush-Mount Paddle Switch for Comfortable Operation**
Suis Flush-mount mudah digunakan
大型平装式扳机开关易于操作



Standard Equipment: Depressed Center Wheel, Side Grip, Wheel Cover, Lock Nut Wrench



Continuous Rating Input Input Kuasa Berterusan 额定输入功率	840W
Wheel Diameter Diameter Roda 轮片直径	125mm (5")
No Load Speed (RPM) Kelajuan Tanpa Beban 回转数	11,000
Dimensions (L x W x H) Dimensi 体积	273x139x106mm (10-3/4"x5-1/2"x4-3/16")
Net Weight Berat Bersih 净重	1.8 - 3.0kg (3.9 - 6.7lbs)
Power Supply Cord Kabel Wayar 电源线	2.5m (8.2ft)

GA5020 125mm (5")

303 

Angle Grinder Pengisar Sudut 角向磨光机



Trigger Switch

Suis Pemicu 扳机开关

- **SJS Mechanical Clutch System Helps Prevent Motor and Gear Damage**
Sistem SJS mencegah kerosakan pada motor dan gear
SJS 系统有助于防止马达和齿轮损坏



Standard Equipment: Depressed Center Wheel (A-80656), Side Grip, Wheel Cover, Lock Nut Wrench



Continuous Rating Input Input Kuasa Berterusan 额定输入功率	1,050W
Wheel Diameter Diameter Roda 轮片直径	125mm (5")
No Load Speed (RPM) Kelajuan Tanpa Beban 回转数	12,000
Dimensions (L x W x H) Dimensi 体积	356x139x120mm (14"x5-1/2"x4-3/4")
Net Weight Berat Bersih 净重	2.7 - 3.9kg (6.0 - 8.6lbs)
Power Supply Cord Kabel Wayar 电源线	2.5m (8.2ft)

GA5010 125mm (5")

303 

Angle Grinder Pengisar Sudut 角向磨光机



Trigger Switch

Suis Pemicu 扳机开关

- **Powerful 1,050W motor**
Motor berkuasa 1,050W
强力1,050W马达



Standard Equipment: Depressed Center Wheel (A-80656), Side Grip, Wheel Cover, Lock Nut Wrench



Continuous Rating Input Input Kuasa Berterusan 额定输入功率	1,050W
Wheel Diameter Diameter Roda 轮片直径	125mm (5")
No Load Speed (RPM) Kelajuan Tanpa Beban 回转数	12,000
Dimensions (L x W x H) Dimensi 体积	356x139x112mm (14"x5-1/2"x4-3/8")
Net Weight Berat Bersih 净重	2.6 - 3.8kg (5.8 - 8.4lbs)
Power Supply Cord Kabel Wayar 电源线	2.5m (8.2ft)

GRINDING | SANDING

GA5040 125mm (5")

325

Angle Grinder Pengisar Sudut 角向磨光机



Slide Switch

Suis Gelangsar 滑动开关



- **Connectable to Makita vacuum cleaner with optional dust collecting wheel guard**
Boleh bersambung dengan pembersih vakum Makita dengan alat pilihan pengumpul debu
可选附件轮状集尘罩以连接 Makita 吸尘器

Standard Equipment: Depressed Center Wheel, Side Grip, Wheel Cover, Lock Nut Wrench



Continuous Rating Input Input Kuasa Berterusan 额定输入功率	1,100W
Wheel Diameter Diameter Roda 轮片直径	125mm (5")
No Load Speed (RPM) Kelajuan Tanpa Beban 回转数	11,000
Dimensions (L x W x H) Dimensi 体积	303x140x116mm (11-7/8"x5-1/2"x4-9/16")
Net Weight Berat Bersih 净重	2.4 - 3.5kg (5.2 - 7.8lbs)
Power Supply Cord Kabel Wayar 电源线	2.5m (8.2ft)

GA5041C 125mm (5")

318

Angle Grinder Pengisar Sudut 角向磨光机



Slide Switch

Suis Gelangsar 滑动开关



- **Super Joint System II developed for effective vibration absorption**
SJS generasi kedua berkesan untuk menyerap getaran
第二代 SJS 有效抑止震动

Standard Equipment: Depressed Center Wheel, Side Grip, Wheel Cover, Lock Nut Wrench



Continuous Rating Input Input Kuasa Berterusan 额定输入功率	1,400W
Wheel Diameter Diameter Roda 轮片直径	125mm (5")
No Load Speed (RPM) Kelajuan Tanpa Beban 回转数	2,800-11,000
Dimensions (L x W x H) Dimensi 体积	325x140x121mm (12-3/4"x5-1/2"x4-3/4")
Net Weight Berat Bersih 净重	2.7 - 3.8kg (5.9 - 8.4lbs)
Power Supply Cord Kabel Wayar 电源线	2.5m (8.2ft)

9565CR / PC 125mm (5")

318

Angle Grinder Pengisar Sudut 角向磨光机



Slide Switch

Suis Gelangsar 滑动开关



- **SJS Mechanical Clutch System Helps Prevent Motor and Gear Damage**
Sistem SJS mencegah kerosakan pada motor dan gear
SJS 系统有助于防止马达和齿轮损坏

Standard Equipment:
9565CR: Depressed Center Wheel (B-56390), Side Grip, Wheel Cover, Lock Nut Wrench
9565PC: Side Grip, Wheel Cover, Lock Nut Wrench



Continuous Rating Input Input Kuasa Berterusan 额定输入功率	1,400W
Wheel Diameter Diameter Roda 轮片直径	125mm (5")
No Load Speed (RPM) Kelajuan Tanpa Beban 回转数	12,000
Dimensions (L x W x H) Dimensi 体积	299x139x103mm 9565CR (11-3/4"x5-1/2"x4-1/16") 307x139x103mm 9565PC (12-1/8"x5-1/2"x4")
Net Weight Berat Bersih 净重	2.4 - 3.5kg (5.2 - 7.7lbs)
Power Supply Cord Kabel Wayar 电源线	2.5m (8.2ft)



Recommended Accessories
Grinding Wheel for Heavy Industries



GA6010 150mm (6")

303

Angle Grinder Pengisar Sudut 角向磨光机



Trigger Switch

Suis Pemacu 扳机开关



- **Powerful 1,050W motor**
Motor berkuasa 1,050W
强力1,050W马达

Standard Equipment: Depressed Center Wheel (A-80846), Side Grip, Wheel Cover, Lock Nut Wrench



Continuous Rating Input Input Kuasa Berterusan 额定输入功率	1,050W
Wheel Diameter Diameter Roda 轮片直径	150mm (6")
No Load Speed (RPM) Kelajuan Tanpa Beban 回转数	10,000
Dimensions (L x W x H) Dimensi 体积	356x169x112mm (14"x6-5/8"x4-3/8")
Net Weight Berat Bersih 净重	2.7 - 3.1kg (5.9 - 6.9lbs)
Power Supply Cord Kabel Wayar 电源线	2.5m (8.2ft)

Cordless
Tanpa Kabel 无线LED Flashlight
Lampu Suis LED
LED照明灯Vacuum Cleaner
Pembersih Vakum
吸尘器Drilling / Fastening
Gergaji / Pengikat
钻床 / 夹具Impact Drilling / Demolition
Gergaji / Pemusnah
冲击钻 / 破拆工具Cutting
Pemotong
切割Grinding / Sanding
Pengisar / Peshih
磨削 / 砂磨Sanding
Gergaji
磨削Planing / Routing
Penghalus / Tenggam
刨削 / 雕刻Others
Lain-lain
其他Outdoor Power Equipment
Alatan Kuasa Luar
户外动力设备Makita
19157

GRINDING | SANDING

Cordless
Terdapat Model Tanpa Kabel

LED Flashlight
Lampu Senter LED
LED MANDIRI

Vacuum Cleaner
Pembersih Vakuum
MILWAU

Drilling / Fastening
Gergaji / Pengikat
MILWAU

Impact Drilling / Demolition
Gergaji / Pemecah
MILWAU

Cutting
Pemotong

Grinding / Sanding
Pengisar / Pasir
MILWAU

Sawing
Gergaji

Planing / Routing
Pengipatan / Trogram
MILWAU

Others
Lain-lain
MILWAU

Outdoor Power Equipment
Alat-alat Tenaga Luar
MILWAU

Makita
MILWAU

GA6040 150mm (6")

325 W

Angle Grinder
Pengisar Sudut
角向磨光机



Slide Switch
Suis Gelangsar 滑动开关

- **Super Joint System II developed for effective vibration absorption**
SJS generasi kedua berkesan untuk menyerap getaran
第二代 SJS 有效防止震动



Standard Equipment: Depressed Center Wheel (A-80846), Side Grip, Wheel Cover, Lock Nut Wrench



Continuous Rating Input Input Kuasa Berterusan 额定输入功率	1,100W
Wheel Diameter Diameter Roda 轮片直径	150mm (6")
No Load Speed (RPM) Kelajuan Tanpa Beban 回转速数	9,000
Dimensions (L x W x H) Dimensi 体积	303x171x116mm (11-7/8"x6-3/4"x4-9/16")
Net Weight Berat Bersih 淨重	2.4 - 2.8kg (5.3 - 6.2lbs)
Power Supply Cord Kabel Wayar 电源线	2.5m (8.2ft)

GA6020C 150mm (6")

253 W

Angle Grinder
Pengisar Sudut
角向磨光机



Trigger Switch
Suis Pemicu 扳机开关

- **Electric current limiter protects motor from overload**
Pembatasan arus elektrik melindungi motor dari kelebihan beban
电流限制器保护马达免超负荷



Standard Equipment: Depressed Center Wheel (A-80846), Side Grip, Wheel Cover, Lock Nut Wrench



Continuous Rating Input Input Kuasa Berterusan 额定输入功率	1,450W
Wheel Diameter Diameter Roda 轮片直径	150mm (6")
No Load Speed (RPM) Kelajuan Tanpa Beban 回转速数	9,000
Dimensions (L x W x H) Dimensi 体积	390x169x120mm (15-3/8"x6-5/8"x4-3/4")
Net Weight Berat Bersih 淨重	3.0 - 3.5kg (6.7 - 7.6lbs)
Power Supply Cord Kabel Wayar 电源线	2.5m (8.2ft)



GA7050 180mm (7")

204 W

Angle Grinder
Pengisar Sudut
角向磨光机



Trigger Switch
Suis Pemicu 扳机开关

- **Most compact in its class**
Paling padat dalam kelasnya
在同类中最紧凑



Standard Equipment: Side Grip, Wheel Cover, Lock Nut Wrench



Continuous Rating Input Input Kuasa Berterusan 额定输入功率	2,000W
Wheel Diameter Diameter Roda 轮片直径	180mm (7")
No Load Speed (RPM) Kelajuan Tanpa Beban 回转速数	8,500
Dimensions (L x W x H) Dimensi 体积	432x200x132mm (17"x7-7/8"x5-3/16")
Net Weight Berat Bersih 淨重	3.98 - 5.00kg (8.8 - 11.0lbs)
Power Supply Cord Kabel Wayar 电源线	2.5m (8.2ft)

GA7063R 180mm (7")

218 W

Angle Grinder
Pengisar Sudut
角向磨光机

Trigger Switch
Suis Pemicu 扳机开关

- **D-Handle protects operator's hand from materials**
Pemegang D melindungi tangan pengguna dari bahan
D型把手保护使用者的手远离物料



Standard Equipment: Side Grip, Wheel Cover, Lock Nut Wrench



Continuous rating input Panjang Strok 冲程长度	2,200W
Wheel Diameter Kelajuan Strok 冲程速度	180mm (7")
No Load Speed (RPM) Kapasiti 能力	8,500
Dimensions (L x W x H) Dimensi 体积	450x200x145mm (17-3/4"x7-7/8"x5-3/4")
Net weight Berat Bersih 淨重	5.70 - 6.21kg (12.6 - 13.7lbs)
Power supply cord	2.5m (8.2ft.)

GRINDING | SANDING

GA7062 180mm (7")

218

Angle Grinder Pengisar Sudut 角向磨光机

- Developed for heavy duty applications such as **foundry grinding**
Sesuai untuk aplikasi tugas berat
适合重型应用，如铸造磨削加工

Standard Equipment: Side Grip, Wheel Cover, Lock Nut Wrench



Trigger Switch Suis Pemicu 扳机开关



Continuous Rating Input Input Kuasa Berterusan 额定输入功率	2,200W
Wheel Diameter Diameter Roda 轮片直径	180mm (7")
No Load Speed (RPM) Kelajuan Tanpa Beban 回转数	8,500
Dimensions (L x W x H) Dimensi 体积	450x200x144mm (17-3/4"x7-7/8"x5-5/8")
Net Weight Berat Bersih 净重	5.51 - 6.02kg (12.2 - 13.3lbs)
Power Supply Cord Kabel Wayar 电源线	2.5m (8.2ft.)

GA7061R 180mm (7")

218

Angle Grinder Pengisar Sudut 角向磨光机



- Developed for heavy duty applications such as **foundry grinding**
Ringan untuk mengurangkan keletihan, meningkatkan produksi dengan berkesan
轻量不易引起疲劳，有效的增加工作量

Standard Equipment: Side Grip, Wheel Cover, Lock Nut Wrench



Trigger Switch Suis Pemicu 扳机开关



Continuous Rating Input Input Kuasa Berterusan 额定输入功率	2,200W
Wheel Diameter Diameter Roda 轮片直径	180mm (7")
No Load Speed (RPM) Kelajuan Tanpa Beban 回转数	8,500
Dimensions (L x W x H) Dimensi 体积	450x200x145mm (17-3/4"x7-7/8"x5-3/4")
Net Weight Berat Bersih 净重	5.57 - 6.08kg (12.3 - 13.4lbs)
Power Supply Cord Kabel Wayar 电源线	2.5m (8.2ft)

GA7060R 180mm (7")

218

Angle Grinder Pengisar Sudut 角向磨光机



- Developed for heavy duty applications such as **foundry grinding**
Sesuai untuk aplikasi tugas berat
适合重型应用，如铸造磨削加工

Standard Equipment: Side Grip, Wheel Cover, Lock Nut Wrench



Trigger Switch Suis Pemicu 扳机开关



Continuous Rating Input Input Kuasa Berterusan 额定输入功率	2,200W
Wheel Diameter Diameter Roda 轮片直径	180mm (7")
No Load Speed (RPM) Kelajuan Tanpa Beban 回转数	8,500
Dimensions (L x W x H) Dimensi 体积	450x200x144mm (17-3/4"x7-7/8"x5-5/8")
Net Weight Berat Bersih 净重	5.42 - 5.93kg (12 - 13.1lbs)
Power Supply Cord Kabel Wayar 电源线	2.5m (8.2ft)

GA7060 180mm (7")

218

Angle Grinder Pengisar Sudut 角向磨光机



- Motor more durable for heavy duty applications**
Motor lebih tahan lama untuk aplikasi tugas berat
马达更耐用

Standard Equipment: Side Grip, Wheel Cover, Lock Nut Wrench



Trigger Switch Suis Pemicu 扳机开关



Continuous Rating Input Input Kuasa Berterusan 额定输入功率	2,200W
Wheel Diameter Diameter Roda 轮片直径	180mm (7")
No Load Speed (RPM) Kelajuan Tanpa Beban 回转数	8,500
Dimensions (L x W x H) Dimensi 体积	450x200x144mm (17-3/4"x7-7/8"x5-5/8")
Net Weight Berat Bersih 净重	5.38 - 5.89kg (11.9 - 13lbs)
Power Supply Cord Kabel Wayar 电源线	2.5m (8.2ft)

GA7020 180mm (7")

204

Angle Grinder Pengisar Sudut 角向磨光机



- Powerful 2,200W Motor for Faster Material Removal**
Motor berkuasa 2,200W untuk pengisaran yang lebih cepat
功率强大的 2,200W 马达提供更快的研磨

Standard Equipment: Side Grip, Wheel Cover, Lock Nut Wrench



Trigger Switch Suis Pemicu 扳机开关



Continuous Rating Input Input Kuasa Berterusan 额定输入功率	2,200W
Wheel Diameter Diameter Roda 轮片直径	180mm (7")
No Load Speed (RPM) Kelajuan Tanpa Beban 回转数	8,500
Dimensions (L x W x H) Dimensi 体积	473x200x140mm (18-5/8"x7-7/8"x5-1/2")
Net Weight Berat Bersih 净重	5.56 - 6.06kg (12.26 - 13.36lbs)
Power Supply Cord Kabel Wayar 电源线	2.5m (8.2ft)

Cordless
Tanpa Kabel 无线LED Flashlight
Lampu Suis LED
LED照明灯Vacuum Cleaner
Pembersih Vakuum
吸尘器Drilling / Fastening
Gergaji / Pengisar
钻孔 / 磨削Impact Drilling / Demolition
Gergaji / Pengisar
冲击钻孔 / 拆除Cutting
Pemotong
切割Grinding / Sanding
Pengisar / Poles
磨削 / 打磨Sawing
Gergaji
锯切Planing / Routing
Pengisaran / Tengam
磨削 / 磨削Others
Lain-lain
其他Outdoor Power Equipment
Alatan Kuasa Luar
户外动力设备Makita
INT

GRINDING | SANDING

Cordless
Tanpa Kabel / 无线式

LED Flashlight
Lampu Suhu LED
LED 闪光灯

Vacuum Cleaner
Pembersih Vakuum
吸尘器

Drilling | Fastening
Gergaji / Pengikat
钻孔 / 紧固

Impact Drilling | Demolition
Gergaji / Pemecah
冲击钻孔 / 拆除加工

Cutting
Pemotong
切割

Grinding | Sanding
Pengisar / Pasir
磨削 / 打磨

Sawing
Gergaji
锯切

Planing | Routing
Pengipatan / Trogram
刨削 / 雕刻

Others
Lain-lain
其他

Outdoor Power Equipment
Alat-alat Tenaga Luar
户外产品

Makita
Makita

GA7040R 180mm (7")

204 W

Angle Grinder Pengisar Sudut 角向磨光机



Trigger Switch Suis Pemicu 扳机开关

- Superior heavy duty motor with outstanding durability
Motor tugas berat unggul dengan ketahanan yang luar biasa
耐用性卓越的马达



Standard Equipment: Side Grip, Wheel Cover, Lock Nut Wrench



Continuous Rating Input Input Kuasa Berterusan 额定输入功率	2,600W
Wheel Diameter Diameter Roda 轮片直径	180mm (7")
No Load Speed (RPM) Kelajuan Tanpa Beban 回转速数	8,500
Dimensions (L x W x H) Dimensi 体积	503x200x140mm (19-3/4"x7-7/8"x5-1/2")
Net Weight Berat Bersih 净重	6.48 - 6.98kg (14.3 - 15.4lbs)
Power Supply Cord Kabel Wayar 电源线	2.5m (8.2ft)



GA9050 230mm (9")

204 W

Angle Grinder Pengisar Sudut 角向磨光机



Trigger Switch Suis Pemicu 扳机开关

- Compact gear housing increases maximum cutting depth by 4mm
Kotak gear padat untuk meningkatkan kedalaman pemotongan maksimum kepada 4mm
紧凑的齿轮箱增加最大切割深度至4mm



Standard Equipment: Side Grip, Wheel Cover, Lock Nut Wrench



Continuous Rating Input Input Kuasa Berterusan 额定输入功率	2,000W
Wheel Diameter Diameter Roda 轮片直径	230mm (9")
No Load Speed (RPM) Kelajuan Tanpa Beban 回转速数	6,600
Dimensions (L x W x H) Dimensi 体积	432x250x132mm (17"x9-7/8"x5-3/16")
Net Weight Berat Bersih 净重	4.64 - 6.94kg (10.2 - 15.3lbs)
Power Supply Cord Kabel Wayar 电源线	2.5m (8.2ft)

GA9061R 230mm (9")

218 W

Angle Grinder Pengisar Sudut 角向磨光机



Trigger Switch Suis Pemicu 扳机开关

- Motor more durable for heavy duty applications
Motor lebih tahan lama untuk aplikasi tugas berat
马达更耐用



Standard Equipment: Side Grip, Wheel Cover, Lock Nut Wrench



Continuous Rating Input Input Kuasa Berterusan 额定输入功率	2,200W
Wheel Diameter Diameter Roda 轮片直径	230mm (9")
No Load Speed (RPM) Kelajuan Tanpa Beban 回转速数	6,600
Dimensions (L x W x H) Dimensi 体积	450x250x145mm (17-3/4"x9-7/8"x5-3/4")
Net Weight Berat Bersih 净重	5.68 - 8.04kg (12.5 - 17.7lbs)
Power Supply Cord Kabel Wayar 电源线	2.5m (8.2ft)

GA9060R 230mm (9")

218 W

Angle Grinder Pengisar Sudut 角向磨光机



Trigger Switch Suis Pemicu 扳机开关

- Powerful 2,200W motor
Motor berkuasa 2,200W
强力2,200W马达



Standard Equipment: Side Grip, Wheel Cover, Lock Nut Wrench



Continuous Rating Input Input Kuasa Berterusan 额定输入功率	2,200W
Wheel Diameter Diameter Roda 轮片直径	230mm (9")
No Load Speed (RPM) Kelajuan Tanpa Beban 回转速数	6,600
Dimensions (L x W x H) Dimensi 体积	450x250x144mm (17-3/4"x9-7/8"x5-5/8")
Net Weight Berat Bersih 净重	5.52 - 7.88kg (12.8 - 17.4lbs)
Power Supply Cord Kabel Wayar 电源线	2.5m (8.2ft)

GRINDING | SANDING

GA9060 230mm (9") 218 W

Angle Grinder
Pengisar Sudut
角向磨光机



Trigger Switch
Suis Pemacu 扳机开关



- **Motor more durable for heavy duty applications**
Motor lebih tahan lama untuk aplikasi tugas berat
马达更耐用

Standard Equipment: Side Grip, Wheel Cover, Lock Nut Wrench



Continuous Rating Input Input Kuasa Berterusan 额定输入功率	2,200W
Wheel Diameter Diameter Roda 轮片直径	230mm (9")
No Load Speed (RPM) Kelajuan Tanpa Beban 回转数	6,600
Dimensions (L x W x H) Dimensi 体积	450x250x144mm (17-3/4"x9-7/8"x5-5/8")
Net Weight Berat Bersih 净重	5.50 - 7.86kg (12.1 - 17.3lbs)
Power Supply Cord Kabel Wayar 电源线	2.5m (8.2ft)

GA9020 230mm (9") 204 W

Angle Grinder
Pengisar Sudut
角向磨光机



Trigger Switch
Suis Pemacu 扳机开关



- **Spiral bevel gears more efficient transfer of energy**
Gear serong lingkaran untuk pemindahan tenaga yang lebih cekap
螺旋锥齿轮高效输送能源

Standard Equipment: Side Grip, Wheel Cover, Lock Nut Wrench



Continuous Rating Input Input Kuasa Berterusan 额定输入功率	2,200W
Wheel Diameter Diameter Roda 轮片直径	230mm (9")
No Load Speed (RPM) Kelajuan Tanpa Beban 回转数	6,000
Dimensions (L x W x H) Dimensi 体积	473x249x140mm (18-5/8"x9-3/4"x5-1/2")
Net Weight Berat Bersih 净重	5.76 - 8.05kg (12.7 - 17.8lbs)
Power Supply Cord Kabel Wayar 电源线	2.5m (8.2ft)



SA5040C 125mm (5") 318 W

Angle Sander
Pengampelas Sudut
角向抛光机



- **Electronic current limiter prevents motor burnout due to overloading**
Pengehad arus elektronik mencegah motor dari terbakar yang disebabkan oleh beban lampau
电子电流限制器可防止超负荷引起的马达烧毁

Standard Equipment: Pad, Side Grip, Head Cover



Continuous Rating Input Input Kuasa Berterusan 额定输入功率	1,400W
Wheel Diameter Diameter Roda 轮片直径	125mm (5")
Capacity Kapasiti 能力	Pad : 115mm (4-1/2")
No Load Speed (RPM) Kelajuan Tanpa Beban 回转数	2,000-7,800
Dimensions (L x W x H) Dimensi 体积	315x115x121mm (12-3/8"x4-1/2"x4-3/4")
Net Weight Berat Bersih 净重	2.5 - 3.7kg (5.5 - 8.2lbs)
Power Supply Cord Kabel Wayar 电源线	2.5m (8.2ft)

PK5001C 125mm (5") 318 W

Angle Sander
Pengampelas Sudut
角向抛光机



- **Ideal one for effective stone polishing**
Untuk penggilap batu yang berkesan
有效的石材抛光

Standard Equipment: Side Grip, Lock Nut Wrench



Continuous Rating Input Input Kuasa Berterusan 额定输入功率	1,400W
Wheel Diameter Diameter Roda 轮片直径	125mm (5")
Capacity Kapasiti 能力	Pad : 115mm (4-1/2")
No Load Speed (RPM) Kelajuan Tanpa Beban 回转数	2,000-6,800
Dimensions (L x W x H) Dimensi 体积	328x80x126mm (12-7/8"x3-1/8"x5")
Net Weight Berat Bersih 净重	2.4 - 2.9kg (5.3 - 6.4lbs)
Power Supply Cord Kabel Wayar 电源线	4.0m (13.1ft)

Cordless
Tanpa Kabel 无线

LED Flashlight
Lampu Suhu LED
LED照明灯

Vacuum Cleaner
Penjimat Vakuum
吸尘器

Drilling / Fastening
Gergaji / Pengikat
钻孔 / 紧固

Impact Drilling / Demolition
Gergaji / Pemusnah
冲击钻孔 / 拆除

Cutting
Pemotong
切割

Grinding / Sanding
Pengisar / Poles
打磨 / 抛光

Sanding
Gergaji
打磨

Planing / Routing
Penghalus / Tonggong
刨平 / 开槽

Others
Lain-lain
其他

Outdoor Power Equipment
Alatan Kuasa Luar
户外动力设备

makita
工具

GRINDING | SANDING

GV5010 125mm (5")

64 W

Disc Sander

Pelicin Piring
盘式砂光机



- **For faster and easier removal of paint/ rust**
Untuk penyingkiran cat / karat yang lebih cepat dan mudah
更快、更容易去除油漆/锈蚀

Standard Equipment: Abrasive Disc, Plastic Pad, Side Grip,
Hex socket head bolt, Washer, Hex Wrench



Continuous Rating Input Input Kuasa Berterusan 额定输入功率	440W
Abrasive Disc Size Saiz Cakera 磨盘尺寸	125mm (5")
Capacity Kapasiti 能力	Pad: 120mm (4-3/4")
No Load Speed (RPM) Kelajuan Tanpa Beban 回转数	4,500
Dimensions (L x W x H) Dimensi 体积	200x74x181mm (7-7/8"x2-15/16"x7-1/8")
Net Weight Berat Bersih 净重	1.2kg (2.6lbs)
Power Supply Cord Kabel Wayar 电源线	2.5m (8.2ft)

GV6010 150mm (6")

64 W

Disc Sander

Pelicin Piring
盘式砂光机



- **Powerful 440W motor for fast material removal**
Motor berkuasa 440W untuk penyingkiran bahan cepat
功率强劲的440W马达

Standard Equipment: Abrasive Disc, Plastic Pad, Side Grip,
Hex socket head bolt, Washer, Hex Wrench



Continuous Rating Input Input Kuasa Berterusan 额定输入功率	440W
Abrasive Disc Size Saiz Cakera 磨盘尺寸	150mm (6")
Capacity Kapasiti 能力	Pad: 120mm (4-3/4")
No Load Speed (RPM) Kelajuan Tanpa Beban 回转数	4,500
Dimensions (L x W x H) Dimensi 体积	200x74x181mm (7-7/8"x2-15/16"x7-1/8")
Net Weight Berat Bersih 净重	1.2kg (2.6lbs)
Power Supply Cord Kabel Wayar 电源线	2.5m (8.2ft)

GV7000C 180mm (7")

303 W

Disc Sander

Pelicin Piring
盘式砂光机

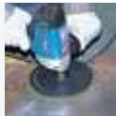

- **Motor-over-pad design for better balance and control**
Reka bentuk motor-over-pad untuk keseimbangan dan kawalan yang lebih baik
更好的平衡易于控制

Standard Equipment: Abrasive Disc, Rubber Pad,
Lock Nut Wrench, Wrench, Side Grip



Continuous Rating Input Input Kuasa Berterusan 额定输入功率	900W
Abrasive Disc Size Saiz Cakera 磨盘尺寸	180mm (7")
Capacity Kapasiti 能力	Pad: 180mm (7")
No Load Speed (RPM) Kelajuan Tanpa Beban 回转数	2,500-4,700
Overall Length Panjang Keseluruhan 总长度	210mm (8-1/4")
Net Weight Berat Bersih 净重	2.1kg (4.6lbs)
Power Supply Cord Kabel Wayar 电源线	2.5m (8.2ft)

9215SB 150mm (6")

100 W

Disc Sander

Pelicin Piring
盘式砂光机



- **Powerful motor in well-balanced body for fast and steady sanding**
Motor berkuasa dengan badan yang seimbang
强劲的马达平衡良好及机身

Standard Equipment: Rubber Pad, Lock Nut Wrench,
Wrench, Side Grip



Continuous Rating Input Input Kuasa Berterusan 额定输入功率	570W
Wire Cup Brush Berus Wayar Cawan 杯型钢丝刷	110mm (4-3/8")
Abrasive Disc Size Saiz Cakera 磨盘尺寸	150mm (6")
No Load Speed (RPM) Kelajuan Tanpa Beban 回转数	4,500
Overall Length Panjang Keseluruhan 总长度	225mm (8-7/8")
Net Weight Berat Bersih 净重	2.9kg (6.3lbs)
Power Supply Cord Kabel Wayar 电源线	2.5m (8.2ft)

9237C 180mm (7")

303 W

Polisher

Penggilap
打蜡机



- **Fast and powerful for clear coat finishes**
Cepat dan berkuasa untuk kemasatan kot yang jelas
快速清除涂层

Standard Equipment: Side Handle, Hex Wrench, Wool Pad



Continuous Rating Input Input Kuasa Berterusan 额定输入功率	1,200W
Capacity Kapasiti 能力	Wool Pad: 180mm (7") Wool Bonnet: 180mm (7")
No Load Speed (RPM) Kelajuan Tanpa Beban 回转数	0 - 3,200
Dimensions (L x W x H) Dimensi 体积	431x198x187mm (17"x7-3/4"x7-3/8")
Net Weight Berat Bersih 净重	3.2 - 3.4kg (7.0 - 7.5lbs)
Power Supply Cord Kabel Wayar 电源线	2.5m (8.2ft)

Cordless
Terasa bebas kabel

LED Flashlight
Lampu suluh LED
LED 照明灯

Vacuum Cleaner
Pembersih Vakuum
吸尘器

Drilling / Fastening
Gores / Pengikat
钻孔 / 紧固

Impact Drilling / Demolition
Gores / Perseki
冲击钻孔 / 拆除加工

Cutting
Pemotong
切割

Grinding / Sanding
Pengisar / Pekaik
磨削 / 打磨

Sawing
Gergaji
锯切

Planing / Routing
Pengijatan / Trogram
刨削 / 刨花

Others
Lain-lain
其他

Outdoor Power Equipment
Alatan Kuasa Luar
户外产品

Makita
MAKITA

GRINDING | SANDING

PO5000C 125mm (5")

318

Random Orbit Sander

Pelicin Orbit
砂光机



- **Wide variety of optional accessories (Pad, Sponge pad, Felt pad, Wool pad)**
Pelbagai aksesori pilihan (pad, pad sponge, pad felt, pad bulu)
各种可选配件 (垫, 海绵垫, 毡垫, 羊毛垫)



PO5000C

VIDEO CLIP
Models and specs may vary by country

Standard Equipment: Hex Wrench



Continuous Rating Input Input Kuasa Berterusan 额定输入功率	900W
Pad Size Saiz Pad 垫大小	125mm (5")
Orbits Per Minute (OPM) Bilangan Putaran 轨道转速	0 - 6,800
Strokes Per Minute (SPM) Kelajuan Strok 冲程速度	0 - 13,600
No Load Speed (RPM) Kelajuan Tanpa Beban 回转数	0 - 780
Orbit Diameter Kelajuan Tanpa Beban 回转数	5.5 mm (7/32")
Dimensions (L x W x H) Dimensi 体积	451x123x134mm (17-3/4"x4-7/8"x5-1/4")
Net Weight Berat Bersih 净重	2.8 - 3.0kg (6.2 - 6.5lbs)
Power Supply Cord Kabel Wayar 电源线	4.0m (13.1ft)

PO6000C 150mm (6")

Random Orbit Sander

Pelicin Orbit
砂光机



- **Wide variety of optional accessories (Pad, Sponge pad, Felt pad, Wool pad)**
Pelbagai aksesori pilihan (pad, pad sponge, pad felt, pad bulu)
各种可选配件 (垫, 海绵垫, 毡垫, 羊毛垫)



Standard Equipment: Hex Wrench



Continuous Rating Input Input Kuasa Berterusan 额定输入功率	900W
Pad Size Saiz Pad 垫大小	150mm (6")
Orbits Per Minute (OPM) Bilangan Putaran 轨道转速	0 - 6,800
Strokes Per Minute (SPM) Kelajuan Strok 冲程速度	0 - 13,600
No Load Speed (RPM) Kelajuan Tanpa Beban 回转数	0 - 780
Orbit Diameter Kelajuan Tanpa Beban 回转数	5.5mm (7/32")
Dimensions (L x W x H) Dimensi 体积	451x148x126mm (17-3/4"x5-7/8"x5")
Net Weight Berat Bersih 净重	2.8 - 3.0kg (6.2 - 6.5lbs)
Power Supply Cord Kabel Wayar 电源线	4.0m (13.1ft)

PV7000C 180mm (7")

303

Polisher

Penggilap
抛光机



- **Lightweight for reduced operator fatigue**
Ringan untuk mengurangkan keletihan pengguna
轻量不易引起疲劳



Standard Equipment: Side Handle, Pad, Wrench

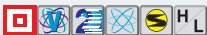

Continuous Rating Input Input Kuasa Berterusan 额定输入功率	900W
Capacity Kapasiti 能力	Pad: 180mm (7") Wool Bonnet: 180mm (7")
No Load Speed (RPM) Kelajuan Tanpa Beban 回转数	600 - 2,100
Overall Length Panjang Keseluruhan 总长度	210mm (8-1/4")
Net Weight Berat Bersih 净重	2.1kg (4.6lbs)
Power Supply Cord Kabel Wayar 电源线	2.5m (8.2ft)

GD0600 6mm (1/4")

325

Die Grinder

Gerinda Lurus
电磨



- **Large Flush-Mount Paddle Switch for Comfortable Operation**
Suis Flush-mount mudah digunakan
大型平装式扳钮开关易于操作



Standard Equipment: Wrench x2



Continuous Rating Input Input Kuasa Berterusan 额定输入功率	400W
Capacity Kapasiti 能力	Collet: 3,6mm or 1/8", 1/4"
Wheel Diameter Diameter Roda 轮片直径	38mm (1-1/2")
No Load Speed (RPM) Kelajuan Tanpa Beban 回转数	25,000
Dimensions (L x W x H) Dimensi 体积	358x82x82mm (14-1/8"x3-1/4"x3-1/4")
Net Weight Berat Bersih 净重	1.71 - 1.87kg (3.77 - 4.12lbs)
Power Supply Cord Kabel Wayar 电源线	2.5m (8.2ft)

GD0601 6mm (1/4")

325

Die Grinder

Gerinda Lurus
电磨



- **Powerful 400W motor**
Motor berkuasa 400W
强力400W马达



Standard Equipment: Wrench x2



Continuous Rating Input Input Kuasa Berterusan 额定输入功率	400W
Capacity Kapasiti 能力	Collet: 3,6mm or 1/8", 1/4"
Wheel Diameter Diameter Roda 轮片直径	38mm (1-1/2")
No Load Speed (RPM) Kelajuan Tanpa Beban 回转数	25,000
Dimensions (L x W x H) Dimensi 体积	359x82x82mm (14-1/8"x3-1/4"x3-1/4")
Net Weight Berat Bersih 净重	1.68 - 1.84kg (3.70 - 4.06lbs)
Power Supply Cord Kabel Wayar 电源线	2.5m (8.2ft)

Cordless
Tanpa Kabel 无线LED Flashlight
Lampu Suhu LED
LED照明灯Vacuum Cleaner
Penjimat Vakuum
吸尘器Drilling / Fastening
Gergaji / Pengikat
钻 / 紧固Impact Drilling / Demolition
Gergaji / Pemusnah
冲击钻 / 破拆Cutting / Finishing
Pemotong / Finishing
切割 / 打磨Grinding / Sanding
Penggilap / Poles
打磨 / 抛光Sawing
Gergaji
锯切Planing / Routing
Penghalus / Tanggapan
刨 / 修边Others
Lain-lain
其他Outdoor Power Equipment
Alatan Kuasa Luar
户外动力设备Thakita
THAKITA

GRINDING | SANDING

GD0603 6mm (1/4")

64

Die Grinder

Gerinda Lurus
电磨



- **Compact and easy handling**
Padat dan mudah digunakan
紧凑且易于使用



Standard Equipment: **Spanner, Wheel points**



Continuous Rating Input Input Kuasa Berterusan 额定输入功率	240W
Capacity Kapasiti 能力	Collet: 6mm or 1/4"
Max Wheel Diameter Diameter Roda 轮片直径	19mm (3/4")
No Load Speed (RPM) Kelajuan Tanpa Beban 回转速数	28,000
Diameter of Grip Diameter Silinder 圆筒直径	65mm
Dimensions (L x W x H) Dimensi 体积	289x64x67mm (11-3/8"x2-1/2"x2-5/8")
Net Weight Berat Bersih 净重	0.98kg (2.16lbs)
Power Supply Cord Kabel Wayar 电源线	2.5m (8.2ft)

GD0800C 8mm (1/4")

318

Die Grinder

Gerinda Lurus
电磨



- **Electronic Controller for Operator Convenience**
Pengawal elektronik untuk kemudahan pengguna
电子控制器方便使用者



Standard Equipment: **Wrench x2**

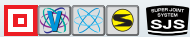

Continuous Rating Input Input Kuasa Berterusan 额定输入功率	750W
Capacity Kapasiti 能力	Collet: 3,6,8mm or 1/8", 1/4"
Wheel Diameter Diameter Roda 轮片直径	25mm (1")
No Load Speed (RPM) Kelajuan Tanpa Beban 回转速数	7,000-28,000
Dimensions (L x W x H) Dimensi 体积	371x75x75mm (14-5/8"x2-15/16"x2-15/16")
Net Weight Berat Bersih 净重	1.88kg (4.14lbs)
Power Supply Cord Kabel Wayar 电源线	2.5m (8.2ft)

GD0801C 8mm (1/4")

318

Die Grinder

Gerinda Lurus
电磨



- **Powerful 750W motor for faster material removal**
Motor berkuasa 750W untuk pengisaran yang lebih cepat
功率强大的 750W 马达提供更快的研磨



Standard Equipment: **Side Handle, Wrench x2**

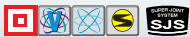

Continuous Rating Input Input Kuasa Berterusan 额定输入功率	750W
Capacity Kapasiti 能力	Collet: 8mm (1/4")
Max Wheel Diameter Diameter Roda 轮片直径	25mm (1")
No Load Speed (RPM) Kelajuan Tanpa Beban 回转速数	7,000-29,000
Dimensions (L x W x H) Dimensi 体积	390x75x88mm (15-3/8"x2-15/16"x3-1/2")
Net Weight Berat Bersih 净重	1.96 - 1.97kg (4.32 - 4.34lbs)
Power Supply Cord Kabel Wayar 电源线	2.5m (8.2ft)

GD0811C 8mm (1/4")

318

Die Grinder

Gerinda Lurus
电磨



- **Ideal for grinding internal surfaces, removing paint etc. using with flap wheel**
Sesuai untuk mengisar permukaan dalaman, cat dan lain-lain
适用于研磨内表面, 使用皮瓣轮去除油漆等



Standard Equipment: **Side Handle, Wrench x2**

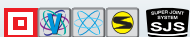

Continuous Rating Input Input Kuasa Berterusan 额定输入功率	750W
Capacity Kapasiti 能力	Collet: 8mm (1/4")
Max Wheel Diameter Diameter Roda 轮片直径	50mm (2")
No Load Speed (RPM) Kelajuan Tanpa Beban 回转速数	1,800-7,000
Dimensions (L x W x H) Dimensi 体积	390x75x88mm (15-3/8"x2-15/16"x3-1/2")
Net Weight Berat Bersih 净重	1.99 - 2.00kg (4.39 - 4.41lbs)
Power Supply Cord Kabel Wayar 电源线	2.5m (8.2ft)

GS5000 125mm (5")

204

Straight Grinder

Pengisar Lurus
直向砂轮机



- **Powerful 750W motor**
Motor berkuasa 750W
强力750W马达



Standard Equipment: **Hex Wrench, Wrench**



Continuous Rating Input Input Kuasa Berterusan 额定输入功率	750W
Wheel Diameter Diameter Roda 轮片直径	125mm (5")
Hole Diameter Diameter Lubang 孔直径	12.7, 20mm (1/2, 13/16")
No Load Speed (RPM) Kelajuan Tanpa Beban 回转速数	5,600
Dimensions (L x W x H) Dimensi 体积	590x189x116mm (23-1/4"x7-7/16"x4-9/16")
Net Weight Berat Bersih 净重	5.0 - 5.2kg (11.0 - 11.5lbs)
Power Supply Cord Kabel Wayar 电源线	2.5m (8.2ft)

Cordless
Terasa bebas kabus

LED Flashlight
Lampau Cahaya LED
LED 闪光灯

Vacuum Cleaner
Pembersih Vakuum
吸尘器

Drilling / Fastening
Dremel / Pengikat
电钻 / 紧固件

Impact Drilling / Demolition
Gimul / Pemusnah
电钻钻头 / 拆除加工

Grinding / Sanding
Pengisar / Pasir
打磨 / 砂磨

Sawing
Mengisar
切割

Planing / Routing
Pengisaran / Trogram
刨削 / 刨花

Others
Lain-lain
其他

Outdoor Power Equipment
Alatan Kuasa Luar
户外动力设备

Makita
MAKITA

GRINDING | SANDING

GS6000 150mm (6")

204

Straight Grinder

Pengisar Lurus
直向砂轮机



- **Powerful 750W motor**
Motor berkuasa 750W
强力750W马达



Standard Equipment: Hex Wrench, Wrench



Continuous Rating Input Input Kuasa Berterusan 额定输入功率	750W
Wheel Diameter Diameter Roda 轮片直径	150mm (6")
Hole Dia. Diameter Lubang 孔直径	12.7, 20mm (1/2, 13/16")
No Load Speed (RPM) Kelajuan Tanpa Beban 回转数	5,600
Dimensions (L x W x H) Dimensi 体积	590x216x130mm (23-1/4"x8-1/2"x5-1/8")
Net Weight Berat Bersih 净重	5.2 - 5.4kg (11.4 - 12.0lbs)
Power Supply Cord Kabel Wayar 电源线	2.5m (8.2ft)

TM3000C

459

Multi Tool

Mesin Pemotong Berbilang Fungsi
多功能切割打磨机



- **Powerful 320W motor with improved performance**
Motor berkuasa 320W dengan prestasi yang lebih baik
强力320W马达, 改进的性能



Standard Equipment: Hex Wrench



Continuous Rating Input Input Kuasa Berterusan 额定输入功率	320W
Strokes Per Minute (SPM) Kelajuan Strok 冲程速度	6,000-20,000
Dimensions (L x W x H) Dimensi 体积	275x64x92mm (10-7/8"x2-1/2"x3-5/8")
Net Weight Berat Bersih 净重	1.4 - 1.5kg (3.2 - 3.3lbs)
Power Supply Cord Kabel Wayar 电源线	5.0m (16.4ft)



TM3010CX6

459

Multi Tool

Mesin Pemotong Berbilang Fungsi
多功能切割打磨机

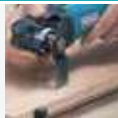

- **Toolless clamp system for fast accessory installation**
Sistem pemasangan aksesori tanpa alat
免工具快速安装与更换配件



Standard Equipment: Multi Tool Plunge Cut Saw Blade 32, Segment Saw Blade 85, Sanding Pad



Continuous Rating Input Input Kuasa Berterusan 额定输入功率	320W
Strokes Per Minute (SPM) Kelajuan Strok 冲程速度	6,000-20,000
Dimensions (L x W x H) Dimensi 体积	283x68x87mm (11-1/8"x2-11/16"x3-7/16")
Net Weight Berat Bersih 净重	1.6 - 1.7kg (3.7 - 3.9lbs)
Power Supply Cord Kabel Wayar 电源线	2.5m (8.2ft)



GB602 150mm (6")

Bench Grinder

Pengisar
台式砂轮机



- **Wheel covers have built-in task lights**
Lampu tugas terbina dalam pelindung roda
轮罩具有内置任务灯



Standard Equipment: Safety Eye Shield, Protection glasses, Wrench x2



Continuous Rating Input Input Kuasa Berterusan 额定输入功率	250W
Wheel Diameter Diameter Roda 轮片直径	150mm (6")
Wheel Width Lebar Roda 轮片宽度	16mm (5/8")
Hole Dia. Diameter Lubang 孔直径	12.7mm (1/2")
H.P.	1/3
No Load Speed (RPM) Kelajuan Tanpa Beban 回转数	2,850 (50Hz)/ 3,450 (60Hz)
Dimensions (L x W x H) Dimensi 体积	375x205x286mm (14-49/64"x8"x11-17/64")
Net Weight Berat Bersih 净重	9.31 - 9.08kg (20.02 - 20.52lbs)

GB801 205mm (8")

Bench Grinder

Pengisar
台式砂轮机



- **Adjustable wheel balance feature reduces vibration**
Pelarasanimbangan roda mengurangkan getaran
平衡调整减少振动



Standard Equipment: Safety Eye Shield, Protection glasses, Wrench x2



Continuous Rating Input Input Kuasa Berterusan 额定输入功率	550W
Wheel Diameter Diameter Roda 轮片直径	205mm (8")
Wheel Width Lebar Roda 轮片宽度	19mm (3/4")
Hole Dia. Diameter Lubang 孔直径	15.88mm (5/8")
H.P.	3/4
No Load Speed (RPM) Kelajuan Tanpa Beban 回转数	2,850 (50Hz)/ 3,450 (60Hz)
Dimensions (L x W x H) Dimensi 体积	395x265x333mm (15-9/16"x10-7/16"x13-7/64")
Net Weight Berat Bersih 净重	19.91 - 19.63kg (43.89 - 43.28lbs)

Cordless
Tampa Kabel 无线

LED Flashlight
Lampu Suluh LED
LED照明灯

Vacuum Cleaner
Penjimat Vakuum
吸尘器

Drilling / Fastening
Gergaji / Pasang
钻孔 / 紧固

Impact Drilling / Demolition
Gergaji / Pasang
冲击钻孔 / 拆除

Cutting / Finishing
Pemotong / Finishing
切割 / 打磨

Grinding / Sanding
Pengisar / Pasang
打磨 / 砂磨

Sanding / Grinding
Gergaji
打磨 / 砂磨

Planing / Routing
Pengisar / Tanggapan
刨平 / 铣削

Others
Lain-lain
其他

Outdoor Power Equipment
Alatan Kuasa Luar
户外动力设备

Makita
MAKITA

GRINDING | SANDING

PC5010C 125mm (5")

Concrete Planer

Pengampelas
砂光机



• Compact and Lightweight for High Production Work

Kompak dan ringan untuk kerja pengeluaran yang tinggi
紧凑轻巧型，更有效率地工作

Standard Equipment: Lock Nut Wrench



Continuous Rating Input Input Kuasa Berterusan 额定输入功率	1,400W
Wheel Diameter Diameter Roda 轮片直径	125mm (5")
Hole Diameter Diameter Lubang 孔直径	22.23mm (7/8")
No Load Speed (RPM) Kelajuan Tanpa Beban 回转数	4,000 - 9,000
Dimensions (L x W x H) Dimensi 体积	350x231x179mm (13-3/4"x9-1/8"x7")
Net Weight Berat Bersih 净重	2.5 - 3.6kg (5.5 - 7.9lbs.)
Power Supply Cord Kabel Wayar 电源线	4.0m (13.1ft)

PC5000C 125mm (5")

253

Concrete Planer

Pengampelas
砂光机



• Electronic current limiter helps protect the motor from overload

Pengehad arus elektronik melindungi motor daripada beban lampau
电子电流限制器有助于防止马达超负荷

Standard Equipment: Lock Nut Wrench, Hex Wrench, Dust Bag Assembly



Continuous Rating Input Input Kuasa Berterusan 额定输入功率	1,400W
Wheel Diameter Diameter Roda 轮片直径	125mm (5")
Hole Dia. Diameter Lubang 孔直径	22.23mm (7/8")
No Load Speed (RPM) Kelajuan Tanpa Beban 回转数	10,000
Dimensions (L x W x H) Dimensi 体积	437x235x195mm (17-1/8"x9-1/4"x7-5/8")
Net Weight Berat Bersih 净重	4kg (8.9lbs)
Power Supply Cord Kabel Wayar 电源线	5.0m (16.4ft)

PC5001C 125mm (5")

253

Concrete Planer

Pengampelas
砂光机



• Soft start suppresses start-up reaction for more precision and longer tool life

Penghidupan secara perlahan untuk ketepatan yang lebih baik dan memanjangkan hayat alat
缓速启动提高准确性和延长工具使用寿命

Standard Equipment: Lock Nut Wrench, Hex Wrench, Dust Bag Assembly



Continuous Rating Input Input Kuasa Berterusan 额定输入功率	1,400W
Wheel Diameter Diameter Roda 轮片直径	125mm (5")
No Load Speed (RPM) Kelajuan Tanpa Beban 回转数	10,000
Dimensions (L x W x H) Dimensi 体积	479x182x195mm (18-13/16"x7-1/8"x7-5/8")
Net Weight Berat Bersih 净重	4kg (8.9lbs)
Power Supply Cord Kabel Wayar 电源线	5m (16.4ft)

PW5001C 125mm (5")

318

Stone Polisher

Penggilap Batu
水磨石机



• Variable speed control dial enables user to match the speed to the application

Pilihan kawalan kelajuan berubah untuk pelbagai aplikasi
变速控制选择适合多种应用

Standard Equipment: Rubber Pad, Side Grip, Wrench, Head Cover



Continuous Rating Input Input Kuasa Berterusan 额定输入功率	900W
Capacity Kapasiti 能力	Pad: 100-125mm (4-5")
No Load Speed (RPM) Kelajuan Tanpa Beban 回转数	2,000-4,000
Overall Length Panjang Keseluruhan 总长度	359mm (14-1/8")
Net Weight Berat Bersih 净重	2.3 - 2.6kg (5.1 - 5.7lbs)
Power Supply Cord Kabel Wayar 电源线	4.0m (13.1ft)

9404 100mm x 610mm (4" x 24")

303

Belt Sander

Pengampelas
带式砂光机



• Powerful 1,010W motor for fast material removal

Motor berkuasa 1,010W untuk pengisaran yang lebih cepat
功率强大的 1,010W 马达提供更快的研磨

Standard Equipment: Abrasive Belt, Dust bag assembly



Continuous Rating Input Input Kuasa Berterusan 额定输入功率	1,010W
Belt Size Saiz Tali Pnggamp 皮带尺寸	100 x 610mm (4" x 24")
Belt Speed Kelajuan Tali Pnggamp 皮带速度	210-440m/min (690-1,440ft/min)
Overall Length Panjang Keseluruhan 总长度	334mm (13-1/8")
Net Weight Berat Bersih 净重	4.8kg (10.6lbs)
Power Supply Cord Kabel Wayar 电源线	5.0m (16.4ft)

GRINDING | SANDING

9903 76mm x 533mm (3" x 21")

303

Belt Sander Pengampelas 带式砂光机



- Sands wood or metal and removes paint and rust
Melicinkan kayu atau logam, menghilangkan cat dan karat
打磨木头或金属，去除油漆和铁锈



Standard Equipment: Abrasive Belt, Dust bag assembly



Continuous Rating Input Input Kuasa Berterusan 额定输入功率	1,010W
Belt Size Saiz Tali Pinggang 皮带尺寸	76 x 533mm (3" x 21")
Belt Speed Kelajuan Tali Pinggang 皮带速度	210 - 440m/min (690 - 1,440 ft/min)
Overall Length Panjang Keseluruhan 总长度	296mm (11-5/8")
Net Weight Berat Bersih 净重	4.3kg (9.5lbs)
Power Supply Cord Kabel Wayar 电源线	5.0m (16.4ft)

9401 100mm x 610mm (4" x 24")

153

Belt Sander Pengampelas 带式砂光机



- Highly-efficient dust collection system for clean work environment
Sistem pengumpulan habuk yang cekap untuk mewujudkan persekitaran kerja bersih
高效的集尘系统打造清洁工作环境



Standard Equipment: Abrasive Belt, Carbon Plate, Step, Dust bag assembly



Continuous Rating Input Input Kuasa Berterusan 额定输入功率	940W
Belt Size Saiz Tali Pinggang 皮带尺寸	100 x 610mm (4" x 24")
Belt Speed Kelajuan Tali Pinggang 皮带速度	350m/min (1,150ft/min)
Overall Length Panjang Keseluruhan 总长度	374mm (14-3/4")
Net Weight Berat Bersih 净重	7.2kg (15.9lbs)
Power Supply Cord Kabel Wayar 电源线	5.0m (16.4ft)

9924DB 76mm x 610mm (3" x 24")

100

Belt Sander Pengampelas 带式砂光机



- Powerful 850W for fast material removal
Motor berkuasa 750W untuk pengiraan yang lebih cepat
功率强大的 750W 马达提供更快研磨



Standard Equipment: Abrasive Belt, Carbon Plate, Dust bag assembly



Continuous Rating Input Input Kuasa Berterusan 额定输入功率	850W
Belt Size Saiz Tali Pinggang 皮带尺寸	76 x 610, 620mm (3" x 24, 24-3/8")
Belt Speed Kelajuan Tali Pinggang 皮带速度	400m/min (1,300ft/min)
Overall Length Panjang Keseluruhan 总长度	355mm (14")
Net Weight Berat Bersih 净重	4.8kg (10.6lbs)
Power Supply Cord Kabel Wayar 电源线	5.0m (16.4ft)

9911 76mm x 457mm (3" x 18")

411

Belt Sander Pengampelas 带式砂光机



- Compact and well balanced for easy operation
Padat dan mudah digunakan
紧凑且易于使用



Standard Equipment: Abrasive Belt, Dust bag assembly



Continuous Rating Input Input Kuasa Berterusan 额定输入功率	650W
Belt Size Saiz Tali Pinggang 皮带尺寸	76 x 457mm (3" x 18")
Belt Speed Kelajuan Tali Pinggang 皮带速度	75 - 270m/min (250 - 900ft/min)
Overall Length Panjang Keseluruhan 总长度	262mm (10-3/8")
Net Weight Berat Bersih 净重	2.7kg (6lbs)
Power Supply Cord Kabel Wayar 电源线	2.5m (8.2ft)

9031 30mm x 533mm (1-3/16" x 21")

411

Belt Sander Pengampelas 带式砂光机



- Versatile for use on wood, metal, and fiberglass materials
Digunakan pada bahan kayu, logam, dan gentian kaca
多用于木材，金属和纤维玻璃材料



Standard Equipment: Abrasive Belt x10, Side Handle



Continuous Rating Input Input Kuasa Berterusan 额定输入功率	550W
Belt Size Saiz Tali Pinggang 皮带尺寸	30 x 533mm (1-1/8" x 21")
Belt Speed Kelajuan Tali Pinggang 皮带速度	200 - 1,000m/min (656 - 3,280ft/min)
Overall Length Panjang Keseluruhan 总长度	380mm (15")
Net Weight Berat Bersih 净重	2.1kg (4.6lbs)
Power Supply Cord Kabel Wayar 电源线	2.5m (8.2ft)

Cordless
Tanpa Kabel 无绳

LED Flashlight
Lampu Suhu LED
LED照明灯

Vacuum Cleaner
Penjimat Vakuum
吸尘器

Drilling / Fastening
Gergaji / Pengikat
钻 / 紧固

Impact Drilling / Demolition
Gergaji / Penanggal
冲击钻 / 拆除

Cutting
Pemotong
切割

Grinding / Sanding
Pengampelas / Pasah
打磨 / 砂磨

Sanding
Gergaji
打磨

Planing / Routing
Penghalus / Tenggang
刨 / 修边

Others
Lain-lain
其他

Outdoor Power Equipment
Alatan Kerja Luar
户外动力设备

Makita
Makita

GRINDING | SANDING

BO3710

64

Finishing Sander

Pengampelas
砂光机



- **High capacity dust bag with built-in vacuum adaptor for improved dust collection**
Beg debu kapasiti tinggi dengan penyesuai vakum terbina dalam untuk pengumpulan habuk yang lebih baik
内置空适配器的高容量集尘袋可改进集尘效果

Standard Equipment: Dust Bag, Punch Plate



Continuous Rating Input Input Kuasa Berterusan 额定输入功率	190W
Pad Size Saiz Pad 垫大小	93 x 185mm (3-5/8" x 7-1/4")
Abrasive Paper Size Saiz Kertas Pasir 砂纸尺寸	93 x 228mm (3-5/8" x 9")
Orbits Per Minute (OPM) Bilangan Putaran 轨道转速	11,000
Strokes Per Minute (SPM) Kelajuan Strok 冲程速度	22,000
Orbit Diameter Jejaki Diameter 轨道直径	2.0mm (1/16")
Dimensions (L x W x H) Dimensi 体积	253x92x154mm (10"x3-5/8"x6-1/16")
Net Weight Berat Bersih 净重	1.6kg (3.5lbs)
Power Supply Cord Kabel Wayar 电源线	2.0m (6.6ft)

9035H

Finishing Sander

Pengampelas
砂光机



- **Rubberized large paper clamp levers for easy installation/ removal of paper**
Batang pengapit getah yang besar memudahkan pemasangan dan penyingkiran kertas pasir
大号橡胶夹杆方便安装及取出砂纸

Standard Equipment: Abrasive paper x6



Continuous Rating Input Input Kuasa Berterusan 额定输入功率	180W
Pad Size Saiz Pad 垫大小	93 x 185mm (3-5/8" x 7-1/4")
Abrasive Paper Size Saiz Kertas Pasir 砂纸尺寸	93 x 228mm (3-5/8" x 9")
Orbits Per Minute (OPM) Kelajuan Ayunan 摆动速度	11,000
Dimensions (L x W x H) Dimensi 体积	236x93x146mm (9-1/4"x3-5/8"x5-3/4")
Net Weight Berat Bersih 净重	1.5kg (3.3lbs)
Power Supply Cord Kabel Wayar 电源线	2.5m (8.2ft)

BO4901

419

Finishing Sander

Pengampelas
砂光机



- **Large clamp lever for easy install/ removal of paper**
Batang pengapit yang besar memudahkan pemasangan dan penyingkiran kertas pasir
大夹杆方便安装及取出砂纸

Standard Equipment: Abrasive Paper



Continuous Rating Input Input Kuasa Berterusan 额定输入功率	330W
Pad Size Saiz Pad 垫大小	115 x 229mm (4-1/2" x 9")
Abrasive Paper Size Saiz Kertas Pasir 砂纸尺寸	115 x 280mm (4-1/2" x 11")
Orbits Per Minute (OPM) Kelajuan Ayunan 摆动速度	10,000
Overall Length Panjang Keseluruhan 总长度	289mm (11-3/8")
Net Weight Berat Bersih 净重	2.8kg (6.2lbs)
Power Supply Cord Kabel Wayar 电源线	2.5m (8.2ft)

9045B 114mm (4-1/2")

105

Finishing Sander

Pengampelas
砂光机



- **All bearing construction for smooth, long term operation**
Konstruksi galas yang sesuai untuk operasi lancar dan jangka panjang
适合平滑及长期运行的轴承结构

Standard Equipment: Abrasive paper x10



Continuous Rating Input Input Kuasa Berterusan 额定输入功率	520W
Pad Size Saiz Pad 垫大小	114 x 234mm (4-1/2" x 9-1/4")
Abrasive Paper Size Saiz Kertas Pasir 砂纸尺寸	114 x 280mm (4-1/2" x 11")
Orbits Per Minute (OPM) Kelajuan Ayunan 摆动速度	10,000
Overall Length Panjang Keseluruhan 总长度	240mm (9-1/2")
Orbit Diameter Jejaki Diameter 轨道直径	2.4mm (3/32")
Net Weight Berat Bersih 净重	2.6kg (5.7lbs)
Power Supply Cord Kabel Wayar 电源线	2.5m (8.2ft)

BO4510H

Finishing Sander

Pengampelas
砂光机



- **Large clamp lever for easy install/ removal of paper**
Batang pengapit yang besar memudahkan pemasangan dan penyingkiran kertas pasir
大夹杆方便安装及取出砂纸

Standard Equipment: Abrasive paper x6



Continuous Rating Input Input Kuasa Berterusan 额定输入功率	170W
Pad Size Saiz Pad 垫大小	110 x 100mm (4-5/16" x 3-15/16")
Abrasive Paper Size Saiz Kertas Pasir 砂纸尺寸	114 x 140mm (4-1/2" x 5-1/2")
Orbits Per Minute (OPM) Bilangan Putaran 轨道转速	12,000
Dimensions (L x W x H) Dimensi 体积	116x110x129mm (4-9/16"x4-5/16"x5-1/8")
Net Weight Berat Bersih 净重	1.1kg (2.4lbs)
Power Supply Cord Kabel Wayar 电源线	2.5m (8.2ft)

Cordless
Terasa Bebas Kabel

LED Flashlight
Lampu Suluh LED
LED 闪光灯

Vacuum Cleaner
Pembersih Vakuum
吸尘器

Drilling / Fastening
Dremel / Pengapit
电钻 / 夹钳

Impact Drilling / Demolition
Gimul / Pemusnah
电钻 / 拆卸工具

Cutting
Pemotong
切割机

Grinding / Sanding
Pengamiran / Pasir
磨削 / 打磨

Sawing
Gergaji
电锯

Planing / Routing
Pengaplan / Trogram
刨削 / 刨花

Others
Lain-lain
其他

Outdoor Power Equipment
Alatan Kuasa Luar
户外产品

Makita
MAKITA

GRINDING | SANDING

BO4556

419

Finishing Sander Pengampelas 砂光机



- 14,000OPM for fast and smooth finish sanding
14,000OPM untuk pelicinan cepat dan lancar
14,000OPM可快速平滑的打磨

Standard Equipment: Abrasive Paper, Dust Bag, Punch Plate



Continuous Rating Input Input Kuasa Berterusan 额定输入功率	200W
Pad Size Saiz Pad 垫大小	112 x 102mm (4-3/8" x 4")
Abrasive Paper Size Saiz Kertas Pasir 砂纸尺寸	114 x 140mm (4-1/2" x 5-1/2")
Orbits Per Minute (OPM) Bilangan Putaran 轨道转速	14,000
Dimensions (L x W x H) Dimensi 体积	131x112x141mm (5-1/8"x4-3/8"x5-9/16")
Net Weight Berat Bersih 净重	1.1kg (2.5lbs)
Power Supply Cord Kabel Wayar 电源线	2.0m (6.6ft)

BO6050J

325

Random Orbit Sander Pengampelas 砂光机



- Slim skirt provides higher work efficiency
in tight spaces
Kecekapan kerja yang lebih tinggi di ruang yang sempit
在狭小空间中提供更高的工作效率

Standard Equipment:
Abrasive Paper, Side Grip



BO6050

VIDEO CLIP
Models and prices
may vary by country

Continuous Rating Input Input Kuasa Berterusan 额定输入功率	750W
Pad Diameter Saiz Pad 垫大小	150mm (6")
Abrasive Disc Size Saiz Cakera 磨盘尺寸	150mm (6")
Orbits Per Minute (OPM) Bilangan Putaran 轨道转速	1,600 - 6,800
Sanding Strokes Per Minute (SPM) Menggilap Strok Seminit 每分钟打磨冲程	3,200 - 13,600
Pad Speed in Roto-orbit mode (rpm) Kelajuan Pad 垫速度	140 - 600
Orbit Diameter Jejaki Diameter 轨道直径	5.5mm (7/32")
Dimensions (L x W x H) Dimensi 体积	330x155x145mm (13"x6-1/8"x5-3/4")
Net Weight Berat Bersih 净重	2.6kg (5.7lbs)
Power Supply Cord Kabel Wayar 电源线	2.5m (8.2ft)

BO5031

419

Random Orbit Sander Pengampelas 砂光机



- Smooth finish with variable speed control
Kemasan lancar dengan kawalan kelajuan yang pelbagai
变速控制

Standard Equipment: Abrasive Paper, Dust Bag



Continuous Rating Input Input Kuasa Berterusan 额定输入功率	300W
Pad Diameter Saiz Pad 垫大小	123mm (4-7/8")
Abrasive Disc Size Saiz Cakera 磨盘尺寸	125mm (5")
Orbits Per Minute (OPM) Bilangan Putaran 轨道转速	4,000-12,000
Dimensions (L x W x H) Dimensi 体积	153x123x153mm (6"x4-7/8"x6")
Net Weight Berat Bersih 净重	1.3kg (3lbs)
Power Supply Cord Kabel Wayar 电源线	2.0m (6.6ft)

BO5041

64

Random Orbit Sander Pengampelas 砂光机



- More power for faster sanding and
a smooth finish
Lebih berkuasa untuk pelicinan cepat dan lancar
更快速的打磨

Standard Equipment: Abrasive Paper, Dust Bag



Continuous Rating Input Input Kuasa Berterusan 额定输入功率	300W
Pad Diameter Saiz Pad 垫大小	123mm (4-7/8")
Abrasive Disc Size Saiz Cakera 磨盘尺寸	125mm (5")
Orbits Per Minute (OPM) Bilangan Putaran 轨道转速	4,000-12,000
Dimensions (L x W x H) Dimensi 体积	218x123x153mm (8-5/8"x4-7/8"x6")
Net Weight Berat Bersih 净重	1.4kg (3.1lbs)
Power Supply Cord Kabel Wayar 电源线	2.0m (6.6ft)

Cordless
Tanpa Kabel 无线式LED Flashlight
Lampu Suhu LED
LED照明灯Vacuum Cleaner
Penjimat Vakuum
吸尘器Drilling / Fastening
Gergaji / Pengikat
钻床 / 夹具Impact Drilling / Demolition
Gergaji / Pemusnah
冲击钻 / 破拆工具Cutting / Finishing
Pemotong / Finishing
切割 / 打磨Grinding / Sanding
Pengamiran / Pasir
磨削 / 打磨Sawing
Gergaji
锯切Planing / Routing
Penghalus / Tenggang
刨平 / 铣削Others
Lain-lain
其他Outdoor Power Equipment
Alatan Kerja Luar
户外动力设备Makita
19111

SAWING

Gergaji 锯切



LS1019L 260mm (10-1/4")

153 W

Slide Compound Miter Saw

Gergaji Komaun Miter
斜断锯



- **Large turn base supports workpiece securely for increased stability**
Dasar besar untuk menyokong bahan kerja dengan stabil
大转动底座稳定地支撑工件

Standard Equipment: EFFICUT Saw Blade, Dust Bag, Triangular Rule, Vertical Vise, Hex Wrench



Continuous Rating Input Input Kuasa Berterusan 额定输入功率	1,510W
Blade Diameter Diameter Bilah 锯片直径	260mm (10-1/4")
Bevel Angle Sudut Bevel 斜角	48°L/ 48°R
Miter Angle Sudut Miter 斜接角	60°L/ 60°R
Max Cutting Capacity Kapasiti Pemotongan Maksimum 最大切割能力	Crown Molding Vertically Nested: 168mm (6-5/8") Crown Molding Lying Flat: 248mm (9-3/4") Base Board Against Fence: 133mm (5-1/4") Base Board Lying Flat: 305mm (12")
No Load Speed (RPM) Kelajuan Tanpa Beban 回转数	3,200
Dimensions (L x W x H) Dimensi 体积	805x644x660mm (31-3/4"x25-3/8"x26")
Net Weight Berat Bersih 净重	26.3kg (57.9lbs.)
Power Supply Cord Kabel Wayar 电源线	2.5m (8.2ft.)

LS1219L 305mm (12")

153 W

Slide Compound Miter Saw

Gergaji Komaun Miter
斜断锯



- **Dual dust collection ports provide excellent dust extraction performance**
Dua pengumpul habuk untuk prestasi pengekstrakan habuk yang sangat baik
双重集尘口提供出色的除尘性能

Standard Equipment: TCT Saw Blade (B-67474), Vertical Vise, Hex Wrench, Triangular Rule, Dust Bag



Continuous Rating Input Input Kuasa Berterusan 额定输入功率	1,800W
Blade Diameter Diameter Bilah 锯片直径	305mm (12")
Hole Diameter Diameter Lubang 孔直径	European Countries: 30mm (1-3/16") Others: 25.4mm (1")
Angle Sudut 角度	Bevel 48° L / 48° R Miter 60° L / 60° R
Max Cutting Capacity Kapasiti Pemotongan Maksimum 最大切割能力	Crown Molding Vertically Nested: 203mm (8") Crown Molding Lying Flat: 320mm (12-5/8") Base Board Against Fence: 171mm (6-3/4") Base Board Lying Flat: 416mm (16-3/8")
No Load Speed (RPM) Kelajuan Tanpa Beban 回转数	3,200
Dimensions (L x W x H) Dimensi 体积	898x664x725mm (35-1/4"x26-1/8"x28-1/2")
Net Weight Berat Bersih 净重	29.5kg (65.0lbs)
Power Supply Cord Kabel Wayar 电源线	2.5m (8.2ft)

LS1018L 260mm (10-1/4")

Slide Compound Saw

Gergaji Komaun Miter
斜断锯



- **Large cutting capacity in a compact design and less weight**
Kapasiti pemotongan besar dalam reka bentuk kompak dan ringan
设计紧凑, 轻量, 切割能力大

Standard Equipment: TCT Saw Blade (B-14277), Vertical Vise, Socket Wrench, Triangular Rule, Dust Bag, Holder assembly



Continuous Rating Input Input Kuasa Berterusan 额定输入功率	1,430W
Blade Diameter Diameter Bilah 锯片直径	255 - 260mm (10 - 10-1/4")
Miter Angle Sudut Miter 斜接角	47°L/ 60°R
Bevel Angle Sudut Bevel 斜角	45°L/ 45°R
Max Cutting Capacity Kapasiti Pemotongan Maksimum 最大切割能力	90°: 91 x 305mm (3-5/8" x 12") 45°: 91 x 215mm (3-5/8" x 8-1/2")
No Load Speed (RPM) Kelajuan Tanpa Beban 回转数	4,300
Dimensions (L x W x H) Dimensi 体积	825x536x633mm (32-1/2"x21-1/8"x25")
Net Weight Berat Bersih 净重	20.6kg (45.4lbs)
Power Supply Cord Kabel Wayar 电源线	2.5m (8.2ft)

LS1040 260mm (10-1/4")

153 W

Compound Miter Saw

Gergaji Komaun Miter
斜断锯



- **Powerful 1,650W direct drive motor for improved performance**
Motor 1,650W yang berkuasa meningkatkan prestasi
功率强劲的1,650W直驱马达提高了性能

Standard Equipment: Socket Wrench, Dust Bag, Holder Set, Vertical Vise, Triangular Rule



Continuous Rating Input Input Kuasa Berterusan 额定输入功率	1,650W
Blade Diameter Diameter Bilah 锯片直径	260mm (10-1/4")
Miter Angle Sudut Miter 斜接角	45°L/ 52°R
Bevel Angle Sudut Bevel 斜角	45°L
Max Cutting Capacity Kapasiti Pemotongan Maksimum 最大切割能力	90°: 90.5 x 95mm (3-9/16" x 3-3/4") 45°: 90.5 x 67mm (3-9/16" x 2-5/8")
No Load Speed (RPM) Kelajuan Tanpa Beban 回转数	4,600
Dimensions (L x W x H) Dimensi 体积	530x476x532mm (20-7/8"x18-3/8"x21")
Net Weight Berat Bersih 净重	12.4kg (27.3lbs)
Power Supply Cord Kabel Wayar 电源线	2.5m (8.2ft)

Cordless
Tangan Rendah Volt

LED Flashlight
Lampu Cahaya LED
LEDORNIPT

Vacuum Cleaner
Penyedut Vakuum
真空吸尘器

Drilling / Fastening
Gergaji / Penutup
钻孔 / 紧固

Impact Drilling / Demolition
Gergaji / Pemusnah
冲击钻孔 / 拆除工具

Cutting / Finishing
Memotong / Menyelesaikan
切割 / 收口

Grinding / Sanding
Pengamiran / Halus
磨削 / 打磨

Sawing / Routing
Gergaji / Mengalir
锯切 / 导槽

Others
Lain-lain
其他

Outdoor Power Equipment
Araian Kuasa Luar
户外动力设备

Makita
MAKITA

SAWING

LS0714 190mm (7-1/2") 153

Slide Compound Saw
Gergaji Kompaun Miter
斜断锯



- Compact and Lightweight for Increased Jobsite Portability
Kompak dan Ringan
小巧轻便

Standard Equipment: Carbide-Tipped Saw Blade, Dust Bag, Holder Set, Vertical Vise, Triangular Rule



Continuous Rating Input Input Kuasa Berterusan 额定输入功率	1,010W
Blade Diameter Diameter Bilah 锯片直径	190mm (7-1/2")
Miter Angle Sudut Miter 斜接角	47°L / 57°R
Bevel Angle Sudut Bevel 斜角	45°L / 5°R
Max Cutting Capacity Kapasiti Pemotongan Maksimum 最大切割能力	90°: 52 x 300mm (2-1/16" x 11-3/4") 45°: 52 x 212mm (2-1/16" x 8-3/8")
No Load Speed (RPM) Kelajuan Tanpa Beban 回转数	6,000
Dimensions (L x W x H) Dimensi 体积	670x430x458mm (26-3/8"x17"x18")
Net Weight Berat Bersih 净重	13.1kg (28.9lbs)
Power Supply Cord Kabel Wayar 电源线	2.5m (8.2ft)

LS1440 355mm (14") 153

Miter Saw
Gergaji Miter
斜断锯



- Large cutting capacity
Kapasiti pemotongan besar
大切割能力

Standard Equipment: Socket Wrench, Vise Assembly, Dust Bag, Holder Set



Continuous Rating Input Input Kuasa Berterusan 额定输入功率	1,380W
Max Cutting Capacity Kapasiti Pemotongan Maksimum 最大切割能力	90°: 122 x 152mm (4-13/16" x 6") 45°: 122 x 115mm (4-13/16" x 4-1/2")
Blade Diameter Diameter Bilah 锯片直径	355mm (14")
No Load Speed (RPM) Kelajuan Tanpa Beban 回转数	3,200
Dimensions (L x W x H) Dimensi 体积	530x596x435mm (20-7/8"x23-1/2"x17-1/8")
Net Weight Berat Bersih 净重	34.2kg (75.4lbs)
Power Supply Cord Kabel Wayar 电源线	2.5m (8.2ft)

MAXIMUM CUTTING CAPACITY

Kapasiti Pemotongan Maksimum 最大切割能力

Model No.	Base Angle	Blade Angle Left 45°	Blade Angle 0°	Blade Angle Right 5°	Blade Angle Right 45°
LS0714	0°	40x300mm	52x300mm	40x300mm	-
	Left / Right 45°	40x212mm	52x212mm	-	-
	-	-	-	-	-
	Right 57°	-	52x163mm	-	-
LS1018L	0°	50x305mm	91x305mm	-	31x305mm
	Left / Right 45°	50x215mm	91x215mm	-	31x215mm
	-	-	-	-	-
	Right 60°	-	91x150mm	-	-
LS1019L	0°	47x305, 61x279mm	71x305, 91x279mm	-	29x305, 43x279mm
	Left / Right 45°	47x215, 61x197mm	71x215, 91x197mm	-	29x215, 43x197mm
	Left / Right 60°	-	71x152, 91x139mm	-	-
	-	-	-	-	-
LS1219L	0°	71x363mm	107x363mm	-	54x363mm
	Left / Right 45°	71x255mm	107x255mm	-	54x255mm
	Left / Right 60°	-	107x178mm	-	-
	-	-	-	-	-
LS1040	0°	48x95mm	90.5x95mm	-	-
	Left / Right 45°	48x67mm	90.5x67mm	-	-
	-	-	-	-	-
	-	-	-	-	-
LH1201FL	0°	64x155mm	95x155mm	-	-
	Left 45°	64x65mm	95x110mm	-	-
	Right 45°	40x125mm	95x110mm	-	-
	Cutting capacity as table saw: 52mm				

LH1201FL 305mm (12")

Table Top Miter Saw
Gergaji Miter
两用平台斜切锯



- 2 tools in 1 for convenience and versatility
Alat 2 dalam 1
1机2用

Standard Equipment: TCT Saw Blade, Vertical Vise, Dust Bag, Rip Fence, Ring, Triangular Rule, Push Stick, Blade Cover, Socket Wrench, Holder Set



Continuous Rating Input Input Kuasa Berterusan 额定输入功率	1,650W
Blade Diameter Diameter Bilah 锯片直径	305mm (12")
Miter Angle Sudut Miter 斜接角	47°L / 52°R
Bevel Angle Sudut Bevel 斜角	45°L
Max Cutting Capacity Kapasiti Pemotongan Maksimum 最大切割能力	90°: 62 x 200mm (2-7/16" x 7-7/8") / 90°: 95 x 155mm (3-3/4" x 6-1/8") / 45° Miter, L/R: 62 x 135mm (2-7/16" x 5-5/16") / 45° Miter, L/R: 95 x 110mm (3-3/4" x 4-5/16") / 90°, Table saw: 52mm (2-1/16")
No Load Speed (RPM) Kelajuan Tanpa Beban 回转数	3,800
Dimensions (L x W x H) Dimensi 体积	610x535x692mm (24"x21"x27-1/4") Table Size (W x L): 307 x 465mm (12-1/8" x 18-1/4")
Net Weight Berat Bersih 净重	20.9kg (46.1lbs)
Power Supply Cord Kabel Wayar 电源线	2.5m (8.2ft)

Cordless
Tempa Alat 无线

 LED Flashlight
Lampu Flash LED
LAMPU BINTANG

 Vacuum Cleaner
Penyedut Debu
VACUUM

 Drilling / Filing
Gergaji / Pengkilat
BORING / FILE

 Impact Drilling / Demolition
Gergaji / Penanggal
BORING / HANCURKAN

 Cutting
Pemotongan
CUTTING

 Grinding / Sanding
Pengkilat / Hancur
GRINDING / SANDING

 Sawing
Gergaji
SAWING

 Planing / Routing
Pengkilat / Tangkapan
PLANING / ROUTING

 Others
Lain-lain
LAIN-LAIN

 Outdoor Power Equipment
Alat-alat Kejuruteraan
ALAT-ALAT

Makita
— THE 1 —

SAWING

Cordless
Tanpa Kabel Listrik

LED Flashlight
Lampu Senter LED
LCO-001017

Vacuum Cleaner
Pembersih Vakum

Drilling / Fastening
Gergaji / Pengikat

Impact Drilling / Demolition
Gergaji / Pemecah

Cutting
Memotong

Grinding / Sanding
Pengamiran / Haluskan

Sawing / Routing
Gergaji / Renggang

Others
Lain-lain

Outdoor Power Equipment
Alat-alat Tenaga Luar

Makita
T.M.T.

LF1000 260mm (10-1/4")

153

Flip Over Saw

Gergaji Flip
翻转锯



- **Quick miter saw/ table saw conversion**
Konversi gergaji miter & gergaji meja
斜割锯及台锯快速转换

Standard Equipment: Rip Fence, Miter Gauge, Push Stick, Top Cover Assy (Top Blade Guard), Dust Cover, Dust Bag, Wrench 8



Continuous Rating Input Input Kuasa Berterusan 额定输入功率	1,650W
Max Cutting Capacity Kapasiti Pemotongan Maksimum 最大切割能力	90°: 20 x 210mm (13/16" x 8-1/4") 90°: 68 x 155mm (2-11/16" x 6-1/8") 45°: 50 x 150mm (2" x 5-7/8")
Blade Diameter Diameter Bilah 锯片直径	260mm (10-1/4")
No Load Speed (RPM) Kelajuan Tanpa Beban 回转速数	2,700
Dimensions (L x W x H) Dimensi 体积	Miter saw : 660x650x1,220mm (26"x25-1/2"x48") Table saw : 660x650x1,060mm (26"x25-1/2"x41-3/4")
Net Weight Berat Bersih 净重	36.0 kg (79.4 lbs)
Power Supply Cord Kabel Wayar 电源线	2.5 m (8.2 ft)

2704 260mm (10-1/4")

153

Table Saw

Gergaji Meja
台锯



- **Electric brake for increased productivity and operator safety**
Brek Elektrik untuk peningkatan produktiviti dan pengendali keselamatan
电子自动刹车提高生产率和操作安全

Standard Equipment: Carbide-Tipped Saw Blade (B-17734), Rip Fence, Miter Gauge, Wrenches, Push Stick, Ring



Continuous Rating Input Input Kuasa Berterusan 额定输入功率	1,650W
Max Cutting Capacity Kapasiti Pemotongan Maksimum 最大切割能力	90°: 93mm (3-5/8") 45°: 64mm (2-1/2")
Blade Diameter Diameter Bilah 锯片直径	260mm (10-1/4")
No Load Speed (RPM) Kelajuan Tanpa Beban 回转速数	4,800
Dimensions (L x W x H) Dimensi 体积	665x766x344mm (26-1/4"x30-1/4"x13-1/2")
Net Weight Berat Bersih 净重	35.6 - 37.3kg (78.5 - 82.3lbs.)
Power Supply Cord Kabel Wayar 电源线	2.5m (8.2ft)

MLT100 260mm (10-1/4")

Table Saw

Gergaji Meja
台锯



- **Right and rear extension table enables greater cutting capacity**
Meja tambahan kanan dan belakang membolehkan kapasiti pemotongan yang lebih besar
右侧和后侧延伸台具有更大的切割能力

Standard Equipment: Carbide-Tipped Saw Blade, Rip Fence, Miter Gauge, Wrenches, Push Stick, Triangular Rule



Continuous rating input Input Kuasa Berterusan 额定输入功率	1,500W
Max Cutting Capacity Kapasiti Pemotongan Maksimum 最大切割能力	90°: 91mm (3-9/16") 45°: 63mm (2-1/2")
Blade Diameter Diameter Bilah 锯片直径	260mm (10-1/4")
No Load Speed (RPM) Kelajuan Tanpa Beban 回转速数	4,300
Dimensions (L x W x H) Dimensi 体积	726x984x333mm (28-1/2"x38-3/4"x13-1/8")
Net weight Berat Bersih 净重	34.1kg (75.2lbs)
Power supply cord Kabel Wayar 电源线	2.5m (8.2ft)

2712 315mm (12-3/8")

Table Saw

Gergaji Meja
台锯



- **Powerful 2,000W motor for fast cutting**
Motor berkuasa 2,000W untuk pemotongan pantas
功能强大的2,000W马达快速切割

Standard Equipment: Carbide-Tipped Saw Blade, Rip Fence, Miter Gauge, Wrenches, Push Stick, Ring



Max Cutting Capacity Kapasiti Pemotongan Maksimum 最大切割能力	90°: 85mm (3-3/8") 45°: 58mm (2-1/4")
Blade Diameter Diameter Bilah 锯片直径	315mm (12-3/8")
No Load Speed (RPM) Kelajuan Tanpa Beban 回转速数	50Hz: 2,950 60Hz: 3,400
Bevel Capacity Kapasiti Bevel 斜角容量	0° - 45°
Dimensions (L x W x H) Dimensi 体积	1,670x700x810mm (65-3/4"x27-1/2"x32")
Net weight Berat Bersih 净重	54kg (118.9lbs)
Power supply cord Kabel Wayar 电源线	3.0m (9.8ft)

HS6100 165mm (6-1/2")

174

Circular Saw

Gergaji Piring
圆锯



- **Smooth cutting at high rotational speed**
Pemotongan licin pada kelajuan putaran tinggi
在高转速下平滑切割

Standard Equipment: Carbide-Tipped Saw Blade (B-02917), Hex Wrench, Rip Fence (Guide Rule), Dust Nozzle (195801-0)



Continuous Rating Input Input Kuasa Berterusan 额定输入功率	1,100W
Blade Diameter Diameter Bilah 锯片直径	165mm (6-1/2")
Max Cutting Capacity Kapasiti Pemotongan Maksimum 最大切割能力	90°: 54.5mm (2-1/8")/ 45°: 39.5mm (1-9/16")/ 50°: 35.5mm (1-3/8")
No Load Speed (RPM) Kelajuan Tanpa Beban 回转速数	5,500
Dimensions (L x W x H) Dimensi 体积	297x246x246mm (11-3/4"x9-11/16"x9-11/16")
Net Weight Berat Bersih 净重	3.5kg (7.7lbs)
Power Supply Cord Kabel Wayar 电源线	2.5m (8.2ft)

SAWING

HS6600 165mm (6-1/2")

303

Circular Saw Gergaji Piring 圆锯



- **More compact and lightweight design**
Reka bentuk lebih padat dan ringan
更小巧轻便的设计

Standard Equipment: Rip Fence (Guide Rule),
TCT Saw Blade (B-02917), Hex Wrench



Continuous Rating Input Input Kuasa Berterusan 额定输入功率	1,050W
Blade Diameter Diameter Bilah 锯片直径	165mm (6-1/2")
Max Cutting Capacity Kapasiti Pemotongan Maksimum 最大切割能力	90°: 54.5mm (2-1/8") 45°: 37.5mm (1-1/2")
No Load Speed (RPM) Kelajuan Tanpa Beban 回转数	5,200
Dimensions (L x W x H) Dimensi 体积	296x230x243mm (11-5/8"x9"x9-9/16")
Net Weight Berat Bersih 净重	3.5kg (7.6lbs)
Power Supply Cord Kabel Wayar 电源线	2.5m (8.2ft)

HS7010 185mm (7-1/4") / 190mm (7-1/2")

Circular Saw Gergaji Piring 圆锯



- **High Power and Increased Motor-Burnout Resistance**
Berkuasa Tinggi
高功率

Standard Equipment: TCT Saw Blade, Rip Fence (Guide Rule),
Hex Wrench



Continuous Rating Input Input Kuasa Berterusan 额定输入功率	1,600W
Blade Diameter Diameter Bilah 锯片直径	185/ 190mm (7-1/4"/ 7-1/2")
Max Cutting Capacity Kapasiti Pemotongan Maksimum 最大切割能力	90°: 65/ 67mm (2-9/16"/ 2-5/8") 45°: 44/ 45mm (1-3/4"/ 1-3/4")
No Load Speed (RPM) Kelajuan Tanpa Beban 回转数	5,500
Dimensions (L x W x H) Dimensi 体积	300x240x261mm (11-3/4"x9-1/2"x10-1/4")
Net Weight Berat Bersih 净重	4.0kg (8.9lbs)
Power Supply Cord Kabel Wayar 电源线	2.5m (8.2ft)

HS7600 185mm (7-1/4")

303

Circular Saw Gergaji Piring 圆锯



- **Powerful 1,200W motor**
Motor berkuasa 1,200W
强力1,200W马达

Standard Equipment: TCT Saw Blade, Rip Fence (Guide Rule),
Hex Wrench



Continuous Rating Input Input Kuasa Berterusan 额定输入功率	1,200W
Blade Diameter Diameter Bilah 锯片直径	185mm (7-1/4")
Max Cutting Capacity Kapasiti Pemotongan Maksimum 最大切割能力	90°: 64mm (2-1/2") 45°: 42mm (1-5/8")
No Load Speed (RPM) Kelajuan Tanpa Beban 回转数	5,200
Dimensions (L x W x H) Dimensi 体积	309x234x255mm (12-1/8"x9-1/4"x10")
Net Weight Berat Bersih 净重	3.8kg (8.3lbs)
Power Supply Cord Kabel Wayar 电源线	2.5m (8.2ft)

5806B 185mm (7-1/4")

303

Circular Saw Gergaji Piring 圆锯



- **Powerful motor for smooth operation even in heavy duty cutting**
Motor berkuasa untuk operasi lancar walaupun dalam pemotongan tugas berat
强大的马达即使在重型切割中也可以平稳运行

Standard Equipment: Carbide-Tipped Saw Blade, Hex Wrench,
Rip Fence (Guide Rule)



Continuous Rating Input Input Kuasa Berterusan 额定输入功率	1,050W
Blade Diameter Diameter Bilah 锯片直径	185mm (7-1/4")
Max Cutting Capacity Kapasiti Pemotongan Maksimum 最大切割能力	90°: 66mm (2-5/8") 45°: 44mm (1-11/16")
No Load Speed (RPM) Kelajuan Tanpa Beban 回转数	5,200
Overall Length Panjang Keseluruhan 总长度	282mm (11-1/8")
Net Weight Berat Bersih 净重	3.5kg (7.6lbs)
Power Supply Cord Kabel Wayar 电源线	2.5m (8.2ft)

5008MG 210mm (8-1/4")

153

Circular Saw Gergaji Piring 圆锯



- **Powerful 1,800W motor for proven performance**
Motor berkuasa 1,800W untuk prestasi yang terbukti
功率强大的1,800W马达，性能可靠

Standard Equipment: TCT Saw Blade (D-29066), Hex Wrench,
Rip Fence (Guide Rule)



Continuous Rating Input Input Kuasa Berterusan 额定输入功率	1,800W
Blade Diameter Diameter Bilah 锯片直径	210mm (8-1/4")
Max Cutting Capacity Kapasiti Pemotongan Maksimum 最大切割能力	90°: 75.5mm (3") 45°: 57mm (2-1/4") 50°: 51.5mm (2")
No Load Speed (RPM) Kelajuan Tanpa Beban 回转数	5,200
Dimensions (L x W x H) Dimensi 体积	332x243x277mm (13-1/8"x9-9/16"x10-7/8")
Net Weight Berat Bersih 净重	4.8kg (10.6lbs)
Power Supply Cord Kabel Wayar 电源线	2.5m (8.2ft)

Cordless
Tempa Alat Berita

LED Flashlight
Lampu Suluh LED
LEDPADAMBIT

Vacuum Cleaner
Penyedut Vakuam
VACUUM

Drilling / Filing
Gergaji / Pengkilat
METS / 美特

Impact Drilling / Demolition
Gergaji / Penekap
IMPACT / 冲击钻

Cutting
Pemotongan
CUTTING

Grinding / Sanding
Pengkilat / Pengkilat
GRINDING / 磨

Sawing
Gergaji
SAWING

Planing / Routing
Polishing / Tangan
PLANING / 刨

Others
Lain-lain
OTHERS

Outdoor Power Equipment
Alat Kuasa Luar
OUTDOOR POWER EQUIPMENT

Makita
MITSUBISHI

SAWING

Cordless
Tanpa Kabel Listrik

LED Flashlight
Lampu Flash LED

Vacuum Cleaner
Penyedot Vakum

Drilling / Fastening
Gergaji / Penutup

Impact Drilling / Demolition
Gergaji / Pemecah

Cutting
Pemotongan

Grinding / Sanding
Pengamiran / Pengamiran

Sawing
Gergaji

Planing / Routing
Pengamiran / Pengamiran

Others
Lain-lain

Outdoor Power Equipment
Alat-alat Listrik Luar Ruangan

Makita
Makita

N5900B 235mm (9-1/4")

153 WATT

Circular Saw

Gergaji Piring
圓鋸



- **High power 2,000W to rip through most materials**
Kuasai tinggi 2,000W untuk pemotongan pelbagai bahan
大功率2000W可以切割大部分材料

Standard Equipment: Carbide-Tipped Saw Blade,
Rip Fence (Guide Rule), Wrench 13



Continuous Rating Input Input Kuasa Berterusan 额定输入功率	2,000W
Max Cutting Capacity Kapasiti Pemotongan Maksimum 最大切割能力	90°: 85mm (3-3/8") 45°: 60mm (2-3/8") 50°: 53mm (2-1/16")
Blade Diameter Diameter Bilah 锯片直径	235mm (9-1/4")
No Load Speed (RPM) Kelajuan Tanpa Beban 回转数	4,100
Overall Length Panjang Keseluruhan 总长度	380mm (15")
Net Weight Berat Bersih 淨重	6.8kg (14.8lbs)
Power Supply Cord Kabel Wayar 电源线	2.5m (8.2ft)

HS0600 260mm (10-1/4")/ 270mm (10-5/8")

153 WATT

Circular Saw

Gergaji Piring
圓鋸



- **Powerful 2,100W motor**
Motor berkuasa 2,100W
強力2,100W马达

Standard Equipment: TCT Saw Blade, Rip Fence (Guide Rule),
Hex Wrench



Continuous Rating Input Input Kuasa Berterusan 额定输入功率	2,000W
Blade Diameter Diameter Bilah 锯片直径	260/ 270mm (10-1/4" / 10-5/8")
Max Cutting Capacity Kapasiti Pemotongan Maksimum 最大切割能力	90°: 97/ 101mm (3-13/16" / 4") 45°: 68/ 71mm (2-11/16" / 2-13/16") 50°: 61/ 63mm (2-3/8" / 2-1/2")
No Load Speed (RPM) Kelajuan Tanpa Beban 回转数	4,300
Dimensions (L x W x H) Dimensi 体积	418x273x324mm (16-1/2"x10-3/4"x12-3/4")
Net Weight Berat Bersih 淨重	6.9kg (15.2lbs)
Power Supply Cord Kabel Wayar 电源线	2.5m (8.2ft)

5103N 335mm (13-1/8")

153 WATT

Circular Saw

Gergaji Piring
圓鋸



- **Smooth cutting at high rotational speed**
Pemotongan licin pada kelajuan putaran tinggi
在高转速下平滑切割

Standard Equipment: Wrench, Rip Fence (Guide Rule)

Continuous Rating Input Input Kuasa Berterusan 额定输入功率	1,750W
Blade Diameter Diameter Bilah 锯片直径	335mm (13-1/8")
Max Cutting Capacity Kapasiti Pemotongan Maksimum 最大切割能力	90°: 128mm (5") 45°: 91mm (3-5/8")
No Load Speed (RPM) Kelajuan Tanpa Beban 回转数	2,900
Overall Length Panjang Keseluruhan 总长度	505mm (19-7/8")
Net Weight Berat Bersih 淨重	8.9kg (19.6lbs)
Power Supply Cord Kabel Wayar 电源线	5.0m (16.4ft)

5402 415mm (16-5/16")

153 WATT

Circular Saw

Gergaji Piring
圓鋸



- **Smooth cutting at high rotational speed**
Pemotongan licin pada kelajuan putaran tinggi
在高转速下平滑切割

Standard Equipment: Combination Saw Blade, Hex Wrench,
Rip Fence (Guide Rule)

Blade Diameter Diameter Bilah 锯片直径	415mm (16-5/16")
Max Cutting Capacity Kapasiti Pemotongan Maksimum 最大切割能力	90°: 157mm (6-3/16") 45°: 106mm (4-3/16")
No Load Speed (RPM) Kelajuan Tanpa Beban 回转数	2,200
Overall Length Panjang Keseluruhan 总长度	615mm (24-1/4")
Net Weight Berat Bersih 淨重	12.9kg (28.4lbs)
Power Supply Cord Kabel Wayar 电源线	5.0m (16.4ft)

SP6000J 165mm (6-1/2")

303 WATT

Plunge Cut Circular Saw

Gergaji Piring
圓鋸



- **Built-in current limiter helps prevent motor burnout**
Pengehad arus terbina dalam mencegah motor dari terbakar
电流限制器有助于防止马达烧毁

Standard Equipment: TCT Saw Blade (B-07353), Hex Wrench

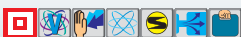

Continuous Rating Input Input Kuasa Berterusan 额定输入功率	1,300W
Blade Diameter Diameter Bilah 锯片直径	165mm (6-1/2")
Max Cutting Capacity Kapasiti Pemotongan Maksimum 最大切割能力	90°: 56mm (2-3/16") 45°: 40mm (1-9/16") 48°: 38mm (1-1/2")
No Load Speed (RPM) Kelajuan Tanpa Beban 回转数	2,000 - 5,800
Dimensions (L x W x H) Dimensi 体积	341x225x250mm (13-3/8"x8-7/8"x9-7/8")
Net Weight Berat Bersih 淨重	4.1kg (9lbs)
Power Supply Cord Kabel Wayar 电源线	2.5m (8.2ft)

SAWING



4329

Jig Saw

Gergaji Jig
线锯机



- **Bevel cuts to 45° right or left and positive stop at 90° for solid cutting performance**
Kelajuan tinggi dan kecekapan tinggi
高速与高效率



Continuous Rating Input Input Kuasa Berterusan 额定输入功率	450W
Max Cutting Capacity at 90° Kapasti Pemotongan Maksimum 最大切割能力	Wood: 65 mm (2-9/16") Steel: 6 mm (1/4")
Length of Stroke Panjang Strok 冲程长度	18 mm (11/16")
Strokes Per Minute (SPM) Kelajuan Strok 冲程速度	500 - 3,100
Dimensions (L x W x H) Dimensi 体积	223x77x197mm (8-3/4"x3"x7-3/4")
Net Weight Berat Bersih 净重	1.9kg (4.2lbs.)
Power Supply Cord Kabel Wayar 电源线	2.0m (6.6ft)

Standard Equipment: Jig Saw Blade (B-10), Hex Wrench



4350CT

Jig Saw

Gergaji Jig
线锯机



- **3 orbital settings plus straight cutting with a powerful 720W motor**
3 tetapan orbital serta pemotongan lurus dengan motor berkuasa 720W
强大的720W马达, 3个轨道设置与直切割



Continuous Rating Input Input Kuasa Berterusan 额定输入功率	720W
Capacity Kapasti 能力	Wood: 135mm (5-5/16") Steel: 10mm (3/8")
Length of Stroke Panjang Strok 冲程长度	26mm (1")
Strokes Per Minute (SPM) Kelajuan Strok 冲程速度	800 - 2,800
Dimensions (L x W x H) Dimensi 体积	236x73x207mm (9-1/4"x 2-7/8"x 8-1/8")
Net Weight Berat Bersih 净重	2.7kg (5.8lbs)
Power Supply Cord Kabel Wayar 电源线	2.5m (8.2ft)

Standard Equipment: Hex Wrench, Cover Plate, Anti-Splintering Device, Jig Saw Blade Set (No. B-10, BR-13, B-22, 2pcs each)



4351CT

Jig Saw

Gergaji Jig
线锯机



- **Bevel cuts to 45° right or left and positive stop at 90° for solid cutting performance**
Potongan serong ke 45° kanan atau kiri dan berhenti positif pada 90° untuk prestasi pemotongan pepejal
斜面切割45°左右, 90°正向切割, 切削性能稳定



Continuous Rating Input Input Kuasa Berterusan 额定输入功率	720W
Capacity Kapasti 能力	Wood: 135mm (5-5/16") Steel: 10mm (3/8")
Length of Stroke Panjang Strok 冲程长度	26 mm (1")
Strokes Per Minute (SPM) Kelajuan Strok 冲程速度	800 - 2,800
Dimensions (L x W x H) Dimensi 体积	271x73x187mm (10-11/16"x 2-7/8"x 7-3/8")
Net Weight Berat Bersih 净重	2.6kg (5.7lbs)
Power Supply Cord Kabel Wayar 电源线	2.5m (8.2ft)

Standard Equipment: Hex Wrench, Cover Plate, Anti-Splintering Device, Jig Saw Blade Set (No. B-10, BR-13, B-22, 2pcs each)



JV600K

Jig Saw

Gergaji Jig
线锯机



- **Toolless blade change system for fast blade installation and removal**
Penukaran bilah tanpa alat untuk pemasangan bilah cepat
无需工具更换刀片, 可快速安装和拆卸刀片



Continuous Rating Input Input Kuasa Berterusan 额定输入功率	650W
Capacity Kapasti 能力	Wood: 90mm (3-1/2") Steel: 10mm (3/8")
Length of Stroke Panjang Strok 冲程长度	23mm (7/8")
Strokes Per Minute (SPM) Kelajuan Strok 冲程速度	500 - 3,100
Dimensions (L x W x H) Dimensi 体积	236x77x199mm (9-1/4"x3"x7-7/8")
Net Weight Berat Bersih 净重	2.4kg (5.3lbs)
Power Supply Cord Kabel Wayar 电源线	2.5m (8.2ft)

Standard Equipment: Jig Saw Blade, Hex Wrench



Cordless
Tempa Alat 无线

LED Flashlight
Lampu Suka LED
LED光源

Vacuum Cleaner
Penyedut Vakuam
吸尘器

Drilling / Filing
Gergaji / Pengkilat
电钻 / 电磨

Impact Drilling / Demolition
Gergaji / Pemukul
电钻 / 电锤

Cutting
Pemotong
切割

Grinding / Sanding
Pengkilat / Gergaji
电磨 / 电锯

Sawing
Gergaji
锯切

Planing / Routing
Polir / Tangkapan
刨平 / 刨花

Others
Lain-lain
其他

Outdoor Power Equipment
Alat Kuasa Luar
户外动力设备

Makita
Makita

SAWING

4327M

64

Jig Saw

Gergaji Jig
线锯机



- **High power and Lightweight**
Kuasai tinggi dan Ringan
高功率和轻量

Standard Equipment: Jig Saw Blade, Hex Wrench



Continuous Rating Input Input Kuasa Berterusan 额定输入功率	450W
Capacity Kapasiti 能力	Wood: 40mm (1-9/16") Steel: 6mm (1/4")
Length of Stroke Panjang Strok 冲程长度	18mm (11/16")
Strokes Per Minute (SPM) Kelajuan Strok 冲程速度	500 - 3,100
Dimensions (L x W x H) Dimensi 体积	224x77x197mm (8-7/8"x3"x7-3/4")
Net Weight Berat Bersih 净重	1.8kg (4.0lbs)
Power Supply Cord Kabel Wayar 电源线	2.0m (6.6ft)

4327

64

Jig Saw

Gergaji Jig
线锯机



- **High power and Lightweight**
Kuasai tinggi dan Ringan
高功率和轻量

Standard Equipment: Jig Saw Blade, Hex Wrench



Continuous Rating Input Input Kuasa Berterusan 额定输入功率	450W
Capacity Kapasiti 能力	Wood: 65mm (2-9/16") Steel: 6mm (1/4")
Length of Stroke Panjang Strok 冲程长度	18mm (11/16")
Strokes Per Minute (SPM) Kelajuan Strok 冲程速度	500 - 3,100
Dimensions (L x W x H) Dimensi 体积	224x77x197mm (8-7/8"x3"x7-3/4")
Net Weight Berat Bersih 净重	1.9kg (4.2lbs)
Power Supply Cord Kabel Wayar 电源线	2.0m (6.6ft)

4300BV

51

Jig Saw

Gergaji Jig
线锯机



- **Robust construction and strength to cut through a wide range of materials**
Pembinaan yang kukuh dengan kekuatan untuk memotong pelbagai bahan
坚固的结构和强度可切割各种材料

Standard Equipment: Jig saw blade set, Rip Fence (Guide Rule), Circular Guide, Hex Wrench



Continuous Rating Input Input Kuasa Berterusan 额定输入功率	390W
Capacity Kapasiti 能力	Wood: 55mm (2-1/8") Steel: 6mm (1/4")
Length of Stroke Panjang Strok 冲程长度	26mm (1")
Strokes Per Minute (SPM) Kelajuan Strok 冲程速度	0-3,100
Overall Length Panjang Keseluruhan 总长度	225mm (8-7/8")
Net Weight Berat Bersih 净重	2.5kg (5.5lbs)
Power Supply Cord Kabel Wayar 电源线	2.5m (8.2ft)

JR3050T

303

Recipro Saw

Gergaji Resipro
往复锯

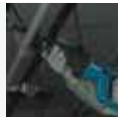

- **Ideal for framers, carpenters, electricians, plumbers and general construction**
Untuk framers, tukang kayu, juruelektrik, tukang paip dan pembinaan umum
木工、木匠、电工、水管工和一般建筑的理想选择

Standard Equipment: Recipro Saw Blades 3pcs (No. 21, 22, 23)



Continuous Rating Input Input Kuasa Berterusan 额定输入功率	1,010W
Length of Stroke Panjang Strok 冲程长度	28mm (1-1/8")
Strokes Per Minute (SPM) Kelajuan Strok 冲程速度	0 - 2,800
Capacity Kapasiti 能力	Pipe : 130mm (3-1/2") Wood: 255mm (10")
Overall Length Panjang Keseluruhan 总长度	452mm (17-3/4")
Net Weight Berat Bersih 净重	3.3kg (7.3lbs)
Power Supply Cord Kabel Wayar 电源线	2.5m (8.2ft)

JR3051TK

303

Recipro Saw

Gergaji Resipro
往复锯



- **Powerful 1,200W motor for improved performance**
Meningkatkan prestasi dengan motor 1,200W
强大的1,200W电机可提高性能

Standard Equipment: Recipro Saw Blades 3pcs (No. 21, 22, 23)



Continuous Rating Input Input Kuasa Berterusan 额定输入功率	1,200W
Length of Stroke Panjang Strok 冲程长度	30mm (1-3/16")
Strokes Per Minute (SPM) Kelajuan Strok 冲程速度	0 - 3,000
Capacity Kapasiti 能力	Pipe: 130mm (5-1/8") Wood: 255mm (10")
Dimensions (L x W x H) Dimensi 体积	447x97x176mm (17-5/8"x3-13/16"x6-15/16")
Net Weight Berat Bersih 净重	3.2 - 3.3kg (7.1 - 7.3lbs.)
Power Supply Cord Kabel Wayar 电源线	2.5m (8.2ft)

NEW
BARU | 新

SAWING

JR3070CT

303mm

Recipro Saw Gergaji Resipro 往复锯



- **Anti-Vibration Technology for 2X Less Vibration**
Mengurangkan getaran 2X dengan teknologi anti getaran 2x 倍减振的防振技术



Continuous Rating Input Input Kuasa Berterusan 额定输入功率	1,510W
Length of Stroke Panjang Strok 冲程长度	32mm (1-1/4")
Strokes Per Minute (SPM) Kelajuan Strok 冲程速度	0 - 2,800
Capacity Kapasti 能力	Pipe : 130mm (5-1/8") Wood: 255mm (10")
Overall Length Panjang Keseluruhan 总长度	485mm (19-1/8")
Net Weight Berat Bersih 净重	4.6kg (10lbs)
Power Supply Cord Kabel Wayar 电源线	2.5m (8.2ft)

Standard Equipment: Recipro Saw Blades 3pcs



SJ401

Scroll Saw Gergaji Scroll 平台式线锯机



- **Bevel cuts up to 45° to the left and 15° to the right**
Pemotongan serong sehingga 45° ke kiri dan 15° ke kanan
斜角向左切割45°，向右切割15°



Continuous Rating Input Input Kuasa Berterusan 额定输入功率	50W
Capacity Kapasti 能力	Thickness of cut : 50mm (2") Throat : 406mm (16")
Length of Stroke Panjang Strok 冲程长度	18mm (11/16")
Strokes Per Minute (SPM) Kelajuan Strok 冲程速度	400-1,600
Overall Length Panjang Keseluruhan 总长度	600mm (23-5/8")
Net Weight Berat Bersih 净重	14kg (30.87lbs)

Standard Equipment: Saw blade x6, Hex Wrench, Blade Change Rod



LB1200F

Band Saw Gergaji Band 带锯



- **High/ low speed selection for excellent results in both hard and soft wood**
Pemilihan kelajuan tinggi/ rendah untuk kayu keras dan lembut
高/低速选择，切割硬木和软木



Continuous Rating Input Input Kuasa Berterusan 额定输入功率	900W
Capacity Kapasti 能力	Thickness of cut : 165mm (6-1/2") Throat : 305mm (12")
Blade Speed Kelajuan Bilah 锯片速度	High: (50Hz)800 (60Hz)1,000m (50 Hz)2,624 (60 Hz) 3,280ft/ min Low: (50Hz)400 (60Hz)500m (50Hz)1,312 (60Hz) 1,640ft/ min
Dimensions (L x W x H) Dimensi 体积	615x775x1,600mm (24-1/4"x30-1/2"x63")
Net Weight Berat Bersih 净重	82kg (181.2lbs)
Power Supply Cord Kabel Wayar 电源线	2.5m (8.2ft)

Standard Equipment: Band Saw Blades, Rip Fence, Miter Gauge, Push Stick, Nozzle, Hex Wrench, Band Saw Stand



Cordless
Terdapat Model 20V, 40V, 18V

LED Flashlight
Lampu Cahaya LED
LEDORBIT

Vacuum Cleaner
Penyerap Vakuam
VACUUM

Drilling / Filing
Gergaji / Pengkilat
METAL / 金属

Impact Drilling / Demolition
Gergaji / Pemukul
METAL / 金属

Cutting
Panasir
METAL / 金属

Grinding / Sanding
Pengkilat / Pengkilat
METAL / 金属

Sawing
Gergaji
METAL / 金属

Planing / Routing
Pengkilat / Pengkilat
METAL / 金属

Others
Lain-lain
METAL / 金属

Outdoor Power Equipment
Alatan Kuasa Luar
METAL / 金属

Makita
METAL / 金属

PLANING ROUTERING

Mengetam | Tanggam 刨削 | 雕刻



KP0810 82mm (3-1/4")

132 W

Power Planer

Planer Elektrik
电刨



- **Powerful & lightweight**
Berkuasa & ringan
强力与轻量



Standard Equipment: Blade Gauge, Depth Guide, Guide Rule,
Planer Blade, Socket Wrench



Continuous Rating Input Input Kuasa Berterusan 额定输入功率	850W
Planing Width Lebar Pelan 刨削宽度	82mm (3-1/4")
Planing Depth Kedalaman Pelan 刨削深度	4mm (5/32")
No Load Speed (RPM) Kelajuan Tanpa Beban 回转速数	16,000
Dimensions (L x W x H) Dimensi 体积	290x168x176mm (11-3/8"x6-5/8"x6-15/16")
Net Weight Berat Bersih 净重	3.3kg (7.3lbs)
Power Supply Cord Kabel Wayar 电源线	2.5m (8.2ft)

KP0800X 82mm (3-1/4")

411 W

Power Planer

Planer Elektrik
电刨



- **High power & lightweight**
Kuasa tinggi & ringan
高功率与轻量



Standard Equipment: Planer Blade, Blade Gauge, Guide Rule,
Socket Wrench, Dust Nozzle



Continuous Rating Input Input Kuasa Berterusan 额定输入功率	620W
Planing Width Lebar Pelan 刨削宽度	82mm (3-1/4")
Planing Depth Kedalaman Pelan 刨削深度	2.5mm (3/32")
No Load Speed (RPM) Kelajuan Tanpa Beban 回转速数	17,000
Dimensions (L x W x H) Dimensi 体积	285x158x158mm (11-1/4"x6-1/4"x6-1/4")
Net Weight Berat Bersih 净重	2.8kg (6.2lbs)
Power Supply Cord Kabel Wayar 电源线	2.5m (8.2ft)

N1900B 82mm (3-1/4")

51 W

Power Planer

Planer Elektrik
电刨



- **V-groove on base for easy chamfer cutting**
V-groove pada dasar untuk pemotongan melencong mudah
底座上的V型槽，便于倒角切割



Standard Equipment: Sharpening Holder Assembly,
Blade Gauge, Socket Wrench, Planer Blade, Guide Rule



Continuous Rating Input Input Kuasa Berterusan 额定输入功率	580W
Planing Width Lebar Pelan 刨削宽度	82mm (3-1/4")
Planing Depth Kedalaman Pelan 刨削深度	1mm (1/32")
No Load Speed (RPM) Kelajuan Tanpa Beban 回转速数	16,000
Overall Length Panjang Keseluruhan 总长度	290mm (11-3/8")
Net Weight Berat Bersih 净重	2.8kg (6.1lbs)
Power Supply Cord Kabel Wayar 电源线	2.5m (8.2ft)

1911B 110mm (4-3/8")

106 W

Power Planer

Planer Elektrik
电刨



- **Powerful motor in compact and lightweight body**
Motor berkuasa badan padat dan ringan
马达功能强大，体积小巧轻便



Standard Equipment: Sharpening Holder Assembly, Blade
Gauge, Socket Wrench, Planer Blade



Continuous Rating Input Input Kuasa Berterusan 额定输入功率	840W
Planing Width Lebar Pelan 刨削宽度	110mm (4-3/8")
Planing Depth Kedalaman Pelan 刨削深度	2mm (1/16")
No Load Speed (RPM) Kelajuan Tanpa Beban 回转速数	16,000
Overall Length Panjang Keseluruhan 总长度	355mm (14")
Net Weight Berat Bersih 净重	4.1kg (9.1lbs)
Power Supply Cord Kabel Wayar 电源线	5.0m (16.4ft)

Cordless
Tangam Tidak BerbekalLED Flashlight
Lampu Cahaya LED
LED BRIGHTVacuum Cleaner
Penyerap Debu
HEPADrilling / Fastening
Gergaji / Pasang
MILWA / PASANGImpact Drilling / Demolition
Gergaji / Perseki
Gergaji Besi / Perseki BesiCutting
MemotongGrinding / Sanding
Menggosok / Mengkilap
Mengkilap / MengkilapSawing
GergajiPlaning / Routing
Mengkilap / MengkilapOthers
Lain-lain
Lain-lainOutdoor Power Equipment
Alat-alat Tenaga Luar
Alat-alat Tenaga LuarMakita
Makita

PLANING | ROUTERING

1805N 155mm (6-1/8")

153

Power Planer

Planer Elektrik
电刨



- **Rugged aluminum housing and easy depth settings**
Casing aluminium yang lasak dan penetapan kedalaman yang mudah
坚固的铝外壳和简单的深度设置

Standard Equipment: Sharpening Holder Assembly, Blade Gauge, Socket Wrench, Planer Blade



Continuous Rating Input Input Kuasa Berterusan 额定输入功率	1,140W
Planing Width Lebar Pelan 刨削宽度	155mm (6-1/8")
Planing Depth Kedalaman Pelan 刨削深度	2mm (1/16")
No Load Speed (RPM) Kelajuan Tanpa Beban 回转速数	15,000
Overall Length Panjang Keseluruhan 总长度	445mm (17-1/2")
Net Weight Berat Bersih 净重	7.9kg (17.3lbs)
Power Supply Cord Kabel Wayar 电源线	5.0m (16.4ft)

2012NB 304mm (12")

153

Planer

Planer Elektrik
电刨



- **Powerful 1,650W motor for improved performance**
Motor 1,650W yang berkuasa meningkatkan prestasi
功率强劲的1,650W马达提高了性能

Standard Equipment: Socket Wrench, Hex Wrench, Magnetic holder x2



Continuous Rating Input Input Kuasa Berterusan 额定输入功率	1,650W
Cutting Width Lebar Pelan 刨削宽度	304mm (12")
Cutting Depth Kedalaman Pelan 刨削深度	Cutting width 0-150mm: 3mm (1/8") Cutting width 150-240mm : 1.5mm (1/16")
Feed Rate (min) Kadar Suapan 进料速度	8.5m (27.9ft)
Table Size (W x L) Saiz Meja 工作台尺寸	304 x 771mm (12" x 30-3/8")
No Load Speed (RPM) Kelajuan Tanpa Beban 回转速数	8,500
Dimensions (L x W x H) Panjang Keseluruhan 总长度	483x771x401mm (19"x30-3/8"x15-13/16")
Net Weight Berat Bersih 净重	27.1 - 27.6kg (59.7 - 60.9lbs)
Power Supply Cord Kabel Wayar 电源线	2.5m (8.2ft)

3501N

153

Groove Cutter

Pemotong alur
沟锯



- **Powerful motor, easy depth adjustment**
Motor berkuasa, pelarasan kedalaman yang mudah
强大的马达，容易调整深度

Standard Equipment: Saw Blade (A-87507), Shiplapping Scale, Rip Fence (Guide Rule), Dressing Stone, Wrench x2, Screwdriver, Cutter Blade



Continuous Rating Input Input Kuasa Berterusan 额定输入功率	1,160W
Max Cutter Blade Size Saiz Bilah Maksimum 最大锯片尺寸	Dia. x Width: 120x36mm (4-3/4"x1-3/8")
Max Cutting Depth Kedalaman Pemotongan Maksimum 最大切割深度	Cutter/ Saw: 30mm (1-1/8")/ 65 mm (2-1/2")
No Load Speed (RPM) Kelajuan Tanpa Beban 回转速数	6,500
Overall Length Panjang Keseluruhan 总长度	365mm (14-3/8")
Net Weight Berat Bersih 净重	7.2kg (15.8lbs)
Power Supply Cord Kabel Wayar 电源线	5.0m (16.4ft)

PJ7000

459

Plate Joiner

Mesin Kerja Kayu
木工接合机



- **Large and easy-to-operate cam locks for fence adjustments**
Pelarasan pagar yang mudah
简易栅栏调节

Standard Equipment: Cutter Blade, Angle Guide, Dust Bag, Set Plate, Lock Nut Wrench



Continuous Rating Input Input Kuasa Berterusan 额定输入功率	701W
Blade Diameter Diameter Bilah 锯片直径	100mm (4")
No Load Speed (RPM) Kelajuan Tanpa Beban 回转速数	11,000
Dimensions (L x W x H) Dimensi 体积	302x139x145mm (11-7/8"x5-1/2"x5-3/4")
Net Weight Berat Bersih 净重	2.8kg (6.2lbs)
Power Supply Cord Kabel Wayar 电源线	2.5m (8.2ft)



Cordless
Tempat Ford 3.6V

LED Flashlight
Lampu Suhu LED
LECOM 9012

Vacuum Cleaner
Penjeruk Vakuam
BL230

Drilling / Fastening
Gergah / Pengikat
M18 / 3.6V

Impact Drilling / Demolition
Gergah / Pemusnah
M18 / 3.6V / 8.4V / 12V

Cutting
Pemotong
M18 / 3.6V

Grinding / Sanding
Pengkilan / Pasukan
M18 / 3.6V

Sawing
Gergah
M18 / 3.6V

Planing / Routing
Pengkilan / Tugasan
M18 / 3.6V

Others
Lain-lain
M18 / 3.6V

Outdoor Power Equipment
Alatan Kerja Luar
M18 / 3.6V

Makita
M18 / 3.6V

PLANING | ROUTERING

3901

411

Plate Joiner

Mesin Kerja Kayu
木工接合机



- **Designed for making strong plate joints fast**
Direka untuk penyambungan rata
用于快速制作坚固的平板接头



Standard Equipment: Cutter Blade, Angle Guide, Dust Bag, Set Plate, Lock Nut Wrench



Continuous Rating Input Input Kuasa Berterusan 额定输入功率	590W
Blade Diameter Diameter Bilah 锯片直径	100mm (4")
Max Cutting Depth Kedalaman Pemotongan Maksimum 最大切割深度	20mm (3/4")
No Load Speed (RPM) Kelajuan Tanpa Beban 回转数	11,000
Overall Length Panjang Keseluruhan 总长度	307mm (12-1/16")
Net Weight Berat Bersih 净重	3.0kg (6.6lbs)
Power Supply Cord Kabel Wayar 电源线	2.5m (8.2ft)

RT0700C / X2 6mm (1/4"), 8mm (3/8")

411

Trimmer

Pemangkas
修边雕刻机



- **Powerful 710W motor for improved performance**
Motor berkuasa 710W untuk prestasi yang lebih baik
强大710W马达提高了性能



For RT0700X2 only



Standard Equipment:

RT0700C: Collet Cone, Trimmer Base Assembly, Straight Guide, Dust Nozzle, Wrench x2

RT0700X2: Collet Cone, Trimmer Base Assembly, Straight Guide, Dust Nozzle, Wrench x2, Side Grip, Templet Guide, Tilt Base Assembly, Plunge Base Assembly, Tool Bag

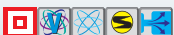

Continuous Rating Input Input Kuasa Berterusan 额定输入功率	710W
Collet Capacity Kapasiti Collet 夹头直径	6mm, 8mm or 1/4", 3/8"
No Load Speed (RPM) Kelajuan Tanpa Beban 回转数	10,000 - 30,000
Dimensions (L x W x H) Dimensi 体积	89x89x200mm (3-1/2"x3-1/2"x7-7/8")
Net Weight Berat Bersih 净重	1.8 - 2.7kg (3.9 - 6.0lbs)
Power Supply Cord Kabel Wayar 电源线	2.5m (8.2ft)

3709 6mm (1/4")

411

Trimmer

Pemangkas
修边雕刻机

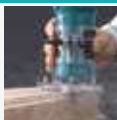

- **530W motor for smooth trimming**
530W motor untuk pemangkas yang licin
530W马达提供平滑的修剪



Standard Equipment: Collet Cone, Trimmer Guide, Straight Guide Assembly, Templet Guide, Straight Bit, Chip Deflector, Wrench x2



Continuous Rating Input Input Kuasa Berterusan 额定输入功率	530W
Collet Capacity Kapasiti Collet 夹头直径	6mm or 1/4"
No Load Speed (RPM) Kelajuan Tanpa Beban 回转数	30,000
Dimensions (L x W x H) Dimensi 体积	82x90x199mm (3-1/4"x3-1/2"x7-7/8")
Net Weight Berat Bersih 净重	1.5kg (3.3lbs)
Power Supply Cord Kabel Wayar 电源线	2.5m (8.2ft)

RP0900 6mm (1/4"), 8mm (3/8")

106

Router (Plunge type)

Pemangkas
雕刻机



- **Oversized ball bearing construction for longer tool life**
Konstruksi gelas bebola untuk memanjangkan hayat alat
超大滚珠轴承结构, 延长工具寿命



Standard Equipment: Straight Guide, Straight Bit, Collet cone x2, Wrenches



Continuous Rating Input Input Kuasa Berterusan 额定输入功率	900W
Collet Capacity Kapasiti Collet 夹头直径	6mm, 8mm or 1/4", 3/8"
Plunge Capacity Kapasiti Plunge 能力	0 - 35mm (0 - 1-3/8")
No Load Speed (RPM) Kelajuan Tanpa Beban 回转数	27,000
Dimensions (L x W x H) Dimensi 体积	110x256x217mm (4-5/16"x10-3/32"x8-17/32")
Net Weight Berat Bersih 净重	2.7kg (6lbs)
Power Supply Cord Kabel Wayar 电源线	2.5m (8.2ft)

RP2301FC 12mm (1/2")

203

Router (Plunge type)

Pemangkas
雕刻机



- **Powerful 2,100W motor for the most demanding applications**
Motor 2,100W berkuasa untuk aplikasi yang paling mencabar
功能强大2,100W马达, 适用于要求苛刻的应用



Standard Equipment: Straight Guide, Collet Cone, Wrench, Screw M6x135, Straight Bit 1/2" (D-07901)



Continuous Rating Input Input Kuasa Berterusan 额定输入功率	2,100W
Collet Capacity Kapasiti Collet 夹头直径	12mm or 1/2"
Plunge Capacity Kapasiti Plunge 能力	0 - 70mm (0 - 2-3/4")
No Load Speed (RPM) Kelajuan Tanpa Beban 回转数	9,000 - 22,000
Dimensions (L x W x H) Dimensi 体积	155x294x312mm (6-1/8"x11-5/8"x12-1/4")
Net Weight Berat Bersih 净重	6.1kg (13.5lbs)
Power Supply Cord Kabel Wayar 电源线	4.0m (13.1ft)

PLANING | ROUTERING

RP1801 12mm (1/2") 203 mm

Router (Plunge type)
Pemangkas
雕刻机



- **Electric brake for increased operator safety**
Brake elektrik untuk pengguna keselamatan
电子自动刹车

Standard Equipment: Straight Guide, Collet Cone, Wrench, Screw M6x135, Template Guide



Continuous Rating Input Input Kuasa Berterusan 额定输入功率	1,650W
Collet Capacity Kapasiti Collet 夹头直径	12mm or 1/2"
Plunge Capacity Kapasiti Plunge 能力	0 - 70mm (0 - 2-3/4")
Base Dia. Diameter Pangkalan 底座直径	170mm (6-11/16")
No Load Speed (RPM) Kelajuan Tanpa Beban 回转数	22,000
Dimensions (L x W x H) Dimensi 体积	155x294x312mm (6-1/8"x11-5/8"x12-1/4")
Net Weight Berat Bersih 净重	6kg (13.2lbs)
Power Supply Cord Kabel Wayar 电源线	4.0m (13.1ft.)

3612BR 12mm (1/2") 153 mm

Router (Plunge type)
Pemangkas
雕刻机



- **Conveniently located plunge lock lever for efficient operation**
Pelarasan tool yang mudah untuk operasi yang cekap
便利的插入式锁定杆可实现高效操作

Standard Equipment: Straight Guide, Templet Guide, Trimmer Guide, Guide Holder, Collet Sleeve (6mm or 1/4"), Collet Sleeve (8mm or 3/8"), Straight Bit (Carbide-Tipped) D-07901, Wrench



Continuous Rating Input Input Kuasa Berterusan 额定输入功率	1,600W
Collet Capacity Kapasiti Collet 夹头直径	12mm or 1/2"
Plunge Capacity Kapasiti Plunge 能力	0 - 65mm (0 - 2-9/16")
No Load Speed (RPM) Kelajuan Tanpa Beban 回转数	23,000
Dimensions (L x W x H) Dimensi 体积	160x276x287mm (6-5/16"x10-7/8"x11-5/16")
Net Weight Berat Bersih 净重	5.5kg (12.1lbs)
Power Supply Cord Kabel Wayar 电源线	2.5m (8.2ft.)



3600H 12mm (1/2") 153 mm

Router
Pemangkas
雕刻机



- **D-handle design with locking trigger switch for comfort during continuous operation**
Pemegang-D dengan suis pencetus berkunci untuk keselesaan semasa operasi berterusan
带锁定扳机开关的D型手柄设计可确保连续操作时的舒适性

Standard Equipment: Trimmer Guide, Straight Guide Assembly, Templet Guide, Collet Sleeve (6mm or 1/4"), Collet Sleeve (8mm or 3/8"), Wrench, Straight Bit (Carbide-Tipped) D-07901

Continuous Rating Input Input Kuasa Berterusan 额定输入功率	1,500W
Collet Capacity Kapasiti Collet 夹头直径	12mm or 1/2"
Base Dia. Diameter Pangkalan 底座直径	160mm (6-1/4")
No Load Speed (RPM) Kelajuan Tanpa Beban 回转数	24,000
Overall Height Panjang Keseluruhan 总长度	210mm (8-1/4")
Net Weight Berat Bersih 净重	4.4kg (9.8lbs)
Power Supply Cord Kabel Wayar 电源线	5.0m (16.4ft)

4403 6mm (1/4") 411 mm

Sash Router
Pemangkas Sash
窗扇雕刻机



- **Large transparent chip guard for operator's safety**
Pengawal cip telus yang besar untuk keselamatan pengguna
大型透明芯片防护罩保证操作者的安全

Standard Equipment: Collet cone (6mm or 1/4"), Drill Point Sash Router Bit (D-16972), Angle Gauge, Wrench x2, Oil supply



Continuous rating input Input Kuasa Berterusan 额定输入功率	530W
Capacity Kapasiti 能力	Collet: 6mm or 1/4"
Max Width of Work Lebar Kerja Maksimum 最大工作宽度	123mm (4-7/8")
Max Width of Work (45°) Lebar Kerja Maksimum 最大工作宽度	77mm (3")
Max Height of Work Ketinggian Kerja Maksimum 最大工作高度	185mm (7-1/4")
No Load Speed (RPM) Kelajuan Tanpa Beban 回转数	30,000
Dimensions (L x W x H) Dimensi 体积	327x350x355mm (12-7/8"x13-13/16"x14")
Net Weight Berat Bersih 净重	16kg (35.3lbs)
Power Supply Cord Kabel Wayar 电源线	2.5m (8.2ft)

Cordless
Tempat Kord Jarak, LED
Lampu Suhu LED
LTCOR 1612
Vacuum Cleaner
(Penjerap Vakuam)
集尘器
Drilling / Fastening
Cairul / Pengikat
钻孔 / 紧固
Impact Drilling / Demolition
Cairul / Pemusnah
钻孔 / 拆除
Cutting
Pemotong
切割
Grinding / Sanding
Pengkilan / Pucuk
磨削 / 打磨
Sawing
Gergaji
锯切
Planing / Routing
Pangkas / Tumpang
刨削 / 雕刻
Others
Lain-lain
其他
Outdoor Power Equipment
Alatan Kerja Luar
户外动力设备



OTHERS

Lain-lain 其他



AF506

419 WMI

Pneumatic Brad Nailer
Penembak Paku Brad Pneumatik
气钉枪



- **Lightweight for reduced operator fatigue**
Ringan untuk mengurangi kelelahan pengguna
轻量不易引起疲劳



Standard Equipment: Safety Goggles, Nose Adapter, Oil



Capacity Kapasiti 能力	Length: 15 - 50mm (5/8" - 2")
Operating Pressure Tekanan Beroperasi 使用气压	Gauge: 18Ga 0.49 - 0.83MPa (70 - 120PSI)
Magazine Capacity Bilangan Staples 装订个数	100
Compressed Air Udara Mampat 压缩空气	Driver stroke: 85.5mm (3-3/8") Cylinder bore diameter: 28mm (1-1/8")
Dimensions (L x W x H) Dimensi 体积	250x70x256mm (9-7/8"x2-3/4"x10-1/8")
Net Weight Berat Bersih 净重	1.3kg (2.9lbs.)

Accessories (optional)			
Description	Size	Pcs/ Box	Part No.
Brad Nail 15mm (5/8")	F15	5,000	B-04307
Brad Nail 20mm (3/4")	F20	5,000	B-04313
Brad Nail 25mm (1")	F25	5,000	B-04329
Brad Nail 30mm (1-3/16")	F30	5,000	B-04335
Brad Nail 35mm (1-3/8")	F35	5,000	B-04357

AF353

Pneumatic Pin Nailer
Mesin Pemaku Pneumatik
气钉枪



- **Lightweight for reduced operator fatigue**
Ringan untuk mengurangi kelelahan pengguna
轻量不易引起疲劳



Standard Equipment: Safety Goggles, Nose Adapter, Hex Wrench, Oil



Capacity Kapasiti 能力	Length: 15 - 35mm (5/8" - 1-3/8")
Operating Pressure Tekanan Beroperasi 使用气压	Gauge: 23Ga 0.45 - 0.69MPa (65 - 100PSI)
Magazine Capacity Bilangan Staples 装订个数	130
Dimensions (L x W x H) Dimensi 体积	208x66x191mm (8-3/16"x2-5/8"x7-1/2")
Net Weight Berat Bersih 净重	0.9kg (2lbs.)

Accessories (optional)			
Description	Size	Pcs/ Box	Part No.
Brad Nail 15mm (5/8")	F15	5,000	B-04307
Brad Nail 20mm (3/4")	F20	5,000	B-04313
Brad Nail 25mm (1")	F25	5,000	B-04329
Brad Nail 30mm (1-3/16")	F30	5,000	B-04335
Brad Nail 35mm (1-3/8")	F35	5,000	B-04357

AF601

Pneumatic Finish Nailer
Mesin Pemaku Pneumatik
气钉枪



- **Lightweight for reduced operator fatigue**
Ringan untuk mengurangi kelelahan pengguna
轻量不易引起疲劳



Standard Equipment: Safety Goggles, Nose Adapter, Oil



Capacity Kapasiti 能力	Length: 25 - 64mm (1" - 2-1/2")
Operating Pressure Tekanan Beroperasi 使用气压	Gauge: 16Ga 0.49 - 0.83MPa (70 - 120PSI)
Magazine Capacity Bilangan Staples 装订个数	100
Dimensions (L x W x H) Dimensi 体积	304x95x297mm (12"x3-3/4"x11-3/4")
Net Weight Berat Bersih 净重	1.7kg (3.8lbs.)

Accessories (optional)			
Description	Size	Pcs/ Box	Part No.
Brad Nail 25mm (1")	F25	5,000	B-04329
Brad Nail 30mm (1-3/16")	F30	5,000	B-04335
Brad Nail 35mm (1-3/8")	F35	5,000	B-04357

AF635

Pneumatic Finish Nailer
Mesin Pemaku Pneumatik
气钉枪



- **Lightweight for reduced operator fatigue**
Ringan untuk mengurangi kelelahan pengguna
轻量不易引起疲劳



Standard Equipment: Safety Goggles, Nose Adapter, Oil



Capacity Kapasiti 能力	Length: 32 - 64mm (1-1/4" - 2-1/2")
Operating Pressure Tekanan Beroperasi 使用气压	Gauge: 15Ga 0.49 - 0.83MPa (70 - 120PSI)
Magazine Capacity Bilangan Staples 装订个数	100
Dimensions (L x W x H) Dimensi 体积	339x100x309mm (13-3/8"x3-15/16"x12-1/8")
Net Weight Berat Bersih 净重	1.8kg (4lbs.)

Accessories (optional)			
Description	Size	Pcs/ Box	Part No.
Brad Nail 35mm (1-3/8")	F35	5,000	B-04357

OTHERS

AT638A

Narrow Crown Stapler Mesin Pemaku Pneumatik 气钉枪



- **Lightweight for reduced operator fatigue**
Ringan untuk mengurangkan kelelahan pengguna
轻量不易引起疲劳

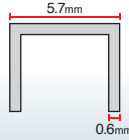

Standard Equipment:
Safety Goggles, Nose Adapter, Oil



Capacity Kapasiti 能力	Length: 13 - 38mm (1/2" - 1-1/2") Gauge: 15Ga Width: 5.7mm
Operating Pressure Tekanan Beroperasi 使用气压	0.49 - 0.83MPa (70 - 120PSI)
Magazine Capacity Bilangan Staples 装订个数	100
Dimensions (L x W x H) Dimensi 体积	230x75x251mm (9"x2-15/16"x9-7/8")
Net Weight Berat Bersih 净重	1.2kg (2.7lbs.)



Heat Gun Accessories (Optional) Pistol Udara Panas 热风枪

Shape	Part No.
Glass protection nozzle	PR00000028
Wide-slot nozzle	PR00000029
Reflector nozzle	PR00000030
Reduction nozzle 20	PR00000031
Overlap welding nozzle	PR00000032
Solder sleeves reflector	PR00000033

Shape	Part No.
Welding nozzle	PR00000034
Pressure roller	PR00000035
Welding rods	ABS PR00000036
	HDPE PR00000037
	PP PR00000038
Speed welding nozzle	PR00000039
Scraper	PR00000040
Scraper set	PR00000041
Scraper	PR00000042

HG6530VK

Heat Gun Pistol Udara Panas 热风枪



- **3-speed blower settings for greater versatility**
Kawalan kelajuan 3 tahap untuk pelbagai aplikasi
3速度控制适合多种用途

Standard Equipment: Glass Protection Nozzle, Reflector Nozzle, Reduction Nozzle, Wide Slot Nozzle



Air Temperature (°C) Suhu Udara 气温	50 - 650
Air Flow Aliran Udara 空气流量	Stage 1: 500 L/min Stage 2: 280 L/min Stage 3: 550 L/min
Dimensions (L x W x H) Dimensi 体积	257x85x206mm (10-1/8"x3-3/8"x8-1/8")
Net Weight Berat Bersih 净重	0.72kg (1.6lbs.)
Power Supply Cord Kabel Wayar 电源线	2.0m (6.6ft)

Cordless
Tanda Kordless

LED Flashlight
Lampu Suhu LED
LED 闪光灯

Vacuum Cleaner
Pembersih Vakuum
吸尘器

Drilling / Fastening
Cairul / Pasang
钻孔 / 紧固

Impact Drilling / Demolition
Cairul / Hancurkan
冲击钻孔 / 拆除

Cutting
Pemotongan
切割

Grinding / Sanding
Pergilas / Pasah
磨削 / 打磨

Sawing
Gergaji
锯切

Planing / Routing
Meratakan / Mengukir
刨平 / 雕刻

Others
Lain-lain
其他

Outdoor Power Equipment
Alatan Kuasa Luar
户外动力设备

Makita
1911

OTHERS

HG6531CK

Heat Gun

Pistol Udara Panas
热风枪



- 5-speed blower settings for greater versatility
Kawalan kelajuan 5 tahap untuk pelbagai aplikasi
5速度控制适合多种用途



Air Temperature (°C) Suhu Udara 气温	50 - 650
Air Flow Aliran Udara 空气流量	200 - 550 L/min
Dimensions (L x W x H) Dimensi 体积	257x85x206mm (10-1/8"x3-3/8"x8-1/8")
Net Weight Berat Bersih 淨重	0.71kg (1.6lbs.)
Power Supply Cord Kabel Wayar 电源线	2.0m (6.6ft)

HG6031VK

Heat Gun

Pistol Udara Panas
热风枪



- 9-temperature settings (50 - 600°C) for a variety of applications
9 tetapan suhu (50 - 600°C) sesuai untuk pelbagai aplikasi
9个温度设定 (50 - 600°C) 适合于各种用途

Standard Equipment: Glass Protection Nozzle, Reflector Nozzle, Reduction Nozzle, Wide Slot Nozzle



Continuous Rating Input Input Kuasa Berterusan 额定输入功率	1,800W
Air Temperature (°C) / Flow (L/min) Suhu Udara 气温	Switch 1: 50 - 400 / 250 Switch 2: 100 - 600 / 500
Dimensions (L x W x H) Dimensi 体积	257x85x206mm (10-1/8"x3-3/8"x8-1/8")
Net Weight Berat Bersih 淨重	0.67kg (1.5lbs)
Power Supply Cord Kabel Wayar 电源线	2.0m (6.6ft)

HG5030K

Heat Gun

Pistol Udara Panas
热风枪



- 2 temperature settings (350 and 500°C)
2 tetapan suhu (350 dan 500°C)
2个温度设定 (350和500°C)

Standard Equipment: Glass Protection Nozzle, Reflector Nozzle, Reduction Nozzle, Wide Slot Nozzle



Continuous Rating Input Input Kuasa Berterusan 额定输入功率	1,600W
Air Temperature (°C) / Flow (L/min) Suhu Udara 气温	Switch 1: 350 / 300 Switch 2: 500 / 500
Dimensions (L x W x H) Dimensi 体积	233x80x208mm (9-1/8"x3-1/8"x8-3/16")
Net Weight Berat Bersih 淨重	0.56kg (1.2lbs)
Power Supply Cord Kabel Wayar 电源线	2.0m (6.6ft)

SK104Z

Cross Line Laser

Laser Garis Salib
十字线激光



- Accuracy +/- 3mm @ 10m
Ketepatan +/- 3mm @ 10m
精确度 +/- 3mm @ 10m

Standard Equipment: Wall Mount Bracket, Target Plate, AA Battery, Pouch with strap

Measuring Range Jarak Mengukur 测量范围	Up to: 15m w/ detector up to: 60m
Leveling Accuracy Menunjukkan Ketepatan 指示精确度	±3mm/ 10m
Self-leveling Range Julat Indikasi Menegak 垂直指示范围	4+-1°
Laser Fan Angle Sudut Peminat Laser 激光扇角	Horizontal: 180° Vertical: 180°
Number of Laser Bilangan Garisan Laser 激光线数量	points: 4 lines: 2
Laser Type Jenis Laser 激光类型	Laser class 2: 635nm
Tripod Thread Tripod 脚架	1/4"
Protection Class Tahap Perlindungan 保护等级	IP54
Net Weight Berat Bersih 淨重	0.53kg (1.17lbs)

LD030P

Laser Distance Measure

Langkah Jarak Laser
激光测距



- Measuring distance operating range up to 30m
Mengukur jarak operasi jarak sehingga 30m
测量距离可达30米

Standard Equipment: AAA Alkaline Dry Battery 1.5V x2

Measuring Range Jarak Mengukur 测量范围	0.2-30m
Typical Measuring Tolerance Toleransi Mengukur Biasa 典型的测量公差	±2.0mm/ 10m
Max Measuring Tolerance Toleransi Mengukur Maksimum 最大测量公差	±3.0mm/ 10m
Diameter of Laser Point Diameter Titik Laser 激光点的直径	6mm/ 10m
Laser Type Jenis Laser 激光类型	Laser class 2: 635nm
Dimensions (H x D x W) Dimensi 体积	117x53x25mm (4.5"x2.14"x1")
Net Weight Berat Bersih 淨重	0.1kg (0.22lbs)

OTHERS

LD050P

Laser Distance Measure

Langkah Jarak Laser
激光测距



- **Measuring distance operating range up to 50m**
Mengukur jarak operasi jarak sehingga 50m
测量距离可达50米

Standard Equipment: AAA Alkaline Dry Battery 1.5V x2, Pouch

Measuring Range Jarak mengukur 测量范围	0.05-50m
Power Supply Bekalan Kuasa 电源	Cell battery : AAA 1.5V x 2pcs
Net Weight Berat Bersih 净重	0.1kg (0.22lbs)

LD080P / PI

Laser Distance Measure

Langkah Jarak Laser
激光测距



- **Measuring distance operating range up to 80m**
Mengukur jarak operasi jarak sehingga 80m
测量距离可达80米

Standard Equipment: AAA Alkaline Dry Battery 1.5V x2,
Carrying Strap, Pouch

Measuring Range Jarak mengukur 测量范围	0.05-80m
Power Supply Bekalan Kuasa 电源	Cell battery : AAA 1.5V x 2pcs
Net Weight Berat Bersih 净重	0.14kg (0.31lbs)

UB1103

Blower

Mesin Blower
吹风机



- **Two tools in one; quickly converts to a vacuum for added versatility**
Alat 2 dalam 1, vakum dan blower untuk fleksibiliti tambahan
一机2用, 集尘与吹风

Standard Equipment: Nozzle, Dust Bag



Continuous Rating Input Input Kuasa Berterusan 额定输入功率	600W
Max Air Volume Isipadu Angin Maksimum 最大风量	0 - 4.1m ³ /min
Max Air Velocity Velositi Angin Maksimum 最大风速	0 - 91m/s
Air Pressure Tekanan Udara 气压	0 - 5.7kPa
No Load Speed (RPM) Kelajuan Tanpa Beban 回转数	0 - 16,000
Dimensions (L x W x H) Dimensi 体积	479x185x178mm (18-7/8"x7-1/4"x7")
Net Weight Berat Bersih 净重	1.9 - 2.2kg (4.3 - 4.8lbs)
Power Supply Cord Kabel Wayar 电源线	2.5m (8.2ft.)

HS100

Hammer Tacker

Alat Manual Memaku Mesin
手动工具敲钉机



Capacity Kapasiti 能力	Width: 12mm Length: 6 - 10mm
Magazine Capacity Bilangan Staples 装订个数	144
Dimensions (L x W x H) Dimensi 体积	281mm
Net Weight Berat Bersih 净重	0.5kg



Cordless
Tanpa Kabel 无线

LED Flashlight
Lampu Suhu LED
LED照明灯

Vacuum Cleaner
Penjerap Vakum
吸尘器

Drilling / Fastening
Cajaja / Pengikat
钻孔 / 紧固

Impact Drilling / Demolition
Cajaja / Pengikat
冲击钻孔 / 拆除

Cutting
Pemotong
切割

Grinding / Sanding
Penggosok / Pasir
打磨 / 砂磨

Sawing
Gergaji
锯切

Planing / Routing
Mencam / Tenggam
刨削 / 雕刻

Others
Lain-lain
其他

Outdoor Power Equipment
Alatan Kuasa Luar
户外动力设备

Makita
マキタ

Cordless
Tangan Bantol 充电式
手柄

LED Flashlight
Lampu Flash LED
LED 闪光灯

Vacuum Cleaner
Pembersih Vakuüm
吸尘器

Drilling / Fastening
Gergaji / Penutup
电钻 / 螺丝

Impact Drilling / Demolition
Gergaji / Pemukul
电钻/电锤 / 拆除工具

Cutting
Pemotong
切割

Grinding / Sanding
Penggosok / Halus
打磨 / 磨光

Sawing
Gergaji
锯切

Planing / Routing
Penghalus / Tergoyong
刨平 / 雕刻

Others
Lain-lain
其他

Outdoor Power Equipment
Alatan Krafis Luar
户外动力设备

Makita
MAKITA

OUTDOOR POWER EQUIPMENT

Alat Berkebun 园艺工具



EBH340U 33.5mL 4-stroke

Petrol Brushcutter
Pemotong Rumput Petrol
汽油割草机



- **Meets all environmental standards**
Memenuhi standard mesra alam
符合所有环保标准

Standard Equipment: Star Blade, Protector, Hex Wrench, Socket Wrench, Oil (195501-2), Accessory Bag



Sementara stok masih ada
WHILE STOCK LAST
工具存货 有限

Displacement Sesaran 排量	33.5mL
Engine Power Kuasa Enjin 发动机功率	1.07kW/ 1.5PS
Fuel Tank Capacity Tangki Minyak 油箱容量	0.65L
Spindle Size Saiz Spindel 主轴尺寸	M10 x 1.25LH
Dimensions (L x W x H) Dimensi 体积	1,900x645x510mm (74-3/4"x25-3/8"x20")
Net Weight Berat Bersih 净重	7.5kg (16.5lbs)

EM2654LH 25.4mL 4-stroke

Petrol Brushcutter
Pemotong Rumput Petrol
汽油割草机

- **No oil mixing needed. Lower emissions**
Tanpa pencampuran petrol, perlepasan asap lebih rendah
无需汽油混合，降低排气

Standard Equipment: Shoulder Harness, Metal Blade / Nylon Cutting Head (country-specific), Blade cover (for the product with metal blade), Box Driver, Hex Wrench, Accessory Bag



Sementara stok masih ada
WHILE STOCK LAST
工具存货 有限

Displacement Sesaran 排量	25.4mL
Max Output Keluaran Maksima 最大输出	0.77kW (1.1HP) @ 7,000RPM
Fuel Tank Capacity Tangki Minyak 油箱容量	0.6L (20.3 oz.)
Oil Tank Capacity Kapasiti Tangki Minyak 润滑油箱	0.08L (2.7 oz.)
Cutting Width Lebar Keratan 切割宽度	Metal Blade: 230mm (9-1/16") Nylon Cutting Head: 420mm (16-1/2")
Spindle Size Saiz Spindel 主轴尺寸	M10 x 1.25LH
Dimensions (L x W x H) Dimensi 体积	1,765x368x293mm (69-1/2"x14-1/2"x11-1/2")
Net Weight Berat Bersih 净重	5.2kg (11.5lbs)

RBC411U 40.2mL

Petrol Brushcutter
Pemotong Rumput Petrol
汽油割草机



- **Powerful and reliable 40.2mL engine**
Enjin 40.2mL yang kuat dan boleh dipercayai
强力可靠的40.2mL引擎

Standard Equipment: Metal Blade, Protector, Shoulder Belt, Tool Set, Accessory Bag



Sementara stok masih ada
WHILE STOCK LAST
工具存货 有限

Displacement Sesaran 排量	40.2mL
Engine Power Kuasa Enjin 发动机功率	1.40kW/ 2.0PS
Fuel Tank Capacity Tangki Minyak 油箱容量	1.1L
Spindle Size Saiz Spindel 主轴尺寸	M10 x 1.25LH
Dimensions (L x W x H) Dimensi 体积	1,710x670x430mm (67-1/2"x26-3/8"x17")
Net Weight Berat Bersih 净重	7.3kg (16.1lbs)

EM3400U 34.0mL

Petrol Brushcutter
Pemotong Rumput Petrol
汽油割草机



- **Waist cushion for added comfort in long continuous operation**
Kusyen pinggang untuk keselesaan tambahan dalam operasi berterusan yang panjang
腰部靠垫在长时间连续操作中增加了舒适度

Standard Equipment: Metal Blade, Protector, Blade Cover, Accessory Bag, Shoulder harness with double shoulder strap, Socket Wrench, Hex Wrench



Displacement Sesaran 排量	34.0mL
Engine Power Kuasa Enjin 发动机功率	1.15kW/ 1.6PS
Fuel Tank Capacity Tangki Minyak 油箱容量	0.75L
Spindle Size Saiz Spindel 主轴尺寸	M10 x 1.25LH
Dimensions (L x W x H) Dimensi 体积	1,815x650x435mm (71-1/2"x25-1/2"x17-1/8")
Net Weight Berat Bersih 净重	6.4kg (14.1lbs)

OUTDOOR POWER EQUIPMENT

EM3400L 34.0mL

Petrol Brushcutter

Pemotong Rumput Petrol
汽油割草机



- **Lightweight for reduced operator fatigue**
Ringan untuk mengurangkan keletihan pengguna
轻量, 减少使用者的疲劳

Standard Equipment: Cutter Blade (196895-8), Protector, Band Assembly, Socket Wrench, Hex Wrench, Screwdriver, Accessory Bag



Displacement Sesaran 排量	34.0mL
Engine Power Kuasa Enjin 发动机功率	1.15kW/ 1.6PS
Fuel Tank Capacity Tangki Minyak 油箱容量	0.75L
Spindle Size Saiz Spindel 主轴尺寸	M10 x 1.25LH
Dimensions (L x W x H) Dimensi 体积	1,815x330x270mm (71-1/2"x13"x10-5/8")
Net Weight Berat Bersih 净重	6.2kg (13.7lbs)

EM2600U 25.7mL 2-stroke

Petrol Brushcutter

Pemotong Rumput Petrol
汽油割草机



- **Primer bulb and choke for easy starting**
Mudah dihidupkan
易于启动

Standard Equipment: Star Blade, Nylon Cutting Head, Socket Wrench, Hex Wrench, Shoulder Belt



Displacement Sesaran 排量	25.7mL
Engine Power Kuasa Enjin 发动机功率	0.83kW/ 1.2PS
Fuel Tank Capacity Tangki Minyak 油箱容量	0.6L
Spindle Size Saiz Spindel 主轴尺寸	M8 x 1.25LH
Dimensions (L x W x H) Dimensi 体积	1,770x610x410mm (69-3/4"x24"x16-1/8")
Net Weight Berat Bersih 净重	5kg (11lbs)

EM4350RH 43.0mL 4-stroke

Backpack Petrol Brushcutter

Pemotong Rumput Beg Galas
Petrol
背负式汽油割草机



- **4-stroke engine requires no fuel mix**
Enjin 4-strok tidak memerlukan campuran minyak
四冲程发动机不需要混合燃料

Standard Equipment: Metal Blade, Protector, Blade cover, Accessory Bag, Oil, Box Wrench



Displacement Sesaran 排量	43.0mL
Engine Power Kuasa Enjin 发动机功率	1.5kW/ 2.1PS
Fuel Tank Capacity Tangki Minyak 油箱容量	0.8L
Spindle Size Saiz Spindel 主轴尺寸	M10 x 1.25LH
Dimensions (L x W x H) Dimensi 体积	358x280x587mm (14-1/8"x11"x23-1/8")
Net Weight Berat Bersih 净重	12.1kg (26.7lbs)

EBH340R 33.5mL 4-stroke

Backpack Petrol Brushcutter

Pemotong Rumput Beg Galas
Petrol
背负式汽油割草机



- **Powerful fuel efficient 33.5cc MM4 commercial duty engine**
Enjin berat komersial MM4 33.5cc
强力的33.5cc MM4商用引擎

Standard Equipment: Blade, Tool set



Displacement Sesaran 排量	33.5mL
Engine Power Kuasa Enjin 发动机功率	1.07kW/ 1.45PS
Fuel Tank Capacity Tangki Minyak 油箱容量	0.65L
Spindle Size Saiz Spindel 主轴尺寸	M10 x 1.25LH
Dimensions (L x W x H) Dimensi 体积	400x325x395mm (15-3/4"x12-3/4"x15-1/2")
Net Weight Berat Bersih 净重	9.8kg (21.6lbs)

EE2650H 25.4mL 4-stroke

Petrol Edger

Pemotong Rumput Petrol
汽油草坪修边机



- **Plate on gear housing for protection against contact to concrete**
Plat pada gear untuk perlindungan daripada tersentuh konkrit
防止与混凝土接触的齿轮箱

Standard Equipment: Blade, Socket Wrench, Hex Wrench, Accessory Bag



Displacement Sesaran 排量	25.4mL
Engine Power Kuasa Enjin 发动机功率	0.77kW/ 1.1PS
Fuel Tank Capacity Tangki Minyak 油箱容量	0.6L
Dimensions (L x W x H) Dimensi 体积	1,773x242x315mm (69-3/4"x9-1/2"x12-3/8")
Net Weight Berat Bersih 净重	6.6kg (14.6lbs)

Cordless
Tempa Akuat Beker

LED Flashlight
Lampu Akuat LED
LED 闪光灯

Vacuum Cleaner
Penarik Vakum
吸尘器

Drilling / Fastening
Gergasi / Pengikat
电钻 / 螺絲

Impact Drilling / Demolition
Gergasi / Pengikat
电钻 / 螺絲

Cutting
Pemotong
切割

Grinding / Sanding
Pengisar / Poles
打磨 / 磨

Sawing
Gergasi
电锯

Planing / Routing
Pecutan / Tangkapan
刨 / 封边

Others
Lain-lain
其他

Outdoor Power Equipment
Alatan Kuasa Luar
户外动力设备

Makita
makita

OUTDOOR POWER EQUIPMENT

ETR2500 24.5mL

Petrol Edging Trimmer
Pemotong Rumput Petrol
汽油草坪修边机



- **Very powerful 2-stroke engine**
Enjin 2-strok yang berkuasa
强大的二冲程引擎

Standard Equipment: Single harness, Tool set



Displacement Sesaran 排量	24.5mL
Engine Power Kuasa Enjin 发动机功率	0.73kW/ 0.99PS
Fuel Tank Capacity Tangki Minyak 油箱容量	0.5L
Dimensions (L x W x H) Dimensi 体积	1,760x395x220mm (69-1/4"x15-1/2"x8-5/8")
Net Weight Berat Bersih 净重	5.1kg (12.1lbs)

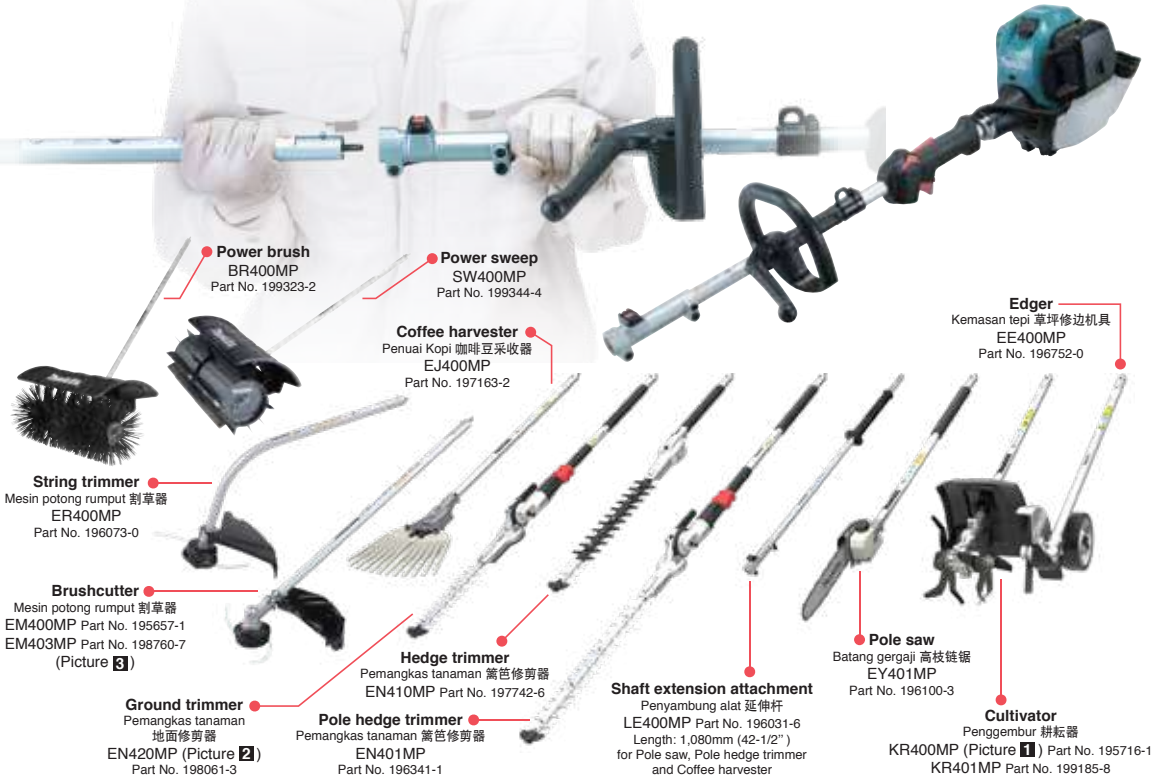

Power brush
BR400MP
Part No. 199323-2

Power sweep
SW400MP
Part No. 199344-4

Coffee harvester
Penuai Kopi 咖啡豆采收器
EJ400MP
Part No. 197163-2

String trimmer
Mesin potong rumput 割草器
ER400MP
Part No. 196073-0

Brushcutter
Mesin potong rumput 割草器
EM400MP Part No. 195657-1
EM403MP Part No. 198760-7
(Picture 3)

Ground trimmer
Pemangkas tanaman
地面修剪器
EN420MP (Picture 2)
Part No. 198061-3

Pole hedge trimmer
Pemangkas tanaman 篱笆修剪器
EN401MP
Part No. 196341-1

Hedge trimmer
Pemangkas tanaman 篱笆修剪器
EN410MP Part No. 197742-6

Shaft extension attachment
Penyambung alat 延伸杆
LE400MP Part No. 196031-6
Length: 1,080mm (42-1/2")
for Pole saw, Pole hedge trimmer
and Coffee harvester

Pole saw
Batang gergaji 高枝链锯
EY401MP
Part No. 196100-3

Edger
Kemasan tepi 草坪修边机具
EE400MP
Part No. 196752-0

Cultivator
Penggembur 耕耘器
KR400MP (Picture 1) Part No. 195716-1
KR401MP Part No. 199185-8

EX2650LHM 25.4mL 4-stroke

Multi Function Power Head
Powerhead Pelbagai Fungsi
多功能动力头



- **Makita Mini 4-Stroke motors offer cleaner exhaust emissions and reduced fuel consumption**
Motor Mini 4-Stroke Makita mengurangkan pelepasan asap dan penggunaan bahan api
Makita迷你四冲程马达降低废气排放和减少燃料消耗

Standard Equipment: Band Assembly, Socket Wrench, Hex Wrench, Oil (195500-4), Accessory Bag



Displacement Sesaran 排量	25.4mL
Engine Power Kuasa Enjin 发动机功率	0.77kW/ 1.1PS
Fuel Tank Capacity Tangki Minyak 油箱容量	0.6L
Dimensions (L x W x H) Dimensi 体积	975x323x241mm (38-3/8"x12-3/4"x9-1/2")
Net Weight Berat Bersih 净重	4.6kg (10lbs)

UC3551A 350mm (14") | UC4051A 400mm (16")

153

Electric Chain Saw
Gergaji Rantai
电链锯



- **Fast and efficient cutting**
Pemotongan cepat dan cekap
快速高效的切割

Standard Equipment: Saw Chain, Guide Bar, Guide Bar Cover, Hook Complete



Continuous Rating Input Input Kuasa Berterusan 额定输入功率	1,800W
Chain Speed per Minute Kelajuan Rantai 链条速度	870m (2,900ft)
Guide Bar Length Panjang Batang Gergaji 切割长度	350mm (14") UC3551A 400mm (16") UC4051A
Saw Chain Rantai 链条	Pitch : 3/8" Gauge : 1.3mm (0.050")
Dimensions (L x W x H) Dimensi 体积	505x200x220mm (19-7/8"x7-7/8"x8-5/8")
Net Weight Berat Bersih 净重	5.5kg (12.1lbs) UC3551A 5.6kg (12.3lbs) UC4051A
Power Supply Cord Kabel Wayar 电源线	0.3m (0.98ft)

Cordless
Terasa Bebas Kabel

LED Flashlight
Lampu Flash LED
LED 闪光灯

Vacuum Cleaner
Penyedut Vakuum
吸尘器

Drilling / Fastening
Gergaji / Penutup
电钻 / 螺絲

Impact Drilling / Demolition
Gergaji / Penutup
电钻 / 螺絲

Cutting
Pemotong
切割

Grinding / Sanding
Penggosok / Halus
打磨 / 磨光

Sawing
Gergaji
锯切

Planing / Routing
Penggosok / Halus
打磨 / 磨光

Others
Lain-lain
其他

Outdoor Power Equipment
Alatan Kuasa Luar
户外动力工具

Makita
MAKITA

OUTDOOR POWER EQUIPMENT

UC3541A 350mm (14") | UC4041A 400mm (16") 132

Electric Chain Saw

Gergaji Rantai
电链锯



- **Zero emissions and reduced maintenance**
Tanpa perlepasan asap & penyelenggaraan rendah
无排气及降低保养少维护

Standard Equipment: Saw Chain, Guide Bar, Guide Bar Cover, Hook Complete



Continuous Rating Input Input Kuasa Berterusan 额定输入功率	1,800W
Chain Speed per Minute Kelajuan Rantai 链条速度	870m (2,900ft)
Guide Bar Length Panjang Batang Gergaji 切割长度	350mm (14") UC3541A 400mm (16") UC4041A
Saw Chain Rantai 链条	Pitch : 3/8" Gauge: 1.1mm (0.043")/ 1.3mm (0.050")
Dimensions (L x W x H) Dimensi 体积	455x245x200mm (17-7/8"x9-5/8"x7-7/8")
Net Weight Berat Bersih 净重	4.7 - 4.9kg (10.4 - 10.6lbs)
Power Supply Cord Kabel Wayar 电源线	0.3m (0.98ft)

5016B 405mm (16") 153

Electric Chain Saw

Gergaji Rantai
电链锯



- **Compact and lightweight design**
Reka bentuk padat dan ringan
小巧轻便的设计

Standard Equipment: Saw Chain, Oil supply 100ml, Socket Wrench, File, Screwdriver



Continuous Rating Input Input Kuasa Berterusan 额定输入功率	1,300W
Chain Speed per Minute Kelajuan Rantai 链条速度	400m (1,310ft)
Guide Bar Length Panjang Batang Gergaji 切割长度	405mm (16")
Saw Chain Rantai 链条	Pitch : 3/8" Gauge: 1.3" or 0.050"
Overall Length Panjang Keseluruhan 总长度	750mm (29-1/2")
Net Weight Berat Bersih 净重	5.8kg (12.7lbs)
Power Supply Cord Kabel Wayar 电源线	5.0m (16.4ft)

EA3201S40B 400mm (16")

Petrol Chain Saw

Gergaji Rantai Petrol
汽油链锯



- **Touch & stop switch system keeps spark plug from getting wet**
Sistem suis mengelakkan palam cucuh daripada menjadi basah
可防止火花塞受潮的开关系统

Standard Equipment: Guide Bar, Saw Chain, Guide Bar Cover, Steel spike bumper, Socket Wrench, Screwdriver



Saw Chain Rantai 链条	Pitch : 3/8" Gauge: 1.1mm (0.043")/ 1.3mm (0.050")
Displacement Sesaran 排量	32mL
Engine Power Kuasa Enjin 发动机功率	1.35kW/ 1.9PS
Fuel Tank Capacity Tangki Minyak 油箱容量	0.4L
Chain Oil Tank Volume Tangki Minyak Pelincir 链油箱	0.28L
Dimensions (L x W x H) Dimensi 体积	405x269x273mm (16"x10-5/8"x10-3/4")
Power Head Weight Berat Kepala Kuasa 动力头重量	4.2kg (9.3lbs.)

EA3502S40B 400mm (16")

Petrol Chain Saw

Gergaji Rantai Petrol
汽油链锯

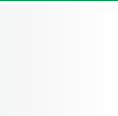

- **External access holes allow easy carburetor adjustment**
Lubang akses luar membolehkan pelarasan karburetor mudah
外部进入孔允许简单的化油器调整

Standard Equipment: Saw Chain, Guide bar, Guide Bar Cover, Socket Wrench, (+) Screwdriver



Saw Chain Rantai 链条	Pitch : 3/8" Gauge: 1.1mm (0.043")/ 1.3mm (0.050")
Displacement Sesaran 排量	35.0mL
Engine Power Kuasa Enjin 发动机功率	1.7kW/ 2.4PS
Fuel Tank Capacity Tangki Minyak 油箱容量	0.4L
Chain Oil Tank Volume Tangki Minyak Pelincir 链油箱	0.29L
Dimensions (L x W x H) Dimensi 体积	415x247x273mm (16-3/8"x9-3/4"x10-3/4")
Net Weight Berat Kepala Kuasa 动力头重量	4.4kg (9.7lbs)

EA4301F45B 450mm (18")

Petrol Chain Saw

Gergaji Rantai Petrol
汽油链锯



- **Increased output power**
Peningkatan kuasa output
增加输出功率

Standard Equipment: Saw Chain, Guide Bar, Guide Bar Cover, Socket Wrench, Hex Wrench, Screwdriver



Saw Chain Rantai 链条	Pitch : 0.325" or 3/8" Gauge: 1.3mm (0.050")
Displacement Sesaran 排量	42.4mL
Engine Power Kuasa Enjin 发动机功率	2.2kW/ 3.0PS
Fuel Tank Capacity Tangki Minyak 油箱容量	0.48L
Chain Oil Tank Volume Tangki Minyak Pelincir 链油箱	0.28L
Dimensions (L x W x H) Dimensi 体积	416x248x279mm (16-3/8"x9-3/4"x11")
Power Head Weight Berat Kepala Kuasa 动力头重量	4.8kg (10.5lbs.)

Cordless
Tanpa Ayat / 无线

LED Flashlight
Lampu Suluh LED
LED 电筒

Vacuum Cleaner
Penarik Vakuüm
吸尘器

Drilling / Fastening
Gergaji / Pengikat
电钻 / 螺絲

Impact Drilling / Demolition
Gergaji / Pengikat
电钻 / 螺絲

Cutting
Pensawang
切割

Grinding / Sanding
Pengisar / Pasir
打磨 / 砂纸

Sawing
Gergaji
电锯

Planing / Routing
Pegawai / Tangkapan
刨平 / 雕刻

Others
Lain-lain
其他

Outdoor Power Equipment
Alatan Kuasa Luar
户外动力工具

OUTDOOR POWER EQUIPMENT

EA6100P 600mm (24")

Petrol Chain Saw
Gergaji Rantai Petrol
汽油链锯



**STRATIFIED
SCAVENGING**

- Up to 20% less fuel consumption and lower emissions

Kurang penggunaan bahan api sehingga 20% dan pelepasan asap yang lebih rendah
燃料消耗降低20%，排放气降低



Standard Equipment: Saw Chain, Guide Bar Cover, Wrenches



Saw Chain Rantai 链条	Pitch : 0.325 or 3/8"
Displacement Sesaran 排量	60.7mL
Engine Power Kuasa Enjin 发动机功率	3.4kW/ 4.6PS
Fuel Tank Capacity Tangki Minyak 油箱容量	0.8L
Chain Oil Tank Volume Tangki Minyak Pelincir 链油箱	0.48L
Dimensions (L x W x H) Dimensi 体积	435x243x312mm (17-1/8"x9-9/16"x12-1/4")
Power Head Weight Berat Kepala Kuasa 动力头重量	6.0kg (13.2lbs.)

EA7900P70E 600mm (24")

Petrol Chain Saw
Gergaji Rantai Petrol
汽油链锯



**SCAVENGING
LOSSES REJECTION**

- Adjustable automatic chain lubrication with large oil reservoir
- Pelarasan pelinciran rantai automatik dengan takungan minyak yang besar
可调自动链条润滑



Standard Equipment: Saw Chain, Guide Bar, Guide Bar Cover, Socket Wrench



Saw Chain Rantai 链条	Pitch : 3/8"
Displacement Sesaran 排量	Gauge: 1.5mm (0.058") 79mL
Engine Power Kuasa Enjin 发动机功率	4.3kW/ 5.8PS
Fuel Tank Capacity Tangki Minyak 油箱容量	0.75L
Chain Oil Tank Volume Tangki Minyak Pelincir 链油箱	0.42L
Power Head Weight Berat Kepala Kuasa 动力头重量	6.3kg (13.8lbs.)

DCS520-53 530mm (21")

Petrol Chain Saw
Gergaji Rantai Petrol
汽油链锯



- Automatic adjustable chain oiler
- Pelarasan minyak rantai automatik
自动调节链条油



Standard Equipment: Saw Chain, Guide Bar Cover, Wrenches



Saw Chain Rantai 链条	Pitch : 3/8"
Displacement Sesaran 排量	Gauge: 1.5mm (0.058") 52mL
Power Rating Kuasa Enjin 发动机功率	2.4kW
Fuel Tank Capacity Tangki Minyak 油箱容量	0.56L
Chain Oil Tank Volume Tangki Minyak Pelincir 链油箱	0.28L
Power Head Weight Berat Kepala Kuasa 动力头重量	4.5kg (9.9lbs.)

DCS6401-50 500mm (20")

Petrol Chain Saw
Gergaji Rantai Petrol
汽油链锯



- Vibration damping with tough, long-life steel springs
- Getaran redaman dengan pegas keluli yang tahan lama
减震，坚韧，而持久的钢弹簧



Standard Equipment: Saw Chain, Guide Bar Cover, Wrenches



Saw Chain Rantai 链条	Pitch : 3/8"
Displacement Sesaran 排量	Gauge: 1.5mm (0.058") 64mL
Engine Power Kuasa Enjin 发动机功率	3.5kW/ 4.8PS
Fuel Tank Capacity Tangki Minyak 油箱容量	0.75L
Chain Oil Tank Volume Tangki Minyak Pelincir 链油箱	0.42L
Power Head Weight Berat Kepala Kuasa 动力头重量	6.3kg (13.89lbs.)

DCS7301-60 600mm (24")

Petrol Chain Saw
Gergaji Rantai Petrol
汽油链锯



- Improved air filtration through the Air master air filter system
- Penapis udara yang lebih baik
改进的空气过滤系统改善空气过滤



Standard Equipment: Saw Chain, Guide Bar Cover, Wrenches



Saw Chain Rantai 链条	Pitch : 3/8"
Displacement Sesaran 排量	Gauge: 1.5mm (0.058") 72.6mL
Engine Power Kuasa Enjin 发动机功率	4.2kW/ 5.7PS
Fuel Tank Capacity Tangki Minyak 油箱容量	0.75L
Chain Oil Tank Volume Tangki Minyak Pelincir 链油箱	0.42L
Power Head Weight Berat Kepala Kuasa 动力头重量	6.3kg (13.89lbs.)

Cordless
Terasa Bantu Beraksi

LED Flashlight
Lampu Bantu LED
LED BERTAMBAH

Vacuum Cleaner
Pembersih Vakuum

Drilling / Fastening
Gergaji / Penambat
MILIKI / BERTAMBAH

Impact Drilling / Demolition
Gergaji / Penambah
Gergaji / Hancurkan

Cutting
Pemotong

Grinding / Sanding
Penggosok / Haluskan
Gergaji / Hancurkan

Sawing
Gergaji

Planing / Routing
Penggosok / Tergosok
Gergaji / Hancurkan

Others
Lain-lain
MILIKI

Outdoor Power Equipment
Alatan Kuasa Luar
MILIKI / BERTAMBAH

Makita
MILIKI

OUTDOOR POWER EQUIPMENT

DCS7901-70 700mm (28")

Petrol Chain Saw

Gergaji Rantai Petrol
汽油链锯



- Improved air filtration through the Air master air filter system
Penapis udara yang lebih baik
改进的空气过滤系统改善空气过滤

Standard Equipment: Saw Chain, Guide Bar Cover, Wrenches



Saw Chain Rantai 链条	Pitch : 3/8" Gauge: 1.5mm (0.058")
Displacement Sesaran 排量	78.5mL
Engine Power Kuasa Enjin 发动机功率	4.6kW/ 6.3PS
Fuel Tank Capacity Tangki Minyak 油箱容量	0.75L
Chain Oil Tank Volume Tangki Minyak Pelincir 链油箱	0.42L
Power Head Weight Berat Kepala Kuasa 动力头重量	6.3kg (13.89lbs.)

DCS9010-76 740mm (29")

Petrol Chain Saw

Gergaji Rantai Petrol
汽油链锯



- Heavy timber saw for the hardest working for professionals
Gergaji kayu berat untuk profesional
适合专业人员的重型木锯

Standard Equipment: Saw Chain, Guide Bar Cover, Wrench, Screwdriver



Saw Chain Rantai 链条	Pitch : 3/8" Gauge: 1.5mm (0.058")
Displacement Sesaran 排量	90mL
Engine Power Kuasa Enjin 发动机功率	4.9kW/ 6.7PS
Fuel Tank Capacity Tangki Minyak 油箱容量	1L
Chain Oil Tank Volume Tangki Minyak Pelincir 链油箱	0.4L
Power Head Weight Berat Kepala Kuasa 动力头重量	8.2kg (18.1lbs.)

EA3110T30B 300mm (12")

Petrol Chain Saw

Gergaji Rantai Petrol
汽油链锯



- Compact and lightweight body for better handling
Padat dan ringan
小巧轻便的机身易于操纵

Standard Equipment: Guide Bar, Saw Chain, Guide Bar Cover, Socket Wrench, Screwdriver



WHILE STOCK LAST
Sementara stok masih ada
有限库存

Saw Chain Rantai 链条	Pitch : 3/8" Gauge: 1.3mm (0.050")
Displacement Sesaran 排量	30.1mL
Engine Power Kuasa Enjin 发动机功率	1.0kW/ 1.4PS
Fuel Tank Capacity Tangki Minyak 油箱容量	0.24L
Chain Oil Tank Volume Tangki Minyak Pelincir 链油箱	0.18L
Dimensions (L x W x H) Dimensi 体积	259x236x217mm (10-1/4"x9-1/4"x8-1/2")
Power Head Weight Berat Kepala Kuasa 动力头重量	3.2kg (7.0lbs.)

DCS231T 250mm (10")

Petrol Chain Saw

Gergaji Rantai Petrol
汽油链锯

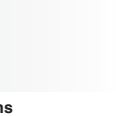

- Fast acceleration and low emissions
Pelepasan asap yang rendah
低排气

Standard Equipment: Saw Chain, Guide Bar, Guide Bar Cover, Wrench 13-16



Bar Length Panjang Batang Gergaji 切割长度	25cm
Displacement Sesaran 排量	22.2mL
Engine Power Kuasa Enjin 发动机功率	0.74kW
Fuel Tank Capacity Tangki Minyak 油箱容量	0.2L
Chain Oil Tank Volume Tangki Minyak Pelincir 链油箱	0.19L
Power Head Weight Berat Kepala Kuasa 动力头重量	2.5kg

EA5600F53G 530mm (21")

Petrol Chain Saw

Gergaji Rantai Petrol
汽油链锯



- Excellent air filter system for reduced maintenance
Sistem penapis udara yang sangat baik untuk mengurangkan penyelenggaraan
卓越的空气过滤系统，减少维修

Standard Equipment: Saw Chain, Guide Bar, Guide Bar Cover, Socket Wrench



Saw Chain Rantai 链条	Pitch : 3/8" or 0.325" Gauge: 1.3mm (0.050")/ 1.5mm (0.058")
Displacement Sesaran 排量	55.7mL
Engine Power Kuasa Enjin 发动机功率	3.0kW/ 4.1PS
Fuel Tank Capacity Tangki Minyak 油箱容量	0.6L
Chain Oil Tank Volume Tangki Minyak Pelincir 链油箱	0.3L
Dimensions (L x W x H) Dimensi 体积	430x237x297mm (17"x9-3/8"x11-5/8")
Power Head Weight Berat Kepala Kuasa 动力头重量	5.8kg (12.8lbs.)

Cordless
Tempa Akuat 充电式

LED Flashlight
Lampu Akuat LED
LED 充电式

Vacuum Cleaner
Penarik Akuat
吸尘器

Drilling / Fastening
Gergaji / Pengikat
电钻 / 紧固件

Impact Drilling / Demolition
Gergaji / Penanggal
电钻 / 拆除

Cutting
Penanggal
切割

Grinding / Sanding
Pengisar / Pasir
打磨 / 砂纸

Sawing
Gergaji
锯切

Planing / Routing
Pecutan / Tangkapan
刨平 / 雕刻

Others
Lain-lain
其他

Outdoor Power Equipment
Alatan Kuasa Luar
户外动力设备

Makita
makita

OUTDOOR POWER EQUIPMENT

EY2650H25H 25.4mL 4-stroke

Telescopic Petrol Pole Saw
Rantai Cawangan Teleskopik Tinggi
伸缩式高枝链锯



- Ideal for pruning and limbing in tall trees or hard to reach areas
Sesuai untuk pemangkasan pokok-pokok yang tinggi
适合修剪和砍伐高大树木

Standard Equipment: Blade Cover, Tool set, Oil set



Displacement Sesaran 排量	25.4mL
Engine Power Kuasa Enjin 发动机功率	0.77kW/ 1.1PS
Fuel Tank Capacity Tangki Minyak 油箱容量	0.6L
Guide Bar Length Panjang Batang Gergaji 切割长度	255mm (10")
Saw Chain Rantai 链条	Gauge: 1.3mm (0.050") Pitch: 3/8"
Dimensions (L x W x H) Dimensi 体积	2,720x223x240mm (107"x8-3/4"x9-1/2")
Net Weight Berat Bersih 净重	7.2kg (16.0lbs)

UH7580X 750mm (29-1/2")

419

Electric Hedge Trimmer
Pemangkas Tanaman Pagar
电篱笆修剪机



- Powerful 670W motor
Motor berkuasa 670W
强劲的670W电机

Standard Equipment: Blade Cover, Hook complete, Belt Hook



Continuous Rating Input Input Kuasa Berterusan 额定输入功率	670W
Blade Length Panjang Bilah 锯片长度	750mm (29-1/2")
Strokes Per Minute (SPM) Kelajuan Strok 冲程速度	3,000
Tooth Spacing Selang Gigi 牙齿间隔	18mm (11/16")
Net Weight Keberatan 净重	4.4kg (9.7lbs.)
Power Supply Cord Kabel Wayar 电源线	0.3m (0.98ft)

EH7500SX 750mm (29-1/2")

Petrol Hedge Trimmer
Pemangkas Tanaman Pagar Petrol
汽油篱笆修剪机



CATALYTIC CONVERTER

- Blade teeth with 3 sharpened edges
Bilah gigi dengan 3 ketajaman
有3个锋利边缘的刀刃

Standard Equipment: Blade Cover, Socket Wrench, Hex Wrench



Blade Length Panjang Bilah 锯片长度	750mm (29-1/2")
Displacement Sesaran 排量	22.2mL
Engine Power Kuasa Enjin 发动机功率	0.68kW/ 1.0PS
Fuel Tank Capacity Tangki Minyak 油箱容量	0.4L
Strokes Per Minute (SPM) Kelajuan Strok 冲程速度	4390
Tooth Spacing Selang Gigi 牙齿间隔	35mm (1-3/8")
Dimensions (L x W x H) Dimensi 体积	1,150x323x212mm (45-1/4"x12-3/4"x8-3/8")
Net Weight Berat Bersih 净重	4.9kg (10.8lbs)

EH6000W 600mm (23-5/8")

Petrol Hedge Trimmer
Pemangkas Tanaman Pagar Petrol
汽油篱笆修剪机



CATALYTIC CONVERTER

- The lightest 22.2cc petrol hedge trimmer with double-sided blade
Trimmer petrol yang paling ringan dengan bilah dua sisi
最轻的22.2cc双面刀片汽油绿篱机

Standard Equipment: Blade Cover, Socket Wrench, Hex Wrench



Blade Length Panjang Bilah 锯片长度	600mm (23-5/8")
Displacement Sesaran 排量	22.2mL
Engine Power Kuasa Enjin 发动机功率	0.68kW/ 1.0PS
Fuel Tank Capacity Tangki Minyak 油箱容量	0.4L
Strokes Per Minute (SPM) Kelajuan Strok 冲程速度	4390
Tooth Spacing Selang Gigi 牙齿间隔	35mm (1-3/8")
Dimensions (L x W x H) Dimensi 体积	1,119x262x216mm (44"x10-3/8"x8-1/2")
Net Weight Berat Bersih 净重	5kg (11lbs)

EH5000W 500mm (19-3/4")

Petrol Hedge Trimmer
Pemangkas Tanaman Pagar Petrol
汽油篱笆修剪机



CATALYTIC CONVERTER

- Rotatable handle is convenient for various style operation
Pemegang berputar mudah untuk pelbagai operasi
可旋转的手柄方便各种操作

Standard Equipment: Blade Cover, Socket Wrench, Hex Wrench



Blade Length Panjang Bilah 锯片长度	500mm (19-3/4")
Displacement Sesaran 排量	22.2mL
Engine Power Kuasa Enjin 发动机功率	0.68kW/ 1.0PS
Fuel Tank Capacity Tangki Minyak 油箱容量	0.4L
Strokes Per Minute (SPM) Kelajuan Strok 冲程速度	4390
Tooth Spacing Selang Gigi 牙齿间隔	35mm (1-3/8")
Dimensions (L x W x H) Dimensi 体积	1,014x262x216mm (40"x10-3/8"x8-1/2")
Net Weight Berat Bersih 净重	4.8kg (10.5lbs)

Cordless
Terasa Boleh Terus
LED Flashlight
Lampu Flash LED
Vacuum Cleaner
Pembersih Vakuum
Drilling / Fastening
Gergaji / Pasang
Impact Drilling / Demolition
Gergaji / Hancurkan
Cutting
Memotong
Grinding / Sanding
Menggosok / Haluskan
Sawing
Memotong
Planing / Routing
Penghalus / Mengukir
Others
Lain-lain

Outdoor Power Equipment
Alatan Kuasa Luar
Makita
19100

OUTDOOR POWER EQUIPMENT

HTR7610 750mm (29-1/2")

Petrol Hedge Trimmer
Pemangkas Tanaman Pagar Petrol
汽油篱笆修剪机



- **Wide-trigger control and soft grip for comfortable operation**
Pencetus dan genggaman lembut untuk operasi yang selesa
宽触发控制和柔软的握柄舒适操作

Standard Equipment: Blade Cover, Tool set



sementara stok masih ada 售完即止
WHILE STOCK LAST



Blade Length Panjang Bilah 锯片长度	750mm (29-1/2")
Displacement Sesaran 排量	24.5mL
Engine Power Kuasa Enjin 发动机功率	0.73kW/ 0.99PS
Fuel Tank Capacity Tangki Minyak 油箱容量	0.6L
Dimensions (L x W x H) Dimensi 体积	1,041x280x258mm (41"x11"x10-1/8")
Strokes Per Minute (SPM) Kelajuan Strok 冲程速度	3,600
Net Weight Berat Bersih 净重	5.4kg (11.9lbs)

HTR5600 560mm (22")

Petrol Hedge Trimmer
Pemangkas Tanaman Pagar Petrol
汽油篱笆修剪机



- **Very powerful 2-stroke engine**
Enjin 2-strok yang berkuasa
强大的二冲程引擎

Standard Equipment: Blade Cover, Tool set



sementara stok masih ada 售完即止
WHILE STOCK LAST



Blade Length Panjang Bilah 锯片长度	560mm (22")
Displacement Sesaran 排量	24.5mL
Engine Power Kuasa Enjin 发动机功率	0.73kW/ 0.99PS
Fuel Tank Capacity Tangki Minyak 油箱容量	0.6L
Tooth Spacing Selang Gigi 牙齿间隔	28mm (1-1/8")
Dimensions (L x W x H) Dimensi 体积	840x246x225mm (33"x9-11/16"x8-7/8")
Strokes Per Minute (SPM) Kelajuan Strok 冲程速度	3,600
Net Weight Berat Bersih 净重	5.1kg (11.2lbs)

EN4951SH 25.4mL 4-stroke

Petrol Pole Hedge Trimmer
Pemangkas Tanaman Pagar
Tinggi Petrol
汽油高枝篱笆剪

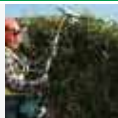

- **Can be folded in the 180° position for easy transport and storage**
Boleh dilipat di kedudukan 180° untuk memudahkan pengangkutan dan penyimpanan
可以在180°的位置折叠，便于运输和储存

Standard Equipment: Blade Cover, Socket Wrench, Hex Wrench, Band Assembly

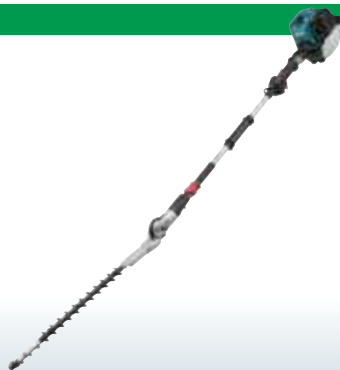

Displacement Sesaran 排量	25.4mL
Engine Power Kuasa Enjin 发动机功率	0.77kW/ 1.1PS
Fuel Tank Capacity Tangki Minyak 油箱容量	0.6L
Strokes Per Minute (SPM) Kelajuan Strok 冲程速度	4,200
Blade Length Panjang Batang Gergaji 切割长度	490mm (19-1/4")
Dimensions (L x W x H) Dimensi 体积	2,050x221x241mm (80-1/2"x8-3/4"x8-1/2")
Net Weight Berat Bersih 净重	6.6kg (14.6lbs)

PTR2500 24.5mL

Petrol Pole Trimmer
Pemangkas Tanaman Pagar
Tinggi Petrol
汽油高枝篱笆剪



- **Very powerful 2-stroke engine**
Enjin 2-strok yang berkuasa
强大的二冲程引擎

Standard Equipment: Band Assembly, Accessory Bag, Tool Set, Wrench, Safety Goggles



Displacement Sesaran 排量	24.5mL
Engine Power Kuasa Enjin 发动机功率	0.73kW/ 0.99PS
Fuel Tank Capacity Tangki Minyak 油箱容量	0.65L
Dimensions (L x W x H) Dimensi 体积	2,400x350x220mm (94-1/2"x13-3/4"x8-5/8")
Net Weight Berat Bersih 净重	6.1kg (13.4lbs)

EB7660TH 75.6mL 4-Stroke

Petrol Blower
Mesin Peniup Petrol
背负式汽油吹风机



- **Powerful fuel efficient 75.6mL MM4 commercial duty engine**
Enjin MM4 komersial 75.6mL yang cekap
强力工业用途四冲程吹风机

Standard Equipment: Oil (195532-1), Socket Wrench, Driver, Flexible Pipe, Swivel Pipe, Hose Clamp, End Nozel, Flat Nozzle, Long Pipe, Short Pipe, Cable Holder, Accessory Bag



Displacement Sesaran 排量	75.6mL
Power Rating Kuasa 额定功率	3.0kW (4.1PS)
Max Air Volume Isipadu Angin Maksimum 最大风量	20m³/min (706CFM)
Max Air Velocity Velositi Angin Maksimum 最大风速	92m/s (205MPH)
Fuel Tank Capacity Tangki Minyak 油箱容量	1.9L (64oz.)
No Load Speed (RPM) Kelajuan Tanpa Beban 回转速	2,800 - 7,200
Max Torque Pemutaran Tenaga Maksimum 最大扭矩	4.7N·m
Dimensions (L x W x H) Dimensi 体积	332x460x480mm (13-1/8"x18-1/8"x18-7/8")
Net Weight Berat Bersih 净重	11.9 - 12.1kg (26.2 - 26.7lbs.)

Cordless
Tempa Akuat BATERAI

LED Flashlight
Lampu Akuat LED
LTC088812

Vacuum Cleaner
Penarik Akuat
VAC030

Drilling / Fastening
Gergaji / Pengikat
METS / 螺絲

Impact Drilling / Demolition
Gergaji / 敲擊
METS / 螺絲

Cutting
Penapis
METS / 螺絲

Grinding / Sanding
Gergaji / 磨
METS / 螺絲

Sawing
Gergaji
METS / 螺絲

Planing / Routing
Pegyalan / Tangkapan
METS / 螺絲

Others
Lain-lain
METS / 螺絲

Outdoor Power Equipment
Alatan Akuat
METS / 螺絲

Outdoor Power Equipment
Alatan Akuat
METS / 螺絲

Makita
METS / 螺絲

OUTDOOR POWER EQUIPMENT

EB5300TH 52.5mL 4-Stroke

Petrol Blower
Mesin Peniup Petrol
背负式汽油吹风机



- Heavy duty anti-vibration mounts between frame and engine for improved operator comfort
Bertugas berat dan anti getaran
强力，低振动和舒适的设计

Standard Equipment: Oil (198279-6), Box Wrench, Driver, Flexible Pipe, Swivel Pipe, Hose Clamp, End Nozzle, Flat Nozzle, Long Pipe, Short Pipe, Cable Holder, Accessory Bag



VIDEO CLIP
Models and specs may vary by country



Displacement Sesaran 排量	52.5mL
Power Rating Kuasa 额定功率	1.8kW (2.5PS)
Max Air Volume Isipadu Angin Maksimum 最大风量	15m ³ /min (516CFM)
Max Air Velocity Velositi Angin Maksimum 最大风速	98m/s (220MPH)
Fuel Tank Capacity Tangki Minyak 油箱容量	1.8L (61oz.)
No Load Speed (RPM) Kelajuan Tanpa Beban 回转速数	2,800 - 6,400
Max Torque Pemutaran Tenaga Maksimum 最大扭力	3.0N·m
Dimensions (L x W x H) Dimensi 体积	320x450x475mm (12-5/8"x17-3/4"x18-3/4")
Net Weight Berat Bersih 净重	8.9kg (19.7lbs.)

BHX2500 24.5mL 4-stroke

Petrol Blower
Mesin Peniup Petrol
汽油吹风机



- 4-stroke engine requires no fuel mix. 4-stroke for low noise and low emission
Enjin 4 strok tidak perlu campuran minyak, bunyi rendah dan perlepasan asap rendah
四冲程引擎，无需混合燃料，低噪音，无排气

Standard Equipment: Pipe, Nozzle, Socket Wrench



Displacement Sesaran 排量	24.5mL
Power Rating Kuasa 额定功率	0.81kW
Max Air Volume Isipadu Angin Maksimum 最大风量	10.1m ³ /min (356CFM)
Max Air Velocity Velositi Angin Maksimum 最大风速	65m/s (145MPH)
Fuel Tank Capacity Tangki Minyak 油箱容量	0.52L (17.6oz.)
No Load Speed (RPM) Kelajuan Tanpa Beban 回转速数	3,500 - 7,800
Dimensions (L x W x H) Dimensi 体积	350x231x368mm (13.8"x9.1"x14.5")
Net Weight Berat Bersih 净重	4.5kg (9.8lbs)

Powerful spray range up to 16m (52ft) horizontally

Penyembur yang berkuasa tinggi boleh menyembur sampai 16m (52ft) secara mendatar 强力喷雾系列，距离长达 16m (52英尺)

Mosquito Spray Nozzles Part No. 196499-6 (Optional Accessories)

For users consider to reduce risk of getting disease from mosquito, the best option is using Makita Petrol Mist Blower with mosquito spray nozzle accessories.

Muncung penyembur untuk mengurangkan nyamuk
Untuk pengguna yang ingin mengurangkan risiko jangkitan dari nyamuk yang berpenyakit, pilihan yang terbaik adalah menggunakan Petrol Penyembur Makita dengan aksesori muncung penyembur nyamuk.

为降低蚊子疾病感染的风险，Makita 汽油喷雾机与蚊子喷嘴配件的搭配是最佳选择。

PM7650H 75.6mL 4-stroke

Mist Blower
Penyembur Petrol
汽油喷雾器



Mosquito Spray Nozzles
Part No. 196499-6 (Optional Accessories)

- Excellent spray range performance up to 16m (52 ft) horizontally
Semburan yang berprestasi tinggi sehingga 16m (52 kaki) secara mendatar
优秀的喷射性能水平置高达 16米(52英尺)

Standard Equipment: Hand Strap, Screwdriver, Diffusion Cover, Hose Clamp, Flexible Pipe, Straight Pipe



Displacement Sesaran 排量	75.6mL
Fuel Tank Capacity Tangki Minyak 油箱容量	1.8L
Max Air Volume Isipadu Angin Maksimum 最大风量	14.1m ³ /min (497CFM) The velocity of the wind (w/o blower pipes) 85m/s
Dimensions (L x W x H) Dimensi 体积	420x440x595mm (16-1/2"x17-1/4"x23-1/2")
Net Weight Keberatan 净重	13.9kg (30.6lbs)

Cordless
Tangan Boleh Diguna

LED Flashlight
Lampu Flash LED
LED BUKU

Vacuum Cleaner
Penarik Asap
吸尘器

Drilling / Fastening
Gergaji / Penutup
电钻 / 螺絲

Impact Drilling / Demolition
Gergaji / Penutup
电钻 / 螺絲

Cutting
Penutup
电锯

Grinding / Sanding
Penutup / Hujung
电磨 / 电砂

Sawing
Gergaji
电锯

Planing / Routing
Penutup / Hujung
电刨 / 电修

Others
Lain-lain
其他

Outdoor Power Equipment
Alatan Kraf Luar
户外动力设备

Makita
MAKITA

OUTDOOR POWER EQUIPMENT

ELM4121 410mm (16-1/8")

Electric Lawn Mower

Mesin Pemotong Rumput
电手推割草机

- **Robust steel cutting deck for increased durability**
Dek keluli memotong untuk meningkat ketahanan
钢制切割台提高其耐用性

Standard Equipment: Blade, Wrench, Mulch Plug



Continuous Rating Input Input Kuasa Berterusan 额定输入功率	1,600W
Hole Diameter Diameter Lubang 孔直径	8mm (5/16")
Cutting Width Lebar Keratan 切割宽度	410mm (16-1/8")
Cutting Height Ketinggian Pemotongan 切割高度	20 - 75mm (13/16" - 2-15/16")
No Load Speed (RPM) Kelajuan Tanpa Beban 回转数	3,400
Recommended mowing area up to Julat Memotong yang Disyorkan 推荐的割草范围	600m ²
Grass Box Capacity Kapasiti Kotak Rumput 草箱容量	50L
Wheel Size Saiz Roda 轮片尺寸	Front / Rear: 156 / 200mm (6-1/8 / 7-7/8")
Dimensions (L x W x H) Dimensi 体积	1,465x530x905-1,135mm (57-3/4"x20-7/8"x35-5/8" - 44-3/4")
Net Weight Berat Bersih 净重	17.5 - 19.1kg (38.6 - 42.1lbs.)

ELM3720 370mm (14-1/2")

Electric Lawn Mower

Mesin Pemotong Rumput
电手推割草机

- **Stays upright for easy maintenance and cleaning**
Penyelenggaraan dan pembersihan lebih mudah
简单维护和清洁

Standard Equipment: Blade, Wrench



Continuous Rating Input Input Kuasa Berterusan 额定输入功率	1,400W
Hole Diameter Diameter Lubang 孔直径	8mm (5/16")
Cutting Width Lebar Keratan 切割宽度	370mm (14-1/2")
Cutting Height Ketinggian Pemotongan 切割高度	20 - 55mm (13/16" - 2-3/16")
No Load Speed (RPM) Kelajuan Tanpa Beban 回转数	3,400
Recommended mowing area up to Julat Memotong yang Disyorkan 推荐的割草范围	500m ²
Grass Box Capacity Kapasiti Kotak Rumput 草箱容量	40L
Wheel Size Saiz Roda 轮片尺寸	Front / Rear: 139 / 178mm (5-1/2 / 7")
Dimensions (L x W x H) Dimensi 体积	1,330x415x890-1,120mm (52-3/8"x16-3/8"x35" - 44")
Net Weight Berat Bersih 净重	11.6kg (25.6lbs.)

ELM3711X 370mm (14-1/2")

Electric Lawn Mower

Mesin Pemotong Rumput
电手推割草机

- **Silent and NO emission**
Senyap dan tanpa perlepasan asap
低噪音, 无排气

Standard Equipment: Blade



Continuous Rating Input Input Kuasa Berterusan 额定输入功率	1,400W
Cutting Width Lebar Keratan 切割宽度	370mm (14-1/2")
Cutting Height Ketinggian Pemotongan 切割高度	20,40,55mm (13/16, 1-9/16, 2-3/16")
No Load Speed (RPM) Kelajuan Tanpa Beban 回转数	2,900
Recommended Mowing Area up to Julat memotong yang disyorkan 推荐的割草范围	500m ²
Grass Box Capacity Kapasiti Kotak Rumput 草箱容量	35L
Dimensions (L x W x H) Dimensi 体积	662x412x312mm (26"x16-1/2"x12-5/8")
Net Weight Berat Bersih 净重	14.8kg (32.6lbs)

ELM3320 330mm (13")

Electric Lawn Mower

Mesin Pemotong Rumput
电手推割草机

- **Stays upright for easy maintenance and cleaning**
Penyelenggaraan dan pembersihan lebih mudah
简单维护和清洁

Standard Equipment: Blade, Wrench



Continuous Rating Input Input Kuasa Berterusan 额定输入功率	1,200W
Hole Diameter Diameter Lubang 孔直径	8mm (5/16")
Cutting Width Lebar Keratan 切割宽度	330mm (13")
Cutting Height Ketinggian Pemotongan 切割高度	20 - 55mm (13/16" - 2-3/16")
No Load Speed (RPM) Kelajuan Tanpa Beban 回转数	3,400
Recommended mowing area up to Julat Memotong yang Disyorkan 推荐的割草范围	400m ²
Grass Box Capacity Kapasiti Kotak Rumput 草箱容量	30L
Wheel Size Saiz Roda 轮片尺寸	Front / Rear: 139 / 178mm (5-1/2 / 7")
Dimensions (L x W x H) Dimensi 体积	1,230x380x870-1,110mm (48-1/2"x15"x34-1/4" - 43-3/4")
Net Weight Berat Bersih 净重	10.2kg (22.5lbs.)

ELM3311X 330mm (13")

Electric Lawn Mower

Mesin Pemotong Rumput
电手推割草机

- **Wheels tucked under body to enhance performance**
Roda bawah badan mesin untuk meningkatkan prestasi
轮子隐藏在机身下提高性能



Continuous Rating Input Input Kuasa Berterusan 额定输入功率	1,100W
Cutting Width Lebar Keratan 切割宽度	330mm (13")
Cutting Height Ketinggian Pemotongan 切割高度	20,40,55mm (13/16, 1-9/16, 2-3/16")
No Load Speed (RPM) Kelajuan Tanpa Beban 回转数	2,900
Recommended Mowing Area up to Julat memotong yang disyorkan 推荐的割草范围	400m ²
Grass Box Capacity Kapasiti Kotak Rumput 草箱容量	27L
Dimensions (L x W x H) Dimensi 体积	621x376x312mm (24-1/2"x14-3/4"x12-1/4")
Net Weight Berat Bersih 净重	13.0kg (28.7lbs)

Cordless
Tempa Akuat 充电

LED Flashlight
Lampu Akuat LED
LED 闪光灯

Vacuum Cleaner
Penarik Akuat
吸尘器

Drilling / Fastening
Gergasi / Pengikat
电钻 / 螺絲

Impact Drilling / Demolition
Gergasi / Hancurkan
电钻 / 破坏

Cutting
Pemotong
切割

Grinding / Sanding
Pengisar / Hancur
打磨 / 打磨

Sawing
Gergasi
电锯

Planing / Routing
Pegyalan / Tonggolan
刨平 / 刨花

Others
Lain-lain
其他

Outdoor Power Equipment
Alatan Akuat Luar
户外动力设备

Makita
makita

OUTDOOR POWER EQUIPMENT

PLM5120N2 | PLM5120 510mm (20")

Petrol Lawn Mower
Mesin Pemotong Rumput Petrol
汽油手推割草机

- 4-stroke engine requires no fuel mix
Enjin 4 strok tidak perlu campuran minyak
四冲程引擎，无需混合燃料

Standard Equipment: Blade, Box Wrench,
Side Discharge Channel



PLM5120N2 ▶



PLM5120
Sembarang stok, mesin 80cc 售完即止
WHILE STOCK LAST

Engine Enjin 发动机	B&S625E R/S, 150mL PLM5120N2 B&S625E, 190mL PLM5120
Engine Power Kuasa Enjin 发动机功率	2.2kW/ N/A PS
Cutting Width Lebar Keratan 切割宽度	510mm (20")
Cutting Height Ketinggian Pemotongan 切割高度	25 - 70mm (1" - 2-3/4")
No Load Speed (RPM) Kelajuan Tanpa Beban 回转数	2,800
Recommended Mowing Area up to Julat Memotong yang Disyorkan 推荐的割草范围	1,500m ² PLM5120N2 2,200m ² PLM5120
Fuel Tank Capacity Tangki Minyak 油箱容量	0.8L (N/A oz.) PLM5120N2 1.0L (N/A oz.) PLM5120
Oil Tank Capacity Kapasiti Tangki Minyak 润滑油箱	0.47L (N/A oz.) PLM5120N2
Dimensions (L x W x H) Dimensi 体积	850x560x375mm (33-1/2"x22"x14-3/4") PLM5120N2 800x550x380mm (31-1/2"x21-5/8"x15") PLM5120
Net Weight Berat Bersih 净重	25.5kg (57.3lbs.) PLM5120N2 28kg (61.7lbs.) PLM5120

PLM4620N2 460mm (18-1/8")

Petrol Lawn Mower
Mesin Pemotong Rumput Petrol
汽油手推割草机

- Brake for maximum productivity and increased operator safety
Brek untuk produktiviti maksimum dan keselamatan pengguna
电刹车器增加使用者的安全

Standard Equipment: Blade, Box Wrench, Mulch plug



Engine Enjin 发动机	B&S625E R/S, 150mL
Engine Power Kuasa Enjin 发动机功率	2.2kW/ N/A PS
Cutting Width Lebar Keratan 切割宽度	460mm (18-1/8")
Cutting Height Ketinggian Pemotongan 切割高度	25 - 70mm (1" - 2-3/4")
No Load Speed (RPM) Kelajuan Tanpa Beban 回转数	2,800
Recommended Mowing Area up to Julat Memotong yang Disyorkan 推荐的割草范围	1,200m ²
Grass Box Capacity Kapasiti Kotak Rumput 草箱容量	60L
Fuel Tank Capacity Tangki Minyak 油箱容量	Fuel: 0.8L (N/A oz.) Oil: 0.47L (N/A oz.)
Dimensions (L x W x H) Dimensi 体积	800x540x400mm (31-1/2"x21-1/4"x15-3/4")
Net Weight Berat Bersih 净重	27.6kg (60.9lbs.)

EK7651H / X1 355mm (14")

Power Cutter
Pemotong Berkuasa
汽油切断机



- Save cost of the power cutter with fuel savings alone
Kos operasi yang rendah
节省燃油

- X1: Come with Diamond Wheel (B-13465), Oil (195532-D)



VIDEO CLIP
Models and specs may vary by country



Wheel Diameter Diameter Roda 轮片直径	355mm (14")
Engine Enjin 发动机	75.6mL
Max Cutting Depth Kedalaman Pemotongan Maksimum 最大切割深度	122mm (4-13/16")
No Load Speed (RPM) Kelajuan Tanpa Beban 回转数	4,300
Circumferential Speed Kelajuan 圆周速度	80m/s
Engine Power Kuasa Enjin 发动机功率	3.0kW/ 4.1PS
Fuel Tank Capacity Tangki Minyak 油箱容量	1.1L
Dimensions (L x W x H) Dimensi 体积	780x310x455mm (30-3/4"x12-1/4"x17-7/8")
Net Weight Berat Bersih 净重	14.2kg (31.3lbs)

EK7301 355mm (14")

Power Cutter
Pemotong Berkuasa
汽油切断机



- High performance and powerful Engine
Enjin berprestasi tinggi dan berkuasa
高性能和强力的引擎

Standard Equipment: Cutting Disc, Socket Wrench



Sembarang stok, mesin 80cc 售完即止
WHILE STOCK LAST
可國空機 80cc 售完即止

Wheel Diameter Diameter Roda 轮片直径	355mm (14")
Engine Enjin 发动机	73mL
Max Cutting Depth Kedalaman Pemotongan Maksimum 最大切割深度	122mm (4-13/16")
Circumferential Speed Kelajuan 圆周速度	80m/s
Engine Power Kuasa Enjin 发动机功率	3.8kW/ 5.1PS
Fuel Tank Capacity Tangki Minyak 油箱容量	1.1L
Dimensions (L x W x H) Dimensi 体积	770x290x370mm (30-1/4"x11-3/8"x14-1/2")
Net Weight Berat Bersih 净重	10.1kg (22.3lbs)

EK6101 355mm (14")

Power Cutter
Pemotong Berkuasa
汽油切断机



- Smaller hub and drive wheel for increases maximum cutting depth
Hab kecil dan roda pemacu untuk meningkatkan pemotongan kedalaman maksimum
较小的轮毂和驱动轮可增加最大切割深度

Standard Equipment: Cutting Disc, Wrenches, Screwdriver



Wheel Diameter Diameter Roda 轮片直径	355mm (14")
Engine Enjin 发动机	61mL
Max Cutting Depth Kedalaman Pemotongan Maksimum 最大切割深度	130mm (5-1/8")
No Load Speed (RPM) Kelajuan Tanpa Beban 回转数	4,400
Circumferential Speed Kelajuan 圆周速度	80m/s
Engine Power Kuasa Enjin 发动机功率	3.2kW/ 4.4PS
Fuel Tank Capacity Tangki Minyak 油箱容量	0.7L
Overall Length Dimensi 体积	730mm (28-3/4")
Net Weight Berat Bersih 净重	8.8kg (19.4lbs)

Cordless
Tangan Boleh Beraksi

LED Flashlight
Lampu Flash LED
LED 闪光灯

Vacuum Cleaner
Pembersih Vakuam
吸尘器

Drilling / Fastening
Gores / Pengetat
电钻 / 螺絲

Impact Drilling / Demolition
Gores / Penebuk
电钻 / 电錘

Cutting
Pemotong
切割

Grinding / Sanding
Penggosok / Sanding
打磨 / 磨粉

Sawing
Gores
切割

Planing / Routing
Penggosok / Penggosok
刨 / 修边

Others
Lain-lain
其他

Outdoor Power Equipment
Alatan Kuasa Luar
户外动力设备

Makita
Makita

OUTDOOR POWER EQUIPMENT



VARIOUS OPTIONS
Pelbagai pilihan
各种选择

- Trigger gun set
Part No. 197842-2
- Variable nozzle set
Part No. 197822-8
- Cyclone jet nozzle set
Part No. 197824-4
- Cyclone guard set
Part No. 197864-2
- Variospray lance set
Part No. 197876-5
- Under body spray lance set
Part No. 198909-9
- Extension pipe set
Part No. 197870-7
- Rotating brush set
Part No. 197831-7
- Wash brush set
Part No. 197828-6
- Foam nozzle set
Part No. 197886-2
- Pipe cleaning hose
Part No. 197837-5
- Self-suction hose set
Part No. 197873-1

- Cardless
Tempa Mula Boleh
- LED Flashlight
Lampu Suka LED
LE508 B12
- Vacuum Cleaner
Penyedut Vakum
VC250
- Drilling / Fastening
Gergaji / Pengikat
M15 / M16
- Impact Drilling / Demolition
Gergaji / Pemukul
M15, M16 / M18, M20
- Cutting
Pemotong
UM1
- Grinding / Sanding
Pengisar / Habis
M18 / M20
- Sawing
Gergaji
M12
- Planing / Routing
Pecutan / Tempung
M20 / M25
- Others
Lain-lain
M18
- Outdoor Power Equipment
Alatan Kuasa Luar
M18, M20, M25



OUTDOOR POWER EQUIPMENT

HW1300

High Pressure Washer

Pembersih Tekanan Tinggi
高压清洗机



- **Eco-friendly for reduced water**
Mesra alam dengan pengurangan kegunaan air
环保与减少用水量

Standard Equipment: Trigger Gun, Vario-Power Spray Lance, Cyclone jet nozzle, Detergent Bottle, Cleaner Pin, Coupling Sleeve, High Pressure Hose 10m, Water Hose Connector, Foam Nozzle, Connector



Continuous Rating Input Input Kuasa Berterusan 额定输入功率	1,800W
Max Pressure Tekanan Maksimum 最大水压	13MPa (130bar, 1,885PSI)
Max Flow Rate Aliran Air Maksimum 最大流量	420L/h
Max Input Temperature Ketahanan Suhu Air 最大输入温度	40°C (104°F)
High Pressure Hose Length Hos Tekanan 高压软管长度	10m (33ft.)
Dimensions (L x W x H) Dimensi 体积	292x358x830mm (11-1/2"x14-1/8"x32-3/4")
Net Weight Berat Bersih 净重	12.7kg (28.0lbs.)
Power Supply Cord Kabel Wayer 电源线	5.0m (16.4ft.)

HW1200

High Pressure Washer

Pembersih Tekanan Tinggi
高压清洗机



- **Uses up to 80% less water than a garden hose while delivering up to 50X the pressure**
Memberikan tekanan 50 kali ganda lebih daripada hos biasa dan menjimatkan 80% penggunaan air berbanding dengan hos biasa
用水量比园艺胶管少80%，同时可提供高达50倍的水压力

Standard Equipment: Trigger Gun, Vario-Power Spray Lance, Cyclone jet nozzle, Detergent Bottle, Cleaner Pin, Coupling Sleeve, High Pressure Hose 10m, Water Hose Connector, Foam Nozzle, Connector



Continuous Rating Input Input Kuasa Berterusan 额定输入功率	1,800W
Max Pressure Tekanan Maksimum 最大水压	12MPa (120bar, 1,740PSI)
Max Flow Rate Aliran Air Maksimum 最大流量	420L/h
Max Input Temperature Ketahanan Suhu Air 最大输入温度	40°C (104°F)
High Pressure Hose Length Hos Tekanan 高压软管长度	10m (33 ft.)
Dimensions (L x W x H) Dimensi 体积	292x358x830mm (11-1/2"x14-1/8"x32-3/4")
Net Weight Berat Bersih 净重	11.0kg (24.3lbs.)
Power Supply Cord Kabel Wayer 电源线	5.0m (16.4ft.)

HW121

High Pressure Washer

Pembersih Tekanan Tinggi
高压清洗机



- **Made for frequent usage on larger, dirty or very dirty areas**
Sesuai untuk pembersihan kerap di tempat yang luas dan kotoran yang degil
适用于清洗较大的面积和极度肮脏的地方

HW102

High Pressure Washer

Pembersih Tekanan Tinggi
高压清洗机



- **Lightweight and compact power washer for home**
Ringan dan padat, sesuai untuk kegunaan rumah
轻量家用高压清洗机



Continuous Rating Input Kuasa 额定输入功率	2,100W
Max Pressure Tekanan Maksimum 最大水压	13MPa (130bar, 1,885PSI)
Max Flow Rate Aliran Air Maksimum 最大流量	390L/h
Motor Type Enjin 马达类型	Induction
Max Input Temperature Ketahanan Suhu Air 最大输入温度	50°C (122°F)
High Pressure Hose Length Hos Tekanan 高压软管长度	8m (26.3ft.)
Net Weight Berat Bersih 净重	17.8kg (39.2lbs.)

Continuous Rating Input Kuasa 额定输入功率	1,300W
Max Pressure Tekanan Maksimum 最大水压	10MPa (100bar, 1,450PSI)
Max Flow Rate Aliran Air Maksimum 最大流量	360L/h
Motor Type Enjin 马达类型	Universal
Max Input Temperature Ketahanan Suhu Air 最大输入温度	50°C (122°F)
High Pressure Hose Length Hos Tekanan 高压软管长度	5m (16.4ft.)
Net Weight Berat Bersih 净重	5.8kg (12.8lbs.)

EW3051H | EW2051H 169mL 4-stroke

Pump

Pam
汽油水泵



- **4-stroke for low noise and low emission**
4 strok untuk bunyi rendah dan pelepasan asap yang rendah
四冲程低噪音，低排气

Standard Equipment: Hose coupling, Hose band, Strainer, Hex Wrench



Displacement Sesaran 排量	169mL
Suction & Discharge Diameter Sedutan dan Diameter Paip 吸管与排管直径	80mm (3") EW3051H 50mm (2") EW2051H
Max Pumping Capacity Kapasiti Pemomputan Maksimum 最大泵水能力	1,000L/min (33,800gal/min) EW3051H 700L/min (23,700gal/min) EW2051H
Total Head Mesin 机头	23m (75ft)
Fuel Tank Capacity Tangki Minyak 油箱容量	3.2L
Max Suction Head Mesin Sedutan 吸头	8m (26ft)
Engine Model Enjin 发动机	EX17 EW3051H EX16 EW2051H
Dimensions (L x W x H) Dimensi 体积	527x368x417mm (20-3/4"x14-1/2"x16-3/8")
Net Weight Berat Bersih 净重	26.1kg (57.6lbs) EW3051H 24.9kg (54.9lbs) EW2051H



Cordless
Terdapat Kordless

LED Flashlight
Lampu Suluh LED
LED 照燈

Vacuum Cleaner
Pembersih Vakum
吸尘器

Drilling | Fastening
Gerudi | Pengikat
钻孔 | 紧固

Impact Drilling | Demolition
Gerudi | Pemecah
石工钻孔 | 凿裂加工

Cutting
Pemotong
切割

Grinding | Sanding
Pengisar | Pelsin
研磨 | 打磨

Sawing
Gergaji
锯切

Planing | Routing
Pergesam | Tanggam
刨削 | 雕刻

Others
Lain-lain
其他

Outdoor Power Equipment
Alatan Kerja Luar
园机·户外

M6501G 6.5mm (1/4")

85

High Speed DrillGerudi Kelajuan Tinggi
高速钻

- **Ideal for drilling smaller holes in wood & steel**
Sesuai untuk pengerudian lubang lebih kecil pada bahan kayu atau logam
适用于木材和钢材上钻孔



Standard Equipment: Chuck Key

**Continuous Rating Input**

Input Kuasa Berterusan 额定输入功率

230W

Capacity

Kapasiti 能力

Steel: 6.5mm (1/4")

Wood: 9mm (11/32")

No Load Speed (RPM)

Kelajuan Tanpa Beban 回转数

0 - 4,500

Dimensions (L x W x H)

Dimensi 体积

203x63x171mm

(8"x2-1/2"x6-3/4")

Net Weight

Berat Bersih 净重

0.95kg (2.1lbs)

Power Supply Cord

Kabel Wayar 电源线

2.0m (6.6ft.)

M0600G 10mm (3/8")

64

DrillGerudi
电钻

- **Powerful 350W motor for continuous operation**
Motor berkuasa 350W untuk operasi berterusan
强力350W马达可持续运作



Standard Equipment: Chuck Key, Chuck Key Holder

**Continuous Rating Input**

Input Kuasa Berterusan 额定输入功率

350W

Capacity

Kapasiti 能力

Steel: 10mm (3/8")

Wood: 20mm (13/16")

No Load Speed (RPM)

Kelajuan Tanpa Beban 回转数

0 - 3,000

Dimensions (L x W x H)

Dimensi 体积

230x66x176mm

(9"x2-5/8"x6-15/16")

Net Weight

Berat Bersih 净重

1.2kg (2.6lbs)

Power Supply Cord

Kabel Wayar 电源线

2.0m (6.6ft.)

M6001G 10mm (3/8")

85

DrillGerudi
电钻

- **Powerful 450W motor for continuous operation**
Motor berkuasa 450W untuk operasi berterusan
强力450W马达可持续运作



Standard Equipment: Chuck Key

**Continuous Rating Input**

Input Kuasa Berterusan 额定输入功率

450W

Capacity

Kapasiti 能力

Steel: 10mm (3/8")

Wood: 25mm (1")

No Load Speed (RPM)

Kelajuan Tanpa Beban 回转数

0 - 3,000

Dimensions (L x W x H)

Dimensi 体积

229x64x175mm

(9"x2-1/2"x6-7/8")

Net Weight

Berat Bersih 净重

1.3kg (2.9lbs)

Power Supply Cord

Kabel Wayar 电源线

2.0m (6.6ft.)

M6200G 13mm (1/2")

303

DrillGerudi
电钻

- **Powerful 800W motor with variable speed for improved mixing and drilling performance**
Motor berkuasa 800W dengan Pilihan kawalan kelajuan berubah untuk prestasi pencampuran dan pengerudian yang lebih baik
强力800W马达配备变速控制功率提高混合和钻孔性能



Standard Equipment: Chuck Key, Top Grip

**Continuous Rating Input**

Input Kuasa Berterusan 额定输入功率

800W

Capacity

Kapasiti 能力

Steel: 13mm (1/2")

Wood: 36mm (1-7/16")

No Load Speed (RPM)

Kelajuan Tanpa Beban 回转数

0 - 700

Dimensions (L x W x H)

Dimensi 体积

267x86x388mm

(10-1/2"x3-3/8"x15-1/4")

Net Weight

Berat Bersih 净重

2.7kg (6.0lbs.)

Power Supply Cord

Kabel Wayar 电源线

2.0m (6.6ft.)

M6600XG

303

MixerPengadun
搅拌机

- **Powerful 800W motor for improved mixing and drilling performance**
Motor berkuasa 800W untuk prestasi pencampuran dan pengerudian yang lebih baik
强力800W马达提高混合和钻孔性能



Come with



Standard Equipment: Mixing Blade, Shaft, Top Grip, Wrenches

**Continuous Rating Input**

Input Kuasa Berterusan 额定输入功率

800W

Blade Diameter

Diameter Bilah 锯片直径

165mm (6-1/2")

No Load Speed (RPM)

Kelajuan Tanpa Beban 回转数

0 - 700

Dimensions (L x W x H)

Dimensi 体积

280x86x388mm

(11"x3-3/8"x15-1/4")

Net Weight

Berat Bersih 净重

2.6kg (5.7lbs.)

Power Supply Cord

Kabel Wayar 电源线

2.0m (6.6ft.)



M8103G 13mm (1/2") 85

Hammer Drill

Gerudi Tukul
冲击电钻



- 2-mode operation for hammering with rotation or rotation only
Operasi 2 mod, penukulan dengan putaran atau hanya putaran
2档模式变换, 旋转并锤击或仅旋转

Standard Equipment: Chuck Key, Side Grip, Chuck Key Holder



Continuous Rating Input Input Kuasa Berterusan 额定输入功率	430W
Capacity Kapasiti 能力	Concrete: 13mm (1/2") Steel: 13mm (1/2") Wood: 18mm (11/16")
Impacts Per Minute (IPM) Impak Per Minit 冲击数	0 - 33,000
No Load Speed (RPM) Kelajuan Tanpa Beban 回转数	0 - 3,000
Dimensions (L x W x H) Dimensi 体积	255x72x193mm (10"x2-13/16"x7-5/8")
Net Weight Berat Bersih 净重	1.8kg (3.9lbs)
Power Supply Cord Kabel Wayar 电源线	2.0m (6.6ft)

M8081G 16mm (5/8") 85

Hammer Drill

Gerudi Tukul
冲击电钻



- 2-mode operation for hammering with rotation or rotation only
Operasi 2 mod, penukulan dengan putaran atau hanya putaran
2档模式变换, 旋转并锤击或仅旋转

Standard Equipment: Chuck Key, Side Grip



Continuous Rating Input Input Kuasa Berterusan 额定输入功率	500W
Capacity Kapasiti 能力	Concrete: 16mm (5/8") Steel: 13mm (1/2") Wood: 20mm (13/16")
Impacts Per Minute (IPM) Impak Per Minit 冲击数	0 - 48,000
No Load Speed (RPM) Kelajuan Tanpa Beban 回转数	0 - 3,200
Dimensions (L x W x H) Dimensi 体积	261x69x195mm (10-1/4"x2-3/4"x7-5/8")
Net Weight Berat Bersih 净重	1.7kg (3.7lbs)
Power Supply Cord Kabel Wayar 电源线	2.0m (6.6ft)

M8100G 16mm (5/8") 85

Hammer Drill

Gerudi Tukul
冲击电钻



- 2-mode operation for hammering with rotation or rotation only
Operasi 2 mod, penukulan dengan putaran atau hanya putaran
2档模式变换, 旋转并锤击或仅旋转

Standard Equipment: Chuck Key, Side Grip, Depth Gauge



Continuous Rating Input Input Kuasa Berterusan 额定输入功率	710W
Capacity Kapasiti 能力	Concrete: 16mm (5/8") Steel: 13mm (1/2") Wood: 30mm (1-3/16")
Impacts Per Minute (IPM) Impak Per Minit 冲击数	0 - 48,000
No Load Speed (RPM) Kelajuan Tanpa Beban 回转数	0 - 3,200
Dimensions (L x W x H) Dimensi 体积	296x77x202mm (11-5/8"x3"x8")
Net Weight Berat Bersih 净重	2.1kg (4.6lbs.)
Power Supply Cord Kabel Wayar 电源线	2.0m (6.6ft.)

M8700G 22mm (7/8") 459

Rotary Hammer

Tukul Putar
电锤



- 2-mode operation for hammering with rotation or rotation only
Operasi 2 mod, penukulan dengan putaran atau hanya putaran
2档模式变换, 旋转并锤击或仅旋转

Standard Equipment: Side Grip, Depth Gauge



Continuous Rating Input Input Kuasa Berterusan 额定输入功率	710W
Impact Energy Kekuatan Impak 单次最大锤击力	EPTA-Procedure 05/2009: 1.9J Our experimental conditions: N/A J
Capacity Kapasiti 能力	Concrete: 22mm (7/8") Core Bit: 54mm (2-1/8") Diamond Core Bit (Dry Type): 65mm (2-9/16") Steel: 13mm (1/2") Wood: 32mm (1-1/4")
Impacts Per Minute (IPM) Impak Per Minit 冲击数	0 - 4,350
No Load Speed (RPM) Kelajuan Tanpa Beban 回转数	0 - 1,100
Dimensions (L x W x H) Dimensi 体积	362x71x194mm (14-1/4"x2-13/16"x7-5/8")
Net Weight Berat Bersih 净重	2.5 - 2.9kg (5.6 - 6.4lbs)
Power Supply Cord Kabel Wayar 电源线	4.0m (13.1ft.)

M8701X3G 459

Combination Hammer

Tukul Kombinasi
冲击电钻电锤



- 3-mode operating - rotation only, hammering with rotation, hammering only
Operasi 3 mod: hanya putaran, penukulan dengan putaran, hanya penukulan
3档模式变换: 仅旋转, 旋转并锤击, 仅锤击

Standard Equipment: Side Grip, Depth Gauge, Drill Chuck, SDS-Plus Chisel Assortment 3pcs Set (D-30134)



Continuous Rating Input Input Kuasa Berterusan 额定输入功率	800W
Impact Energy Kekuatan Impak 单次最大锤击力	EPTA-Procedure 05/2009: 2.3J Our experimental conditions: N/A J
Capacity Kapasiti 能力	Concrete : 26mm (1") Core Bit: 68mm (2-11/16") Diamond Core Bit (Dry Type): 80mm (3-1/8") Steel : 13mm (1/2") Wood : 32mm (1-1/4")
Impacts per minute (ipm) Impak Per Minit 冲击数	0-4,500
No Load Speed (RPM) Kelajuan Tanpa Beban 回转数	0-1,200
Dimensions (L x W x H) Dimensi 体积	362x71x194mm (14-1/4"x2-13/16"x7-5/8")
Net Weight Berat Bersih 净重	2.7kg (6.0lbs)
Power Supply Cord Kabel Wayar 电源线	4.0m (13.1ft)

Cordless
Tanpa Kord 无绳式

LED Flashlight
Lampu Suhu LED
LED照明灯

Vacuum Cleaner
Pembersih Vakuum
吸尘器

Drilling / Fastening
Gerudi / Pengikat
钻孔 / 紧固

Impact Drilling / Demolition
Gerudi / Pemecah
石工钻孔 / 凿裂加工

Cutting
Pemotong
切割

Grinding / Sanding
Pengisar / Pelsin
研磨 / 打磨

Sawing
Gergaji
锯切

Planing / Routing
Pengaliran / Tumpang
刨削 / 雕刻

Others
Lain-lain
其他

Outdoor Power Equipment
Alatan Kerja Luar
园机/户外



M8600G 17mm (11/16") Hex Shank

105

Demolition Hammer

 Tukul Elektrik
电动锤

- Satisfactory chipping performance
Prestasi penyerpahan yang memuaskan
卓越碎石性能



Standard Equipment: Bull Point, Side Grip



Continuous Rating Input Input Kuasa Berterusan 额定输入功率	900W
Impact Energy Kekuatan Impak 单次最大锤击力	7.2J
Impacts Per Minute (IPM) Impak Per Minit 冲击数	2,900
Dimensions (L x W x H) Dimensi 体积	406x99x232mm (16"x3-7/8"x9-1/8")
Net Weight Berat Bersih 净重	5.4kg (12lbs)
Power Supply Cord Kabel Wayar 电源线	2.5m (8.2ft)

M9509G

Toggle Switch

Suis Togol 后置式开关

M9513G

Slide Switch

Suis Gelangsar 滑动开关

325

M9509G | M9513G 100mm (4")

Angle Grinder
Pengisar Sudut 角向磨光机

- Powerful 850W motor for the most demanding applications
Motor berkuasa 850W untuk aplikasi yang paling mencabar
强力850W马达适合严峻使用

 Standard Equipment: M9509G: Side Grip, Lock Nut Wrench
M9513G: Side Grip

Continuous Rating Input Input Kuasa Berterusan 额定输入功率	850W
Wheel Diameter Diameter Roda 轮片直径	100mm (4")
No Load Speed (RPM) Kelajuan Tanpa Beban 回转速	11,000
Dimensions (L x W x H) Dimensi 体积	276x118x101mm M9509G 273x118x101mm M9513G (10-3/4"x4-5/8"x4")
Net Weight Berat Bersih 净重	1.8kg (3.9lbs)
Power Supply Cord Kabel Wayar 电源线	2.0m (6.6ft)

M9506G

Toggle Switch

Suis Togol 后置式开关

M9512G

Slide Switch

Suis Gelangsar 滑动开关

459

M9506G | M9512G 100mm (4")

Angle Grinder
Pengisar Sudut 角向磨光机

- Powerful 720W motor for the most demanding applications
Motor berkuasa 720W untuk aplikasi yang paling mencabar
强力720W马达适合严峻使用

Standard Equipment: Side Grip, Lock Nut Wrench



Continuous Rating Input Input Kuasa Berterusan 额定输入功率	720W
Wheel Diameter Diameter Roda 轮片直径	100mm (4")
No Load Speed (RPM) Kelajuan Tanpa Beban 回转速	11,000
Dimensions (L x W x H) Dimensi 体积	261x118x101mm M9506G 258x118x101mm M9512G (10-1/8"x4-5/8"x4")
Net Weight Berat Bersih 净重	1.6kg (3.6lbs)
Power Supply Cord Kabel Wayar 电源线	2.0m (6.6ft)

M0900G

Toggle Switch

Suis Togol 后置式开关

M0910G

Top Slide Switch

 Suis Gelangsar Atas 顶部滑动开关
Convenient for left & right handed
Mudah diguna dengan tangan
kiri atau kanan 方便左右手

459

M0900G | M0910G 100mm (4")

Angle Grinder
Pengisar Sudut 角向磨光机

- High performance and durability
Prestasi dan ketahanan tinggi
高性能与持久耐用

Standard Equipment: Lock Nut Wrench



Continuous Rating Input Input Kuasa Berterusan 额定输入功率	540W
Wheel Diameter Diameter Roda 轮片直径	100mm (4")
No Load Speed (RPM) Kelajuan Tanpa Beban 回转速	12,000
Dimensions (L x W x H) Dimensi 体积	251x118x97mm M0900G 251x118x93mm M0910G (9-7/8"x4-5/8"x3-13/16") (9-7/8"x4-5/8"x3-5/8")
Net Weight Berat Bersih 净重	1.6kg (3.5lbs)
Power Supply Cord Kabel Wayar 电源线	2.0m (6.6ft)

M9504G 100mm (4") 411

Angle Grinder
Pengisar Sudut
角向磨光机

Toggle Switch
Suis Togol 后置式开关

- **High performance and durability**
Prestasi dan ketahanan tinggi
高性能与持久耐用

Standard Equipment:
Lock Nut Wrench

WHEEL DIAMETER
Diameter Roda | 轮片直径
4"
(100mm)

Continuous Rating Input Input Kuasa Berterusan 额定输入功率	570W
Wheel Diameter Diameter Roda 轮片直径	100mm (4")
No Load Speed (RPM) Kelajuan Tanpa Beban 回转数	12,000
Dimensions (L x W x H) Dimensi 体积	256x118x92mm (10-1/8"x4-5/8"x3-5/8")
Net Weight Berat Bersih 净重	1.8kg (4.0lbs.)
Power Supply Cord Kabel Wayar 电源线	2.0m (6.6ft)

M9511G 125mm (5") 325

Angle Grinder
Pengisar Sudut
角向磨光机

Slide Switch
Suis Gelasar 滑动开关

- **Slimmer barrel grip with easy gripping and handling**
Memberikan prestasi kawalan unggul dan keselesaan
提供更优异的控制性能和舒适度

Standard Equipment:
Side Grip, Lock Nut Wrench

WHEEL DIAMETER
Diameter Roda | 轮片直径
5"
(125mm)

Continuous Rating Input Input Kuasa Berterusan 额定输入功率	850W
Wheel Diameter Diameter Roda 轮片直径	125mm (5")
No Load Speed (RPM) Kelajuan Tanpa Beban 回转数	11,000
Dimensions (L x W x H) Dimensi 体积	276x140x111mm (10-7/8"x5-1/2"x4-3/8")
Net Weight Berat Bersih 净重	2.0kg (4.5lbs)
Power Supply Cord Kabel Wayar 电源线	2.0m (6.6ft)

M9508G 125mm (5") 459

Angle Grinder
Pengisar Sudut
角向磨光机

Slide Switch
Suis Gelasar 滑动开关

- **Compact and lightweight for high production work**
Kompak dan ringan untuk kerja pengeluaran yang tinggi
紧凑轻巧型，更有效率地工作

Standard Equipment:
Side Grip, Lock Nut Wrench, Wheel Cover

WHEEL DIAMETER
Diameter Roda | 轮片直径
5"
(125mm)

Continuous Rating Input Input Kuasa Berterusan 额定输入功率	720W
Wheel Diameter Diameter Roda 轮片直径	125mm (5")
No Load Speed (RPM) Kelajuan Tanpa Beban 回转数	11,000
Dimensions (L x W x H) Dimensi 体积	261x140x111mm (10-1/4"x5-1/2"x4-3/8")
Net Weight Berat Bersih 净重	1.9kg (4.1lbs)
Power Supply Cord Kabel Wayar 电源线	2.0m (6.6ft)

M9503G 125mm (5") 411

Angle Grinder
Pengisar Sudut
角向磨光机

Top Slide Switch
Suis Gelasar Atas 顶部滑动开关
Convenient for left & right handed
Mudah diguna dengan tangan kiri atau kanan 方便左右手

- **Ideal for welders, fabricators, masons, maintenance/ repair and more**
Ideal untuk pengimpal, fabrikasi, tukang batu, penyelenggaraan atau pembaikan dan banyak lagi
适用于焊工，制造商，泥瓦匠，维修与修理等

Standard Equipment:
Side Grip, Lock Nut Wrench

WHEEL DIAMETER
Diameter Roda | 轮片直径
5"
(125mm)

Continuous Rating Input Input Kuasa Berterusan 额定输入功率	570W
Wheel Diameter Diameter Roda 轮片直径	125mm (5")
No Load Speed (RPM) Kelajuan Tanpa Beban 回转数	11,000
Dimensions (L x W x H) Dimensi 体积	270x140x110mm (10-5/8"x5-1/2"x4-5/16")
Net Weight Berat Bersih 净重	2.0kg (4.4lbs)
Power Supply Cord Kabel Wayar 电源线	2.0m (6.6ft)

M9002G 125mm (5") 303

Angle Grinder
Pengisar Sudut
角向磨光机

Trigger Switch
Suis Pemicu 扳机开关

- **High performance and durability**
Prestasi dan ketahanan tinggi
高性能与持久耐用

Standard Equipment:
Side Grip, Lock Nut Wrench

WHEEL DIAMETER
Diameter Roda | 轮片直径
5"
(125mm)

Continuous Rating Input Input Kuasa Berterusan 额定输入功率	1,050W
Wheel Diameter Diameter Roda 轮片直径	125mm (5")
No Load Speed (RPM) Kelajuan Tanpa Beban 回转数	11,000
Dimensions (L x W x H) Dimensi 体积	361x140x124mm (14-1/4"x5-1/2"x4-7/8")
Net Weight Berat Bersih 净重	2.8kg (6.1lbs.)
Power Supply Cord Kabel Wayar 电源线	2.0m (6.6ft)

Cordless
Tanpa Kord 无绳式

LED Flashlight
Lampu Suluh LED
LED照明灯

Vacuum Cleaner
Pembersih Vakuum
吸尘器

Drilling | Fastening
Cendul | Pengikat
钻孔 | 紧固

Impact Drilling | Demolition
Gerudi | Pemecah
石工钻孔 | 凿裂加工

Cutting
Pemotong
切割

Grinding | Sanding
Pengisar | Pelsin
研磨 | 打磨

Sawing
Gergaji
锯切

Planing | Routing
Pengaliran | Tanggaman
刨削 | 雕刻

Others
Lain-lain
其他

Outdoor Power Equipment
Alatan Kerja Luar
园林户外

M9000G 180mm (7")

204

Angle Grinder

 Pengisar Sudut
角向磨光机

- **Powerful 2,000W motor for the most demanding applications**
Motor berkuasa 2,000W untuk aplikasi yang paling mencabar
强力2,000W马达适合严峻使用

Trigger Switch
Suis Pemicu 扳机开关

Standard Equipment:
Side Grip, Lock Nut Wrench

Continuous Rating Input Input Kuasa Berterusan 额定输入功率	2,000W
Wheel Diameter Diameter Roda 轮片直径	180mm (7")
No Load Speed (RPM) Kelajuan Tanpa Beban 回转数	8,500
Dimensions (L x W x H) Dimensi 体积	466x200x138mm (18-3/8"x7-7/8"x5-7/16")
Net Weight Berat Bersih 净重	5.4kg (12.0lbs.)
Power Supply Cord Kabel Wayar 电源线	2.0m (6.6ft.)

M9001G 230mm (9")

204

Angle Grinder

 Pengisar Sudut
角向磨光机

- **Powerful 2,000W motor for the most demanding applications**
Motor berkuasa 2,000W untuk aplikasi yang paling mencabar
强力2,000W马达适合严峻使用

Trigger Switch
Suis Pemicu 扳机开关

Standard Equipment:
Side Grip, Lock Nut Wrench

Continuous Rating Input Input Kuasa Berterusan 额定输入功率	2,000W
Wheel Diameter Diameter Roda 轮片直径	230mm (9")
No Load Speed (RPM) Kelajuan Tanpa Beban 回转数	6,600
Dimensions (L x W x H) Dimensi 体积	466x250x138mm (18-3/8"x9-7/8"x5-7/16")
Net Weight Berat Bersih 净重	5.7kg (12.6lbs.)
Power Supply Cord Kabel Wayar 电源线	2.0m (6.6ft.)

M9400G 100mm (4")

153

Belt Sander

 Pengampelas
带式砂光机

- **Powerful 940W motor for faster material removal**
Motor berkuasa 940W untuk pengisaran yang lebih cepat
功率强大的940W马达提供更快的研磨

Standard Equipment: Abrasive Belt, Dust Bag (1233280),
Carbon Plate, Step

Continuous Rating Input Input Kuasa Berterusan 额定输入功率	940W
Belt Size Saiz Tali Pinggang 皮带尺寸	100 x 610mm (4" x 24")
Belt Speed Kelajuan Tali Pinggang 皮带速度	380m/min (1,250ft/min)
Dimensions (L x W x H) Dimensi 体积	354x175x169mm (14"x6-7/8"x6-5/8")
Net Weight Berat Bersih 净重	6.2kg (13.7lbs.)
Power Supply Cord Kabel Wayar 电源线	2.0m (6.6ft.)

M9204G 125mm (5")

419

Random Orbit Sander

 Pengampelas
砂光机

- **Available with dust bag and also connectable to vacuum cleaners without adapter**
Dengan beg debu dan juga boleh disambungkan ke pembersih vakum tanpa penyesuai
配有防尘袋且可连接到没有连接器的吸尘器

Standard Equipment: Dust Bag, Abrasive Paper

Continuous Rating Input Input Kuasa Berterusan 额定输入功率	240W
Pad Size Saiz Pad 垫大小	123mm (4-7/8")
Abrasive Paper Size Saiz Kertas Pasir 砂纸尺寸	125mm (5")
Orbits Per Minute (OPM) Bilangan Putaran 轨道转数	12,000
Strokes Per Minute (SPM) Kelajuan Strok 冲程速度	24,000
Orbit Diameter Jejaki Diameter 轨道直径	2.8mm (1/8")
Dimensions (L x W x H) Dimensi 体积	153x123x144mm (6"x4-7/8"x5-5/8")
Net Weight Berat Bersih 净重	1.2kg (2.6lbs)
Power Supply Cord Kabel Wayar 电源线	2.0m (6.6ft)

M9202G

419

Random Orbit Sander

 Pengampelas
砂光机

- **Rocker on/off switch for efficient operation**
Suis gelangsar untuk operasi yang cekap
滑动式按钮开关有效操作

Standard Equipment: Abrasive Paper

Continuous Rating Input Input Kuasa Berterusan 额定输入功率	240W
Pad Size Saiz Pad 垫大小	123mm (4-7/8")
Abrasive Disc Size Saiz Cakera 磨盘尺寸	125mm (5")
Orbits Per Minute (OPM) Bilangan Putaran 轨道转数	12,000
Strokes Per Minute (SPM) Kelajuan Strok 冲程速度	24,000
Orbit Diameter Jejaki Diameter 轨道直径	2.8mm (1/8")
Dimensions (L x W x H) Dimensi 体积	127x123x142mm (5"x4-7/8"x5-5/8")
Net Weight Berat Bersih 净重	1.1kg (2.4lbs)
Power Supply Cord Kabel Wayar 电源线	2.0m (6.6ft)

M9200G

419

Finishing Sander
Pengampelas
砂光机

- 14,000OPM for fast and smooth finish sanding
14,000OPM untuk pelicin dengan cepat
14000OPM用于快速研磨



Standard Equipment: Abrasive paper



Continuous Rating Input Input Kuasa Berterusan 额定输入功率	180W
Pad Size Saiz Pad 垫大小	112 x 102mm (4-3/8" x 4")
Abrasive Paper Size Saiz Kertas Pasir 砂纸尺寸	114 x 140mm (4-1/2" x 5-1/2")
Orbits Per Minute (OPM) Bilangan Putaran 轨道转速	14,000
Dimensions (L x W x H) Dimensi 体积	110x112x133mm (4-5/16"x4-3/8"x5-1/4")
Net Weight Berat Bersih 净重	0.9kg (2lbs)
Power Supply Cord Kabel Wayar 电源线	2.0m (6.6ft)

M9201G

64

Finishing Sander
Pengampelas
砂光机

- Compact and lightweight body for better handling
Padat dan ringan
小巧轻便的机身易于操纵



Standard Equipment: Abrasive Paper



Continuous Rating input Input Kuasa Berterusan 额定输入功率	180W
Pad Size Saiz Pad 垫大小	93 x 185mm (3-5/8" x 7-1/4")
Abrasive Paper Size Saiz Kertas Pasir 砂纸尺寸	93 x 228mm (3-5/8" x 9")
Orbits Per Minute (OPM) Bilangan Putaran 轨道转速	12,000
Dimensions (L x W x H) Dimensi 体积	214x92x147mm (8-3/8"x3-5/8"x5-3/4")
Net Weight Berat Bersih 净重	1.4kg (3.1lbs)
Power Supply Cord Kabel Wayar 电源线	2.0m (6.6ft)

M5801G 185mm (7-1/4")

303

Circular Saw
Gergaji Piring
圆锯

- High performance and durability
Prestasi dan ketahanan tinggi
高性能兼耐用



Standard Equipment: TCT Saw Blade, Guide Rule, Hex Wrench



Continuous Rating Input Input Kuasa Berterusan 额定输入功率	1,050W
Blade Diameter Diameter Roda 轮片直径	185mm (7-1/4")
Max Cutting Capacity Kapasiti Pemotongan Maksimum 最大切割能力	90°: 66mm (2-5/8") 45°: 44mm (1-3/4")
No Load Speed (RPM) Kelajuan Tanpa Beban 回转速数	4,900
Dimensions (L x W x H) Dimensi 体积	284x231x243mm (11-1/8"x9-1/8"x9-9/16")
Net Weight Berat Bersih 净重	3.5kg (7.7lbs)
Power Supply Cord Kabel Wayar 电源线	2.0m (6.6ft)

M2300G 255mm (10")

500

Compound Miter Saw
Gergaji Kompaun Miter
斜断锯

- Powerful 1,500W motor
Motor berkuasa 1,500W
强力1,500W马达



Standard Equipment: Wrench, Dust Bag, Triangular Rule, Vice Assembly, Set Plate, Verticle Vise



Continuous Rating Input Input Kuasa Berterusan 额定输入功率	1,500W
Blade Diameter Diameter Bilah 锯片直径	255mm (10")
Miter Angle Sudut Miter 斜接角	45°L / 45°R
Bevel Angle Sudut Bevel 斜角	45°L
Max Cutting Capacity Kapasiti Pemotongan Maksimum 最大切割能力	90° Miter: 75 x 130mm (2-15/16" x 5-1/8") 45° Miter, L/R: 75 x 90mm (2-15/16" x 3-9/16")
No Load Speed (RPM) Kelajuan Tanpa Beban 回转速数	4,200
Dimensions (L x W x H) Dimensi 体积	610x485x515mm (24"x19-1/8"x20-1/4")
Net Weight Berat Bersih 净重	14.7kg (32.5lbs)
Power Supply Cord Kabel Wayar 电源线	2.5m (8.2ft)

M4302G

411

Jig Saw
Gergaji Jig
线锯机

- Heavy duty aluminum gear housing for increased durability
Gear aluminum tugas berat untuk meningkatkan ketahanan
重型铝制齿轮组件结构提高耐用性



Standard Equipment: 2x Jig Saw Blade (B-13 & No. 51), Hex Wrench



Continuous Rating Input Input Kuasa Berterusan 额定输入功率	450W
Max Cutting Capacity at 90° Kapasiti Pemotongan Maksimum 最大切割能力	Wood: 55mm (2-3/16") Steel: 6mm (1/4")
Length of Stroke Panjang Strok 冲程长度	26mm (1")
Strokes Per Minute (SPM) Kelajuan Strok 冲程速度	0 - 3,100
Dimensions (L x W x H) Dimensi 体积	219x85x191mm (8-5/8"x3-3/8"x7-1/2")
Net Weight Berat Bersih 净重	2.5kg (5.5lbs.)
Power Supply Cord Kabel Wayar 电源线	2.0m (6.6ft.)

Cordless
Tempa Kord 无绳式

LED Flashlight
Lampu Suluh LED
LED照明灯

Vacuum Cleaner
Pembersih Vakuum
吸尘器

Drilling | Fastening
Ceculi | Pengecat
钻孔 | 紧固

Impact Drilling | Demolition
Gerudi | Pemecah
石工钻孔 | 拆毁加工

Cutting
Pemotong
切割

Grinding | Sanding
Pengisar | Pelsin
研磨 | 打磨

Sawing
Gergaji
锯切

Planing | Routing
Pengaliran | Tenggaman
刨削 | 雕刻

Others
Lain-lain
其他

Outdoor Power Equipment
Alatan Kerja Luar
园机/户外

Makita
—mt—

M4301G

64

Jig Saw
Gergaji Jig
线锯机

- **Powerful 450W motor**
Motor berkuasa 450W
强力450W马达

Standard Equipment: Jig Saw Blade (B-10), Hex Wrench

Continuous Rating Input Input Kuasa Berterusan 额定输入功率	450W
Max Cutting Capacity at 90° Kapasiti Pemotongan Maksimum 最大切割能力	Wood: 65mm (2-9/16") Steel: 6mm (1/4")
Length of Stroke Panjang Strok 冲程长度	18mm (11/16")
Strokes Per Minute (SPM) Kelajuan Strok 冲程速度	0 - 3,100
Dimensions (L x W x H) Dimensi 体积	214x75x202mm (8-3/8"x2-15/16"x8")
Net Weight Berat Bersih 净重	1.9kg (4.1lbs)
Power Supply Cord Kabel Wayar 电源线	2.0m (6.6ft)

M4501G

303

Recipro Saw
Gergaji Resipro
往复锯

- **Powerful 1,010W motor for improved performance**
Motor berkuasa 1,010W untuk prestasi lebih baik
强劲的1,010W马达提高性能



Continuous Rating Input Input Kuasa Berterusan 额定输入功率	1,010W
Length of Stroke Panjang Strok 冲程长度	28mm (1-1/8")
Strokes Per Minute (SPM) Kelajuan Strok 冲程速度	0 - 2,800
Capacity Kapasiti 能力	Pipe : 130mm (5-1/8") Wood: 255mm (10")
Dimensions (L x W x H) Dimensi 体积	457x98x170mm (18"x3-7/8"x6-11/16")
Net Weight Berat Bersih 净重	3.2kg (7lbs)
Power Supply Cord Kabel Wayar 电源线	2.0m (6.6ft)

M0400G 110mm (4-3/8")

303

Cutter
Pemotong
切割机

- **Powerful 1,200W motor**
Motor berkuasa 1,200W
强力1,200W马达

Standard Equipment: Wrench, Hex Wrench
(Tool does not come with Diamond Wheel)

Continuous Rating Input Input Kuasa Berterusan 额定输入功率	1,200W
Blade Diameter Diameter Bilah 锯片直径	110mm (4-3/8")
Max Cutting Capacity Kapasiti Pemotongan Maksimum 最大切割能力	90°: 32mm (1-1/4")
No Load Speed (RPM) Kelajuan Tanpa Beban 回转速数	13,800
Dimensions (L x W x H) Dimensi 体积	224x195x164mm (8-7/8"x7-5/8"x6-1/2")
Net Weight Berat Bersih 净重	2.5kg (5.6lbs.)
Power Supply Cord Kabel Wayar 电源线	2.0m (6.6ft.)

M4100G 110mm (4-3/8")

303

Cutter
Pemotong
切割机

- **Compact and lightweight for reduced operator fatigue**
Kompak dan ringan untuk mengurangkan keletihan pengguna
小巧轻便，减少疲劳

Standard Equipment: Wrench, Hex Wrench, Water Supply Set
(Tool does not come with Diamond Wheel)

Continuous Rating Input Input Kuasa Berterusan 额定输入功率	1,200W
Blade Diameter Diameter Bilah 锯片直径	110mm (4-3/8")
Max Cutting Capacity Kapasiti Pemotongan Maksimum 最大切割能力	90°: 32mm (1-1/4")
No Load Speed (RPM) Kelajuan Tanpa Beban 回转速数	13,000
Dimensions (L x W x H) Dimensi 体积	227x209x166mm (8-15/16"x8-1/4"x6-1/2")
Net Weight Berat Bersih 净重	2.9kg (6.4lbs)
Power Supply Cord Kabel Wayar 电源线	2.0m (6.6ft.)

M2400G 355mm (14")

203

Portable Cut-off
Mesin Pemotong
型材切割机

- **Powerful 2,000W motor**
Motor berkuasa 2,000W
强力2,000W马达

Standard Equipment: Abrasive Cut-Off Wheel, Socket Wrench

Continuous Rating Input Input Kuasa Berterusan 额定输入功率	2,000W
Wheel Diameter Diameter Roda 轮片直径	355mm (14")
No Load Speed (RPM) Kelajuan Tanpa Beban 回转速数	3,800
Dimensions (L x W x H) Dimensi 体积	500x280x620mm (19-3/4"x11"x24-3/8")
Net Weight Berat Bersih 净重	15.7kg (34.6lbs)
Power Supply Cord Kabel Wayar 电源线	2.5m (8.2ft)

M2401G 355mm (14")

203

Portable Cut-off
Mesin Pemotong
型材切割机

- **Large cutting capacity; Cuts up to 127mm (5") round and 102mm (4") x 194mm (7-5/8") rectangular**
Kapasiti pemotongan tinggi
切割能力高



Standard Equipment: Abrasive Cut-Off Wheel, Hex Wrench



Continuous Rating Input Input Kuasa Berterusan 额定输入功率	2,000W
Wheel Diameter Diameter Roda 轮片直径	355mm (14")
No Load Speed (RPM) Kelajuan Tanpa Beban 回转数	3,800
Dimensions (L x W x H) Dimensi 体积	500x280x620mm (19-3/4"x11"x24-3/8")
Net Weight Berat Bersih 净重	13.7kg (30.2lbs.)
Power Supply Cord Kabel Wayar 电源线	2.5m (8.2ft.)

M1100G 82mm (3-1/4")

303

Planer
Planer
电刨

- **Easy blade setting system for fast blade installation**
Sistem pemasangan bilah mudah
刀片易安装系统



Standard Equipment: Planer Blade, Sharpening Holder Assembly (for resharpenable blade), Blade Gauge, Socket Wrench, Guide Rule



Continuous Rating Input Input Kuasa Berterusan 额定输入功率	750W
Planing Width Lebar Pelan 刨削宽度	82mm (3-1/4")
Planing Depth Kedalaman Pelan 刨削深度	3mm (1/8")
No Load Speed (RPM) Kelajuan Tanpa Beban 回转数	18,000
Dimensions (L x W x H) Dimensi 体积	390x175x140mm (15-3/8"x6-7/8"x5-1/2")
Net Weight Berat Bersih 净重	4.6kg (10.2lbs.)
Power Supply Cord Kabel Wayar 电源线	2.0m (6.6ft.)

M1901G | M1902G 82mm (3-1/4")

411

Planer
Planer
电刨

- **High performance and durability**
Prestasi dan ketahanan tinggi
高性能兼耐用



Standard Equipment:
M1901G: Planer Blade, Sharpening Holder Assembly (for resharpenable blade), Blade Gauge, Socket Wrench, Guide Rule
M1902G: Planer Blade, Sharpening Holder Assembly (for resharpenable blade), Blade Gauge, Guide Rule



Continuous Rating Input Input Kuasa Berterusan 额定输入功率	580W
Planing Width Lebar Pelan 刨削宽度	82mm (3-1/4")
Planing Depth Kedalaman Pelan 刨削深度	2mm (1/16") M1901G 1mm (1/32") M1902G
No Load Speed (RPM) Kelajuan Tanpa Beban 回转数	16,000
Dimensions (L x W x H) Dimensi 体积	285x157x160mm (11-1/4"x6-3/16"x6-5/16")
Net Weight Berat Bersih 净重	2.8 - 2.9kg (6.1 - 6.4lbs)
Power Supply Cord Kabel Wayar 电源线	2.0m (6.6ft)

M3600G 12mm (1/2")

203

Router
Pemangkas
雕刻机

- **Conveniently located plunge lock lever for efficient operation**
Pelarasan tui yang mudah untuk operasi yang cekap
便利的插入式锁定杆可实现高效操作



Standard Equipment: Straight Guide, Templet Guide, Guide Holder, Collet Sleeve, Straight Bit, Wrench



Continuous Rating Input Input Kuasa Berterusan 额定输入功率	1,650W
Collet Capacity Kapasiti Collet 夹头直径	12mm (1/2")
Plunge Capacity Kapasiti Plunge 能力	0 - 60mm (0 - 2-3/8")
No Load Speed (RPM) Kelajuan Tanpa Beban 回转数	22,000
Dimensions (L x W x H) Dimensi 体积	284x148x300mm (11-1/8"x5-7/8"x11-3/4")
Net Weight Berat Bersih 净重	5.5kg (12.2lbs.)
Power Supply Cord Kabel Wayar 电源线	2.0m (6.6ft.)

M3601G 6mm (1/4"), 8mm (3/8")

106

Router
Pemangkas
雕刻机

- **Powerful 900W motor**
Motor berkuasa 900W
强力900W马达



Standard Equipment: Straight Guide, Straight Bit (733238-9), Wrench



Continuous Rating Input Input Kuasa Berterusan 额定输入功率	900W
Collet Capacity Kapasiti Collet 夹头直径	6 mm (1/4") 8 mm (3/8")
Plunge Capacity Kapasiti Plunge 能力	0 - 35mm (0 - 1-3/8")
No Load Speed (RPM) Kelajuan Tanpa Beban 回转数	27,000
Dimensions (L x W x H) Dimensi 体积	256x110x218mm (10-1/8"x4-5/16"x8-5/8")
Net Weight Berat Bersih 净重	2.7kg (6.0lbs)
Power Supply Cord Kabel Wayar 电源线	2.0m (6.6ft)

Cordless
Tanpa Kord 无绳式

LED Flashlight
Lampu Suluh LED
LED照明灯

Vacuum Cleaner
Pembersih Vakuum
吸尘器

Drilling | Fastening
Geri | Pengikat
钻孔 | 紧固

Impact Drilling | Demolition
Gerudi | Pemecah
石工钻孔 | 衝撃加工

Cutting
Pemotong
切割

Grinding | Sanding
Pengisar | Pelsin
研磨 | 砂磨

Sawing
Gergaji
锯切

Planing | Routing
Pegolan | Tanggaman
刨削 | 雕刻

Others
Lain-lain
其他

Outdoor Power Equipment
Alatan Kerja Luar
园机/户外

M9800G

459

Multi Tool

Mesin Pemotong Berbilang Fungsi
多功能切割打磨机

• Lightweight Design

Reka bentuk yang padat dan ringan
紧凑轻巧的设计

Standard Equipment: Hex Wrench



Oscillations Per Minute (OPM)

Kelajuan Ayunan 摆动速度

15,000 - 22,000

Oscillation Angle

Sudut Ayunan 摆动角度

Left: 1.6° | Right: 1.6° | Total: 3.2°

Dimensions (L x W x H)

Dimensi 体积

283x68x98mm

(11-1/8"x2-11/16"x3-7/8")

Net Weight

Berat Bersih 净重

1.2 - 1.3kg (2.7 - 3.0 lbs.)

Power Supply Cord

Kabel Wayar 电源线

2.0m (6.6ft)

M3700G 6mm (1/4")

411

Trimmer

Pemangkas
修边雕刻机

• Compact and lightweight body for better handling

Padat dan ringan
小巧轻便的机身易于操纵Standard Equipment: Trimmer Guide, Straight Guide,
Templet Guide, Straight Bit, Chip Deflector, Wrench

Continuous Rating Input

Input Kuasa Berterusan 额定输入功率

530W

Collet Capacity

Kapasiti Collet 夹头直径

6mm (1/4")

Plunge Capacity

Kapasiti Plunge 能力

0 - 42mm (0 - 1-5/8")

No Load Speed (RPM)

Kelajuan Tanpa Beban 回转数

35,000

Dimensions (L x W x H)

Dimensi 体积

82x90x199mm

(3-1/4"x3-1/2"x7-7/8")

Net Weight

Berat Bersih 净重

1.4kg (3.1lbs.)

Power Supply Cord

Kabel Wayar 电源线

2.0m (6.6ft)

M3701G 6mm (1/4")

411

Trimmer

Pemangkas
修边雕刻机

• Aluminium housing for higher durability

Cangkang aluminium untuk ketahanan yang lebih tinggi
铝外壳更高的耐用性Standard Equipment: Trimmer Guide, Straight Guide Assembly,
Templet Guide, Straight Bit (733238A9), Chip Deflector, Wrench

M4000G

85

Blower

Mesin Blower
吹风机

• Compact and lightweight increased operator comfort

Kompak dan ringan operasi yang selesa
小巧轻便操作舒适

Standard Equipment: Nozzle assembly, Sash Nozzle



Continuous Rating Input

Input Kuasa Berterusan 额定输入功率

530W

Air Volume

Isipadu Angin 风量

1.2-2.9m³/min

No Load Speed (RPM)

Kelajuan Tanpa Beban 回转数

8,500 - 16,000

Dimensions (L x W x H)

Dimensi 体积

427x161x212mm

(16-3/4"x6-3/8"x8-3/8")

Net Weight

Berat Bersih 净重

1.5kg (3.4lbs.)

Power Supply Cord

Kabel Wayar 电源线

2.0m (6.6ft)

M4001G

303

Blower

Mesin Blower
吹风机

• Two tools in one; quickly converts to a vacuum for added versatility

Alat 2 dalam 1, vakum dan blower untuk fleksibiliti tambahan
一机2用, 集尘与吹风

Standard Equipment: Nozzle, Dust Bag



Continuous Rating Input

Input Kuasa Berterusan 额定输入功率

600W

Max Air Volume

Isipadu Angin Maksimum 最大风量

0 - 4.1m³/min

Max Air Velocity

Velositi Angin Maksimum 最大风速

0 - 91m/s

Air Pressure

Tekanan Udara 气压

0 - 5.7kPa

No Load Speed (RPM)

Kelajuan Tanpa Beban 回转数

0 - 16,000

Dimensions (L x W x H)

Dimensi 体积

480x185x178mm

(18-7/8"x7-1/4"x7")

Net Weight

Berat Bersih 净重

1.9 - 2.0kg (4.3 - 4.5lbs.)

Power Supply Cord

Kabel Wayar 电源线

2.0m (6.6ft.)

Safety Precautions

Amaran keselamatan 安全须知

When using electric tools, basic safety precautions should always be followed to reduce the risk of fire, electric shock, and personal injury, including the following.

Apabila menggunakan alat kuasa, langkah keselamatan asas harus sentiasa diikuti untuk mengurangkan risiko kebakaran, kejutan elektrik dan kecederaan peribadi, termasuk yang berikut.
使用电动工具时，应始终遵循基本的安全预防措施，以降低火灾，触电和人身伤害的风险，包括以下内容。

KEEP WORK AREA CLEAN.

PASTIKAN TEMPAT KERJA SENTIASA KEMAS 保持工作环境清洁

- Cluttered areas and benches invite injuries.

CONSIDER WORK AREA ENVIRONMENT.

PERSEKITARAN KERJA SELAMAT 确保工作环境安全

- Don't use power tools in damp or wet locations. Keep work area well lit.
- Don't expose power tools to rain. Don't use power tool in presence of flammable liquids or gases.

KEEP CHILDREN AWAY.

JAUHI DARIPADA CAPAIAN KANAK-KANAK 远离儿童

- All visitors should be kept away from work area.
- Don't let visitors touch the tool or extension cord.

STORE IDLE TOOLS.

SIMPANKAN ALAT KERJA 工作完毕把工具收起

- When not in use, tools should be stored in a dry, high of locked up place, out of reach of children.

DON'T FORCE THE TOOL.

MENGGUNAKAN ALAT DENGAN CARA YANG BETUL 不要强制使用工具

- It will do the job better and safer at the rate for which it was intended.

USE THE RIGHT TOOL.

MENGGUNAKAN ALAT YANG BETUL 使用正确的工具

- Don't force small tools or attachments to do the job of a heavy-duty tool.
- Don't use tools for purposes not intended.

DRESS PROPERLY.

BERPAKAIAN DENGAN SESUAI 穿著正确

- Don't wear loose clothing or jewelry. They can be caught in moving parts.
- Rubber gloves and non-skid footwear are recommended when working outdoors. Wear protective hair covering to contain long hair.

USE SAFETY GLASSES.

GUNAKAN GERMIN MATA KESELAMATAN 使用安全眼镜

- Also use face or dust mask if the cutting operation is dusty.

DON'T ABUSE THE CORD.

JANGAN MENYALAHGUNAKAN KORD KUASA 滥用电源线

- Never carry the tool by the cord or yank it to disconnect it from the socket.
- Keep the cord away from heat, oil, and sharp edges.

SECURE WORK.

BEKERJA DENGAN SELAMAT 安全的 Work

- Use clamps or a vise to hold the work. It's safer than using your hand and it frees both hands to operate the tool.

DON'T OVERREACH.

BERDIRI TEGAS APABILA MENGGUNAKAN ALAT 工作时身体要站稳

- Keep proper footing and balance at all times.

MAINTAIN TOOLS WITH CARE.

PEMELIHARAAN ALAT 小心保养工具

- Keep cutting tools sharp and clean for better and safer performance. Follow instructions for lubrication and changing accessories. Inspect tool cord periodically and if damaged, have it repaired by an authorized service facility. Inspect extension cords periodically and replace, if damaged. Keep handles dry, clean and free from oil and grease.

DISCONNECT TOOLS.

PASTIKAN SAMBUNGAN ELEKTRIK DIPUTUSKAN 截断电源

- When not in use, before servicing and when changing accessories such as blades, bits and cutters.

REMOVE ADJUSTING KEYS AND WRENCHES.

PASTIKAN PEMASANGAN SIAP SEBELUM KERJA BERMULA 取下调整钥匙和扳手

- Form the habit of checking to see that keys and adjusting wrenches are removed from the tool before turning it on.

AVOID UNINTENTIONAL STARTING.

ELEKKAN PENGHIDUPAN SECARA TIDAK SENGAJA 意外启动

- Don't carry a plugged-in tool with a finger on the switch.
- Ensure switch is OFF when plugging in.

USE OUTDOOR EXTENSION CORDS.

GUNAKAN KORD SAMBUNGAN LUAR 使用户外延伸线

- When tool is used outdoors, use only extension cords intended for outdoor use.

STAY ALERT.

SENTIASA BERJAGA-JAGA 保持警惕

- Watch what you are doing. Use common sense. Don't operate tool when you are tired.

CHECK DAMAGED PARTS.

SEMAK BAHAGIAN ALAT YANG ROSAK 检查工具损坏的部件

- Before further use of the tool, a guard or other part that is damaged should be carefully checked to determine that it will operate properly and perform its intended function. Check for alignment of moving parts, free running of moving parts, breakage of parts, mounting and any other conditions that may affect its operation. A guard or other part that is damaged should be properly repaired or replaced by an authorized service center unless otherwise indicated in this instruction manual. Have defective switches replaced by an authorized service facility. Don't use the tool if the switch does not turn it on and off.

GUARD AGAINST ELECTRIC SHOCK.

ELEKKAN KEJUTAN ELEKTRIK 防止电击

- Avoid body contact with earthed or grounded surfaces (e.g. pipes, radiators, ranges, refrigerators).

REPLACEMENT PARTS.

MENGGANTIKAN BAHAGIAN ALAT 更换配件

- When servicing a tool, use only identical replacement parts.

VOLTAGE WARNING.

AMARAN VOLTAN 电压警告

- Before connecting the tool to a power source (receptacle, outlet, etc.) Be sure the voltage supplied is the same as that specified on the nameplate of the tool. A power source with voltage greater than that specified for the tool can result in SERIOUS INJURY to the user V as well as damage to the tool. If in doubt, DO NOT PLUG IN THE TOOL. Using a power source with voltage less than the nameplate rating is harmful to the motor.

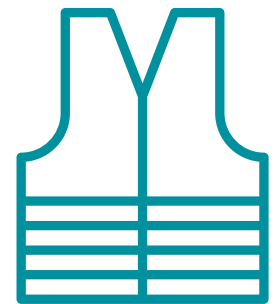

Note Nota 注意

- Makita reserves the right to change specifications of parts and accessories without notice.
- Items of standard equipment and specifications may vary by country or area.
- Net weight and dimensions may differ by the type of battery.
- Standard export color for motor housing is Makita industrial green (blue).
- Please state required voltage when ordering. These offers are subject to availability in each country. Actual product color may differ slightly from color reproduced here.
- Weight data in this catalogue is the value measured by us according to EPTA Procedure 01/ 2003.

Guarantee Jaminan 保证

Every Makita tool is thoroughly inspected and tested before leaving the factory. It is guaranteed against defective workmanship and materials. Should any trouble develop, return the COMPLETE tool prepaid to Makita or point of purchase. If inspection shows trouble is caused by defective workmanship of material, all repairs will be made without charge. The guarantee does not apply where repairs have been made or attempted by others; repairs are due to normal wear; the tool has been abused or in an accident; misuse is evident – caused by overloading the tool beyond its capacity, use of the tool after partial failure or use with improper accessories.



Makita Malaysia



Scan for our location
Press untuk lokasi kami
扫描位置地址

Makita Corporation was founded in 1915 as an electric motor sales and repair company. Makita has grown to become Japan's top manufacturer of portable power tools and recognized leader globally. In May 2013, Makita Malaysia Sales Subsidiary was established in Subang Jaya to provide the best service to cater and satisfy the increased demand and needs of Makita product range in the market. As a cordless tools company, we have the widest range of DC Cordless tools in the market. We envisioned a zero emission working environment with our wide range of DC Cordless Outdoor Power Equipment (DC Cordless OPE), as well as a clean and dustless working environment through our wide range of DC Cordless Cleaner & Vacuum Series. Utilizing the Compact eXtreme Technology (CXT) and Lithium-Ion eXtreme Technology (LXT) in our wide range of DC Cordless tools brings superb and durable performance for professional needs.

Makita Corporation ditubuhkan pada tahun 1915 sebagai syarikat jualan dan pembaikan motor elektrik. Makita telah berkembang menjadi pengilang utama alat-alat kuasa mudah alih dan pemimpin diiktiraf di peringkat global. Pada bulan Mei 2013, Subsidi Jualan Makita Malaysia ditubuhkan di Subang Jaya untuk menyediakan perkhidmatan terbaik untuk memenuhi permintaan pengguna dan memenuhi keperluan produk Makita di pasaran. Sebagai sebuah syarikat jualan peralatan tanpa kord, kami mengimpikan suasana kerja tanpa pencemaran melalui peralatan aktiviti kerja luar Lithium-Ion (Li-ion OPE). Tambahan pula, ia menjadikan persekitaran kerja yang bersih dan tanpa habuk dengan Siri Peralatan Pembersihan kami. Teknologi eXtreme Compact (CXT) dan Teknologi Lithium-Ion eXtreme (LXT) dicipta untuk alatan tanpa kord berprestasi tinggi dan tahan lama supaya memenuhi kehendak golongan profesional.

牧田公司成立于1915年，是一家电动机销售和维修公司。牧田已发展成为日本最大的便携式电动工具制造商，并且是全球公认的领导。2013年5月，牧田马来西亚销售子公司在梳邦再也成立，以提供最佳服务以满足市场上对牧田产品不断增长的需求。通过一系列的锂电园林与户外工具 (Li-ion OPE)，我们致力于实现无排气的工作环境，我们的吸尘器系列，确保各类工业维持干净且无尘的工作环境。我们采用紧凑型极限技术 (CXT) 和锂离子技术 (LXT)，为专业需求打造高效率兼耐用性高的充电式工具。

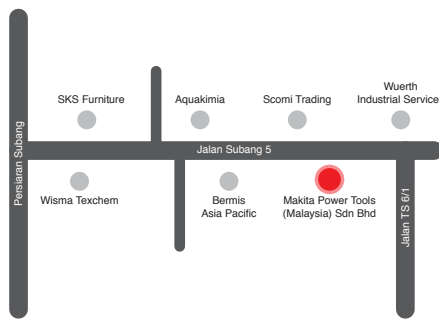

HQ & Service Centre
总部和服务与展示中心
Lot 824, Jalan Subang 5,
Subang Industrial Area,
47500 Subang Jaya, Selangor.
Tel: 03-8023 0824 (General) | Fax: 03-8022 1448
03-8022 1443 (Service)

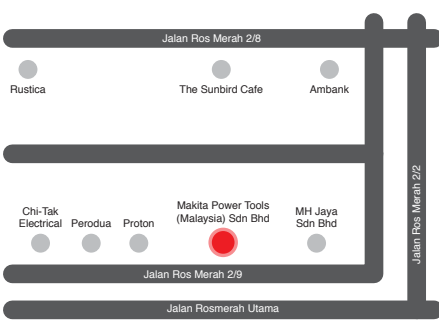

Johor (Johor Bahru) Service Centre
柔佛 (新山) 服务与展示中心
No.12 & 14, Jalan Rosmerah 2/9,
Taman Johor Jaya,
81100 Johor Bahru, Johor.
Tel: 07-364 9406 | Fax: 07-364 9407

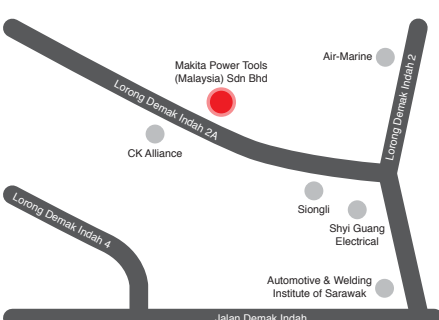

Sarawak (Kuching) Service Centre
砂拉越 (古晋) 服务与展示中心
Lot 1227, Lorong Demak Indah 2A,
Demak Laut Industrial Area, Phase 2A,
93050 Kuching, Sarawak.
Tel: 082-496 800 | Fax: 082-496 900

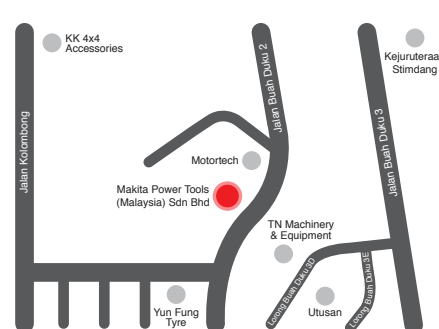

Sabah (Kota Kinabalu) Service Centre
沙巴 (亚庇) 服务与展示中心
Lot 19, Jalan Buah Duku,
Kolombong Light Industrial Estate,
Off Kolombong, Kolombong Zone 1,
88450 Inanam, Kota Kinabalu, Sabah.
Tel: 088-388 278 | Fax: 088-388 279

On-site Demo Service

Perkhidmatan demonstrasi mudah alih 流动示范服务

Our demo cars deliver comprehensive supporting services to customers. To serve customers who are not able to come to our showroom, our professional technical staff will drive the car to your working location. We will introduce products that fit your applications offer product demonstration and technical support according to your special needs. We can also teach you how to maintain your tools.

Kereta demo kami memberikan perkhidmatan sokongan yang komprehensif kepada pelanggan. Untuk memberi perkhidmatan kepada pelanggan yang tidak dapat datang ke bilik pameran kami, kakitangan teknikal profesional kami akan memandu kereta ke lokasi kerja anda. Kami akan memperkenalkan produk yang sesuai dengan aplikasi anda menawarkan demonstrasi produk dan sokongan teknikal mengikut keperluan khusus anda. Kami juga boleh mengajar anda bagaimana mengekalkan alat anda.

我们拥有流动示范服务车为客户提供全面的支持服务。为了协助未能到达我们的陈列室的客户而提供服务，我们的专业技术人员会亲身到您的工作场地。我们将介绍适合您的产品，并根据您的特殊需求提供产品操作示范和技术支持。我们还可以教您如何保养牧田工具的方法等。

FOR ANY ENQUIRIES
PLEASE CONTACT US ON
03-8023 0824



Road Show & Demonstration

Pameran demonstrasi 示范展销会

Come and join us at our roadshow for countless demonstrations on our latest tools and technologies. This is the perfect chance to find out more about our cordless solutions, be there to feel the extreme cordless power!

Datang dan sertai kami di roadshow kami untuk demonstrasi yang tidak terkira banyaknya mengenai alat dan teknologi terkini kami. Ini adalah peluang yang sempurna untuk mengetahui lebih lanjut mengenai penyelesaian tanpa wayar kami, berada di sana untuk merasai kuasa tanpa wayar yang melampau!

快来加入我们的展销会，以展示我们最新的电动工具与技术。这是一个了解更多有关我们的充电式工具解决方案的绝佳机会，在那里您将感受到无与伦比的充电式工具的功能！



Health & Safety Seminar

Seminar Kesihatan & Keselamatan 健康安全讲座

Makita, as a responsible and professional supplier of power tools, always concerns about the health and safety issues of construction workers. Apart from developing products with specific safety features, we also organize seminars for various organizations to educate the workers on work safety and health.

Makita sebagai pembekal alat kuasa yang bertanggungjawab dan profesional, selalu membimbangkan tentang masalah kesihatan dan keselamatan pekerja pembinaan. Selain daripada membangunkan produk dengan ciri keselamatan tertentu, kami juga menganjurkan seminar untuk pelbagai organisasi untuk mendidik pekerja mengenai keselamatan kerja dan kesihatan.

牧田作为一家负责任的专业电动工具生产商，一直都着重工人的健康及安全，并推出了一系列无线·无尘·无火花的工具。为帮助工人更深入地了解如何更安全、健康地工作，本公司会为不同团体或公司举办不同主题的讲座





12 MONTHS WARRANTY

Waranti 12 bulan • 12个月保修期

* Applicable on all Makita Tools, except heat gun (period of 6 months warranty)

* Untuk semua Makita Tool, kecuali Heat Gun (waranti 6 bulan) | *有效于所有 Makita 工具, 热风机除外 (享有6个月保修)

Makita Standard Warranty

Piawaian Waranti Makita • Makita 保修服务说明

Every Makita Product is thoroughly inspected and tested before leaving the factory. Subject to the following terms and conditions, the Product (Tool, Battery, Charger) is warranty against defective materials and manufacturing defects for a period of twelve (12) months from the date of purchase (applicable for purchases made from 1st October 2017 onwards) as evidenced from the sale or tax invoice (with tool serial number) and Makita Authorised Service Centre or Makita Service Centre undertakes, at our option, to repair or replace, free of charge.

Conditions of warranty

This warranty will NOT cover or shall be null & void in any of the following events even during the warranty period:-

1. Damage resulting from normal wear and tear (Carbon brush/ holder/ cap, switch, gear, grinding/ cutting wheels, bits, saw blades, etc.,)
2. Damage resulting from use of improper accessories, non genuine replacement parts, disassembly, tampering, alteration and repairing in any way that affects its performance.
3. Damage resulting from negligence, accident, disaster, improper storage or maintenance, abuse and misuse in evident caused by overloading the tool beyond its capacity.
4. Abnormal voltage or the usage of generator, wrong usage not in accordance with the Operating Manual.
5. If the serial number on the tool, seal on the battery and charger has been defaced or removed.
6. If the receipt or invoice that display the date of purchase could not be present.

Setiap produk Makita diperiksa dan diuji dengan teliti dari kilang. Waranti produk (Alat, Bateri, Pengcas Bateri) tertakluk kepada terma dan syarat berikut, sekiranya terdapat kecacatan pada bahan atau kerosakan disebabkan pembuatan dari kilang dalam tempoh 12 bulan bermula dari tarikh pembelian (untuk pembelian bermula dari 1hb Oktober 2017), dengan bukti pembelian pada resit atau invoice bercukai (dengan nombor siri alat), terikat kepada keputusan Pusat Servis diiktiraf oleh Makita atau Pusat Servis Makita untuk membaiki secara percuma.

Syarat-syarat waranti

Waranti ini TIDAK akan meliputi atau akan dibatalkan & tidak sah sekiranya berlaku salah satu kejadian yang berikut semasa berada dalam tempoh waranti:-

1. Kerosakan akibat daripada haus dan lusuh biasa (karbon/ pemegang/ tukup, suis, gear, cakera mencanai/ memotong, mata gerudi, bilah gergaji, dll.,)
2. Kerosakan akibat daripada penggunaan aksesori yang tidak sesuai, alat ganti yang tidak asli, pembukaan, perbuatan merosakkan, pengubahan dan pembaikan yang mempengaruhi prestasinya.
3. Kerosakan akibat kecauaian, kemalangan, bencana, penyimpanan atau penyelenggaraan yang tidak wajar, penyalahgunaan yang jelas disebabkan oleh beban yang melebihi kemampuannya.
4. Voltan tidak normal atau penggunaan penjana, cara penggunaan yang salah dan tidak mengikut Manual Operasi.
5. Jika nombor siri pada alat, balu/ cap pada bateri dan pengcas tercacat atau ditanggalkan.
6. Jika resit atau invoice yang memaparkan tarikh pembelian tidak dapat ditunjukkan.

每个 Makita 产品生产制造都经过彻底检查和测试并严格把关确认品质。根据以下保修条件, 产品保修 (工具, 电池, 充电器) 涵盖材质和生产上的瑕疵, 于销售单据 (附上工具生产编号) 与税收发票上所显示的购买日期起十二 (12) 个月内 (从 1-10-2017 选购开始), 以 Makita 授权服务中心或 Makita 服务中心的判断为准而提供无收费维修。

保修规定

Makita 均不承担基于以下违反保修行为而造成的产品故障、工作异常或损坏的责任。

1. 正常消耗零件。(例如: 碳刷/支架/盖, 开关, 齿轮, 研磨/切割片, 钻头, 锯片等)。
2. 使用不正确的配件, 更换非原装零件, 拆除和改造等任何影响其性能而引起的损坏。
3. 因人为疏忽, 意外, 灾难, 不正确的保管或保养, 滥用和误用, 超出工具负荷能力等原因导致的损坏。
4. 使用非工具所规定电压和发电机, 未按说明书安装及使用工具。
5. 工具上的编号, 电池和充电器上的印章已被污损或除去。
6. 无法提供销售单据或税收发票。

** Makita reserved the rights of amend conditions of warranty without prior notice. In the event of differences arising between the English, Bahasa Malaysia and Chinese versions, the English version shall prevail.
Makita berhak untuk meminda syarat-syarat waranti pada bila-bila masa tanpa sebarang notis. Jika terdapat perbezaan antara bahasa, maka maklumat versi Bahasa Inggeris harus digunakan.
Makita 保留修改保修规定的权利, 恕不另行通知。如果内容有任何差异或不一致, 概以英文版本为准。



Please visit our website for Authorised Service Centre details

Sila layari laman web kami untuk maklumat Pusat Servis Diiktiraf

请游览我们的网页查询授权服务中心详情

www.makita.my/authorised-service-center

SERVICES • SERVIS • 客户服务
www.makita.my/authorised-service-center

PRODUCT RANGE • RANGKAIAN PRODUK • 产品系列
www.makita.my/product-range

ACCESSORIES • AKSESORI • 配件
www.makita.my/accessories-range

PROMOTION • PROMOSI • 优惠
www.makita.my/promotions

ABOUT US • MENGENAI KAMI • 公司简介
www.makita.my/about-us

LATEST INFO • INFO TERKINI • 最新情报
www.makita.my/latest-news/



TRADEMARK | Tanda Dagangan | 商标



Tanda dagang di atas telah dipatenkan oleh Perbadanan Harta Intelek Malaysia. Makita Power Tools (Malaysia) Sdn. Bhd. berhak untuk mengambil tindakan undang-undang bagi mana-mana pelanggaran tanda dagang di atas, termasuk perkilangan, borong atau menjual sama ada mesin atau aksesori yang dicetak dengan tanda di atas tanpa mendapat kebenaran Makita Power Tools (Malaysia) Sdn. Bhd

上述商标已经在马来西亚知识产权公司办理注册专利。对于任何侵犯上述商标专用权之行为，包括未经许可制造，批发或零售附有上述商标之电动工具及配件，本公司必定追究法律责任。

Above trademarks have been patented at the Intellectual Property Corporation of Malaysia. Makita Power Tools (Malaysia) Sdn. Bhd. reserves the right to take legal action for any infringement of the above trademarks, including manufacturing, wholesale or selling either the power tools or accessories printed with the above trademarks without getting permission of Makita Power Tools (Malaysia) Sdn. Bhd.

*In the event of differences arising between the English, Bahasa Malaysia and Chinese versions, the English version shall prevail.

Jika terdapat perbezaan antara bahasa, maka maklumat versi Bahasa Inggeris harus digunapakai. 如果内容有任何差异或不一致，概以英文版本为准。

*Items of standard equipment and specifications may vary by country or area. Net weight and dimensions may differ depending on the type of battery(ies) used. All pictures shown are for illustration purposes only.

Spesifikasi standard mungkin berbeza mengikut negara. Berat bersih dan dimensi berbeza bergantung pada jenis bateri yang digunakan. Imej yang ditunjukkan hanya untuk tujuan ilustrasi sahaja. 注：规格可能因销往国家之不同而异。重量与尺寸因附件(包括电池组)而异。图片仅供参考。



Makita Power Tools (Malaysia) Sdn. Bhd. Co. Registration No.: 201301001778 (1031615-M)

HQ & Service Centre
总部和服务与展示中心

Lot 824, Jalan Subang 5, Subang Industrial Area,
47500 Subang Jaya, Selangor.
Tel: 03-8023 0824 (General) | Fax: 03-8022 1448
03-8022 1443 (Service)

Johor (Johor Bahru) Service Centre
柔佛(新山)服务与展示中心

No.12 & 14, Jalan Rosmerah 2/9,
Taman Johor Jaya,
81100 Johor Bahru, Johor.
Tel: 07-364 9406 | Fax: 07-364 9407

Sarawak (Kuching) Service Centre
砂拉越(古晋)服务与展示中心

Lot 1227, Lorong Demak Indah 2A,
Demak Laut Industrial Area, Phase 2A,
93050 Kuching, Sarawak.
Tel: 082-496 800 | Fax: 082-496 900

Sabah (Kota Kinabalu) Service Centre
沙巴(亚庇)服务与展示中心

Lot 19, Jalan Buah Duku,
Kolombong Light Industrial Estate, Off Kolombong,
Kolombong Zone 1, 88450 Inanam, Kota Kinabalu, Sabah.
Tel: 088-388 278 | Fax: 088-388 279



www.makita.my
makita@makita.my